

VIN marking area for Santa Cruz model

1. Hood
2. Tail gate
3. Front Fender (LH/RH)
4. Front Door (LH/RH)
5. Rear Door (LH/RH)
6. Side Outer Panel (LH/RH)
7. Front Bumper
8. Rear Bumper
9. Engine
10. Transmission (AT)
11. Transmission (DCT)
12. Pickup box

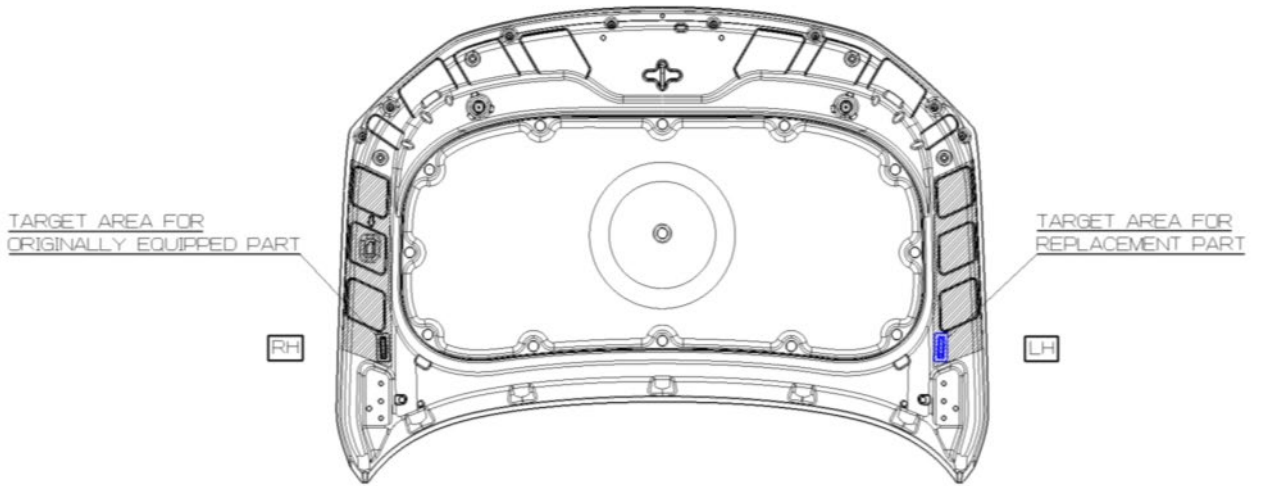

Hood



PNL ASSY-HOOD
(SCALE 3/20)

Tail Gate

TARGET AREA FOR
ORIGINALLY EQUIPPED PART
APPLY ON RH SIDE

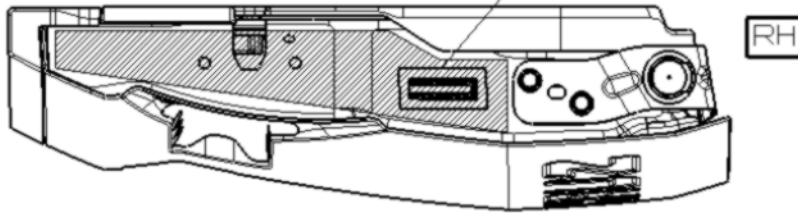

PNL ASSY-T/GATE (RH)
(SCALE 3/10)

TARGET AREA FOR
REPLACEMENT PART
APPLY ON LH SIDE

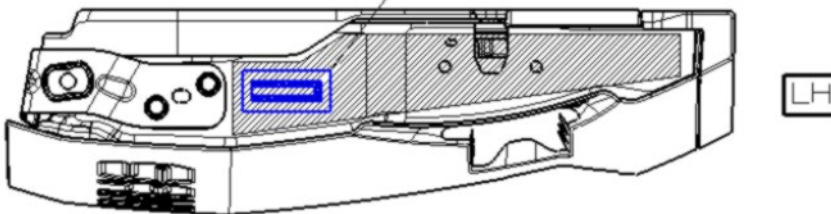

PNL ASSY-T/GATE (LH)
(SCALE 3/10)

Front Fender (LH/RH)

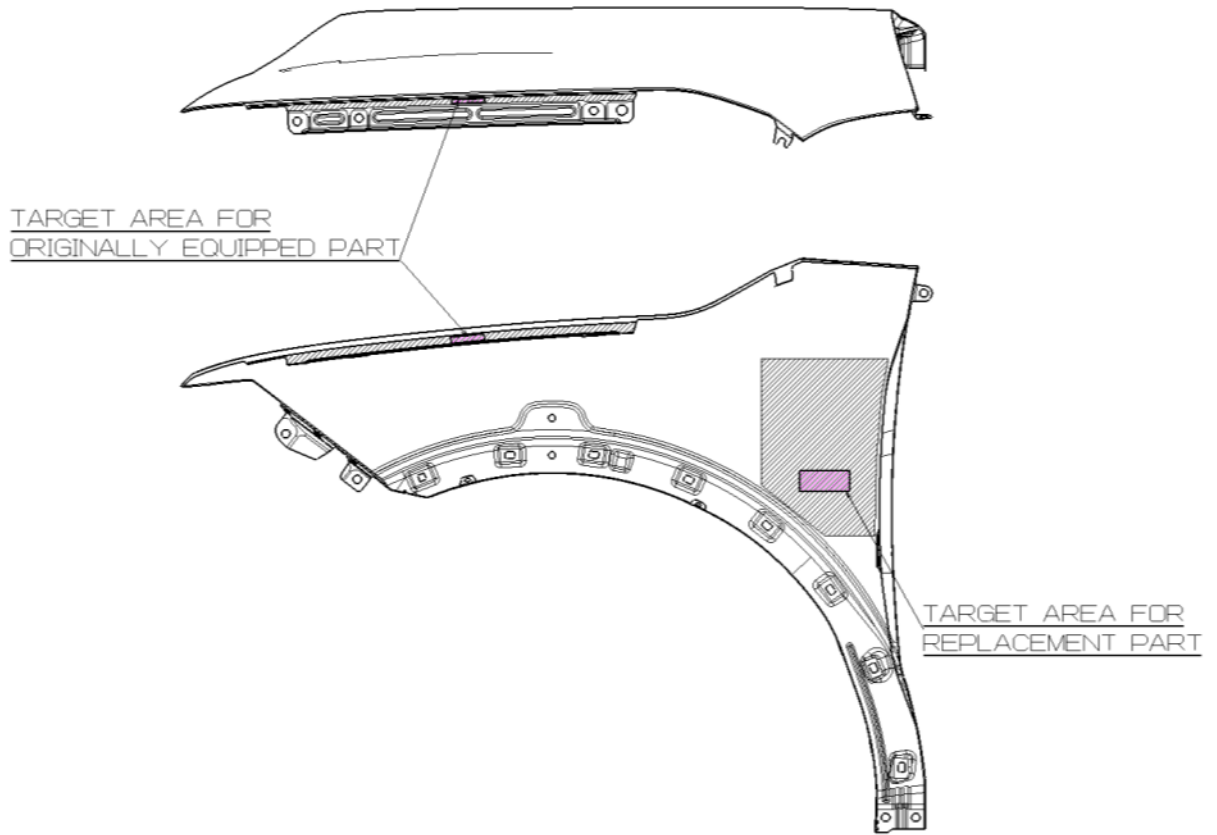

Front Door (LH/RH)

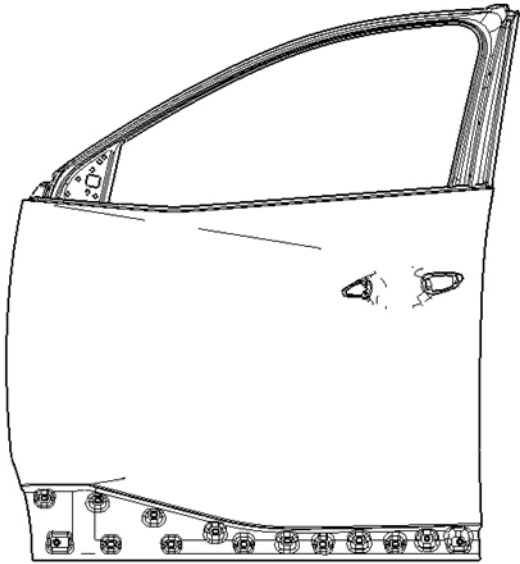

TARGET AREA FOR
ORIGINALLY EQUIPPED PART

TARGET AREA FOR
REPLACEMENT PART

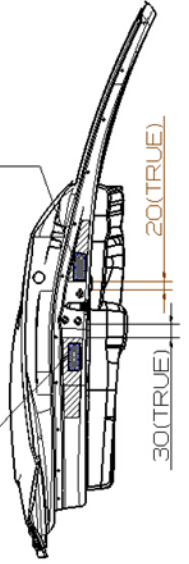

Rear Door (LH/RH)



TARGET AREA FOR
ORIGINALLY EQUIPPED PART

TARGET AREA FOR
REPLACEMENT PART

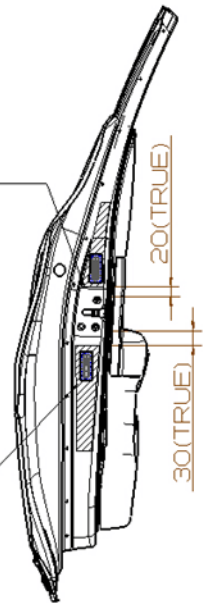

Side Outer Panel (LH/RH)

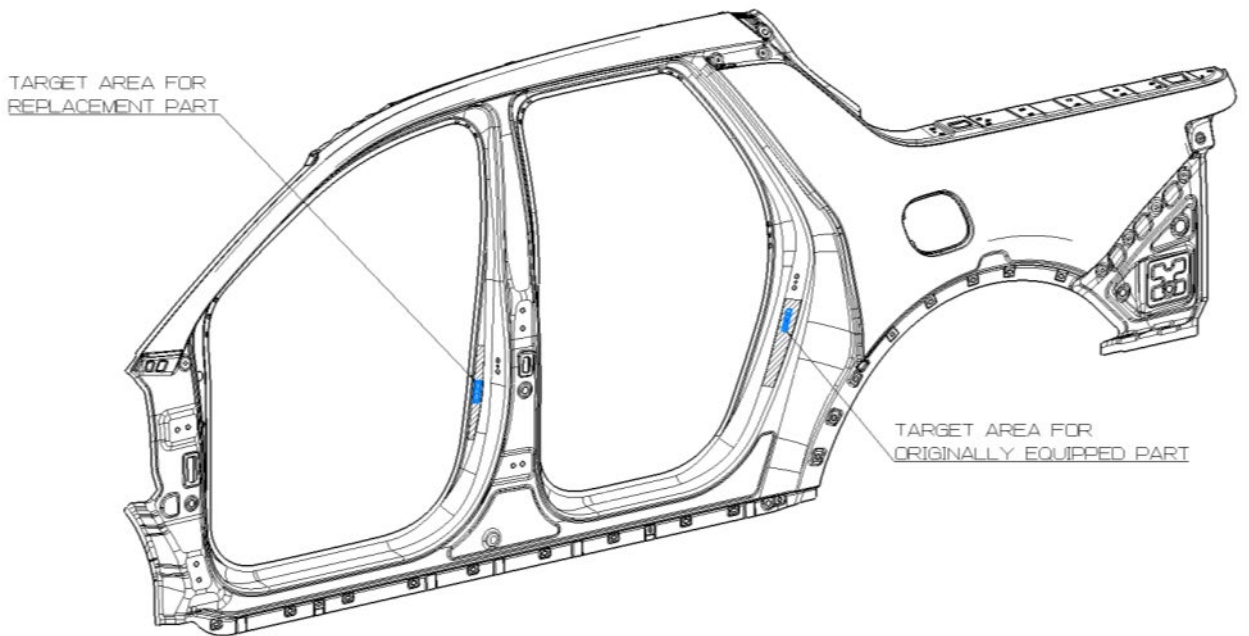

PNL-SIDE OTR, LH/RH

Front Bumper

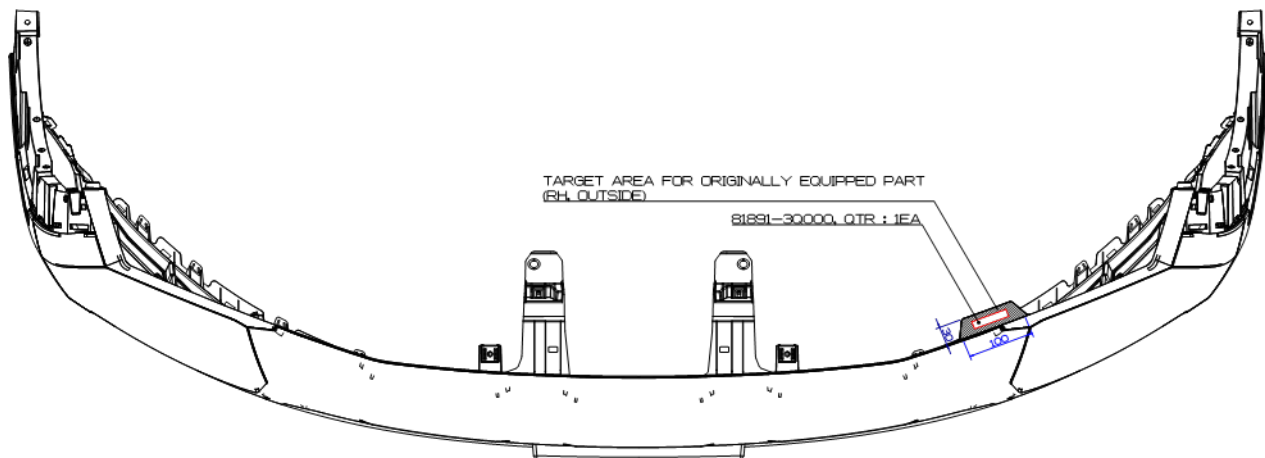

< FRONT BUMPER — BOTTOM VIEW >

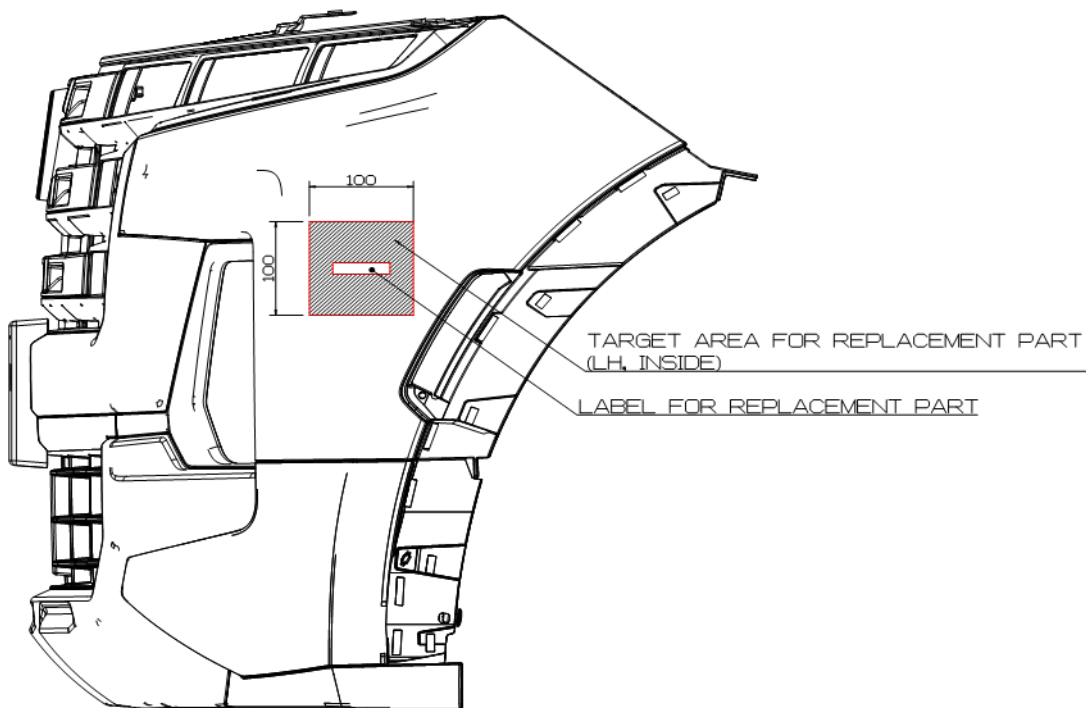

< FRONT BUMPER — SIDE VIEW >

Rear Bumper

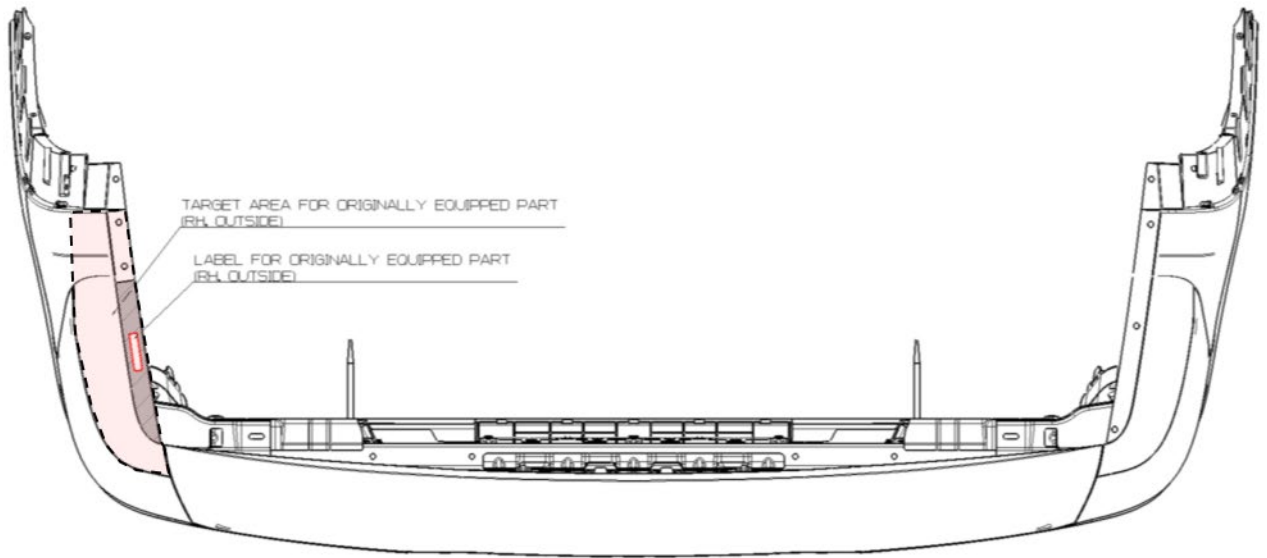

< REAR BUMPER — BOTTOM VIEW >

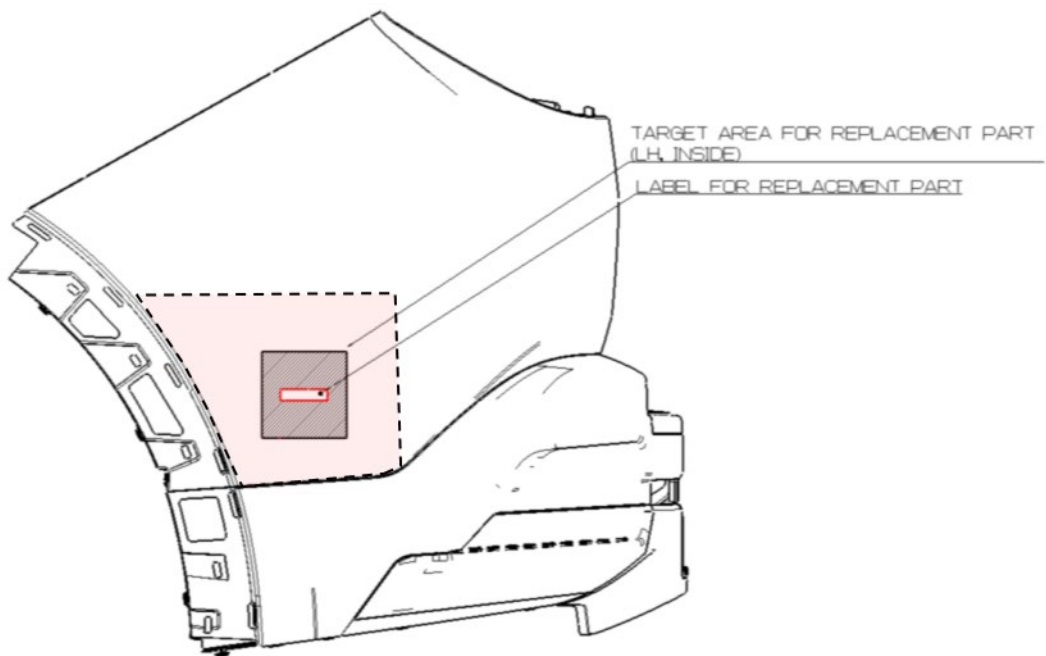

< REAR BUMPER — SIDE VIEW >

Engine (Smartstream G 2.5 GDI/T-GDI)

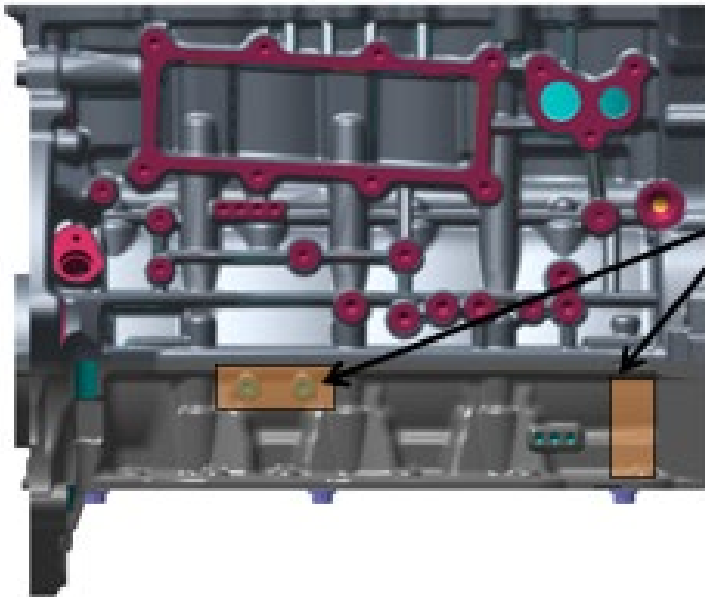

TARGET AREA FOR
ORIGINALLY EQUIPPED PART
(VIN PLATE)

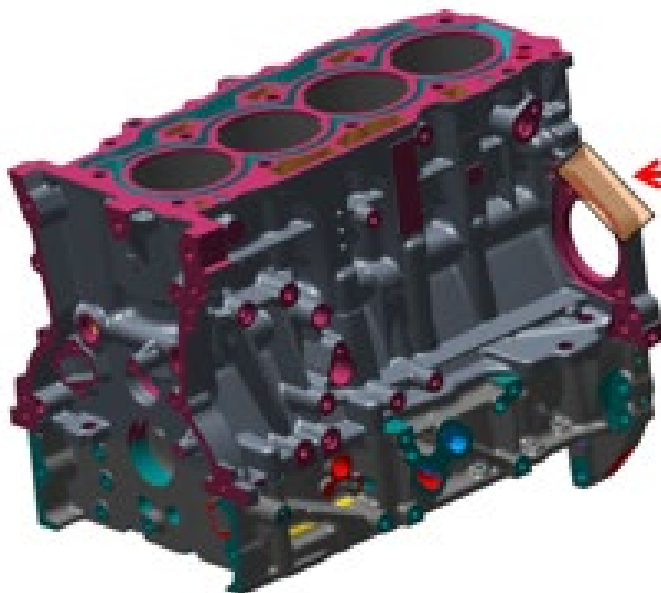

TARGET AREA FOR
REPLACEMENT PART

Transmission (8AT)

TARGET AREA FOR REPLACEMENT PART

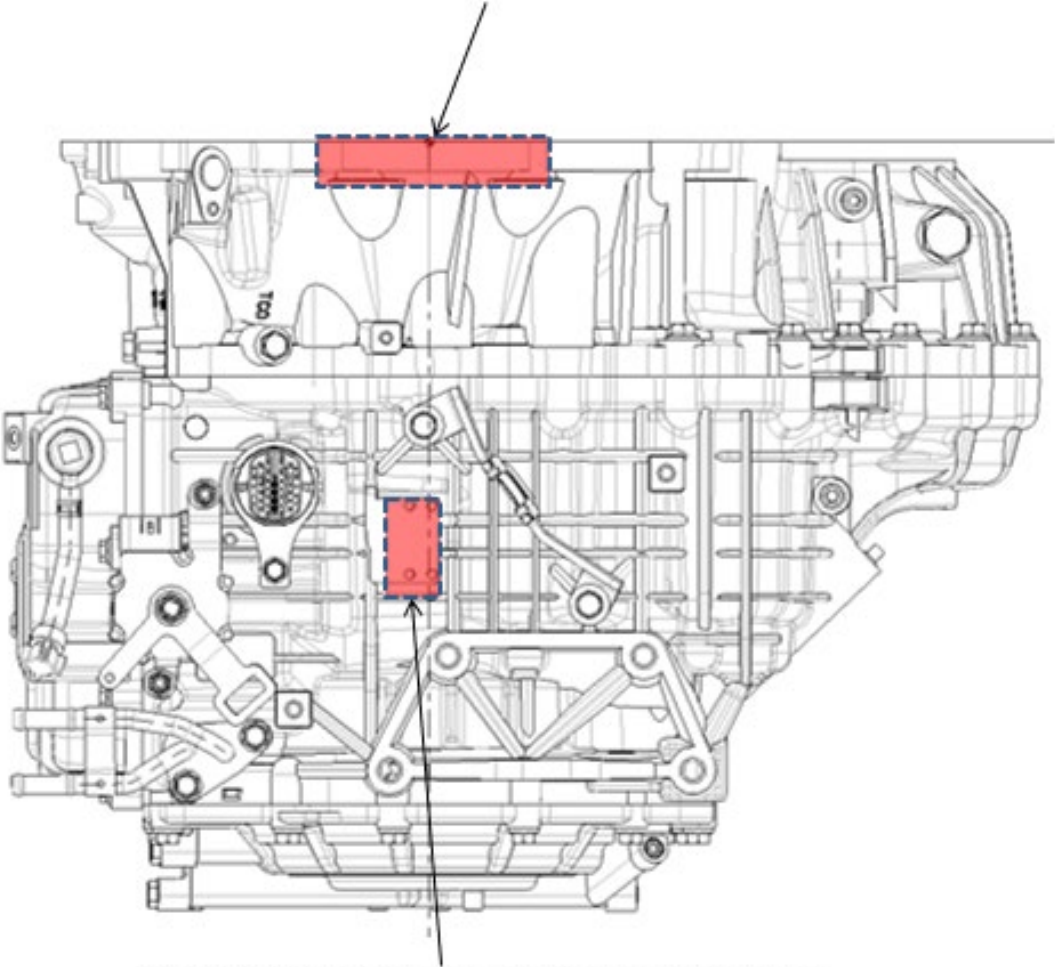

TARGET AREA FOR ORIGINALLY EQUIPPED PART

Transmission (8DCT)

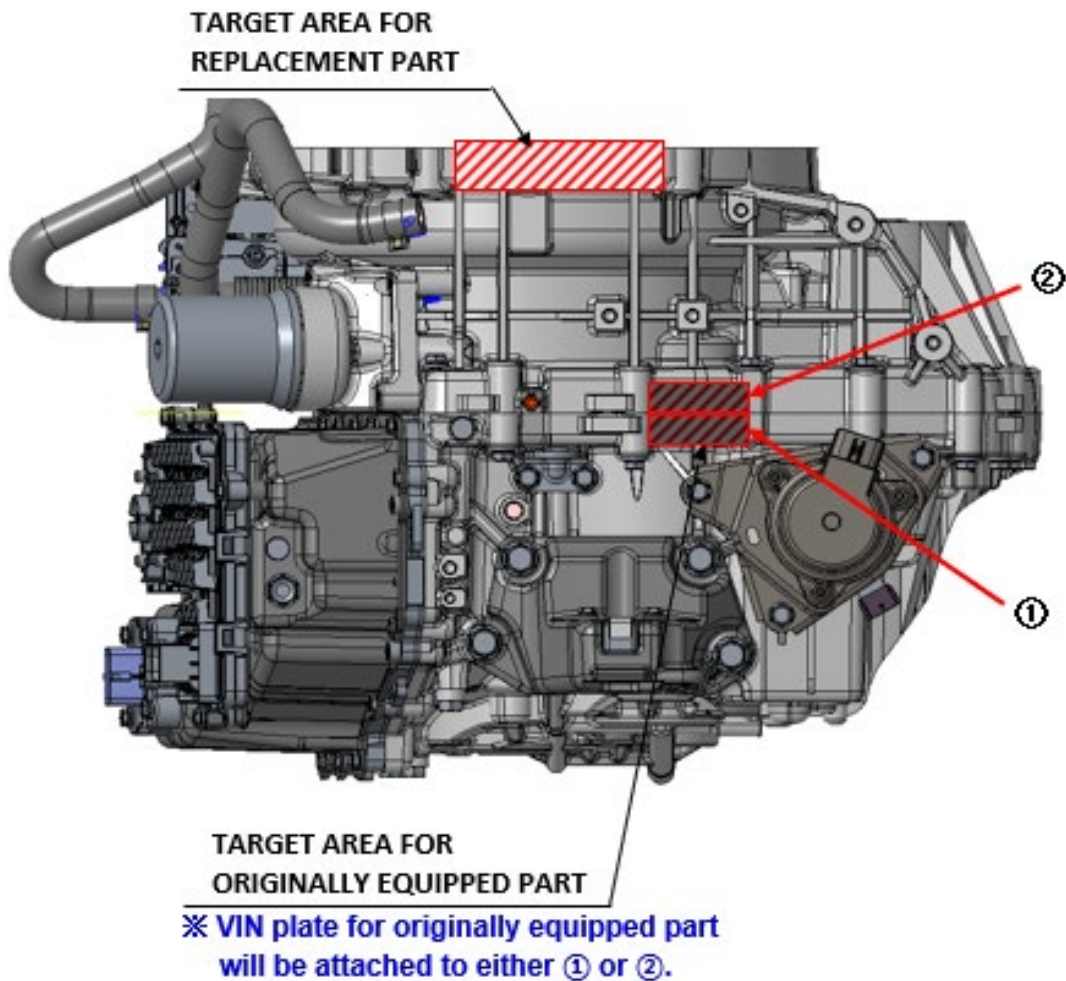

Pickup Box (Floor)

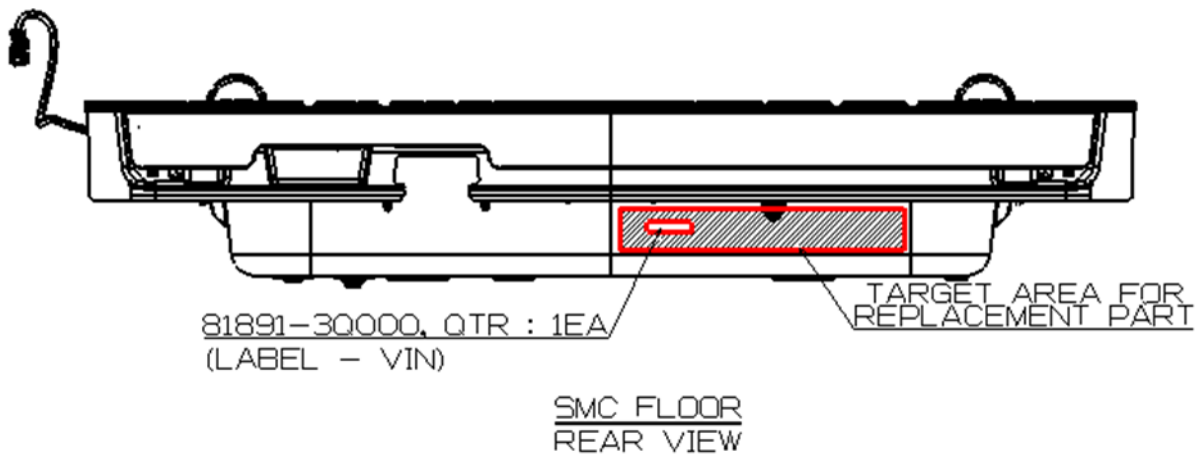
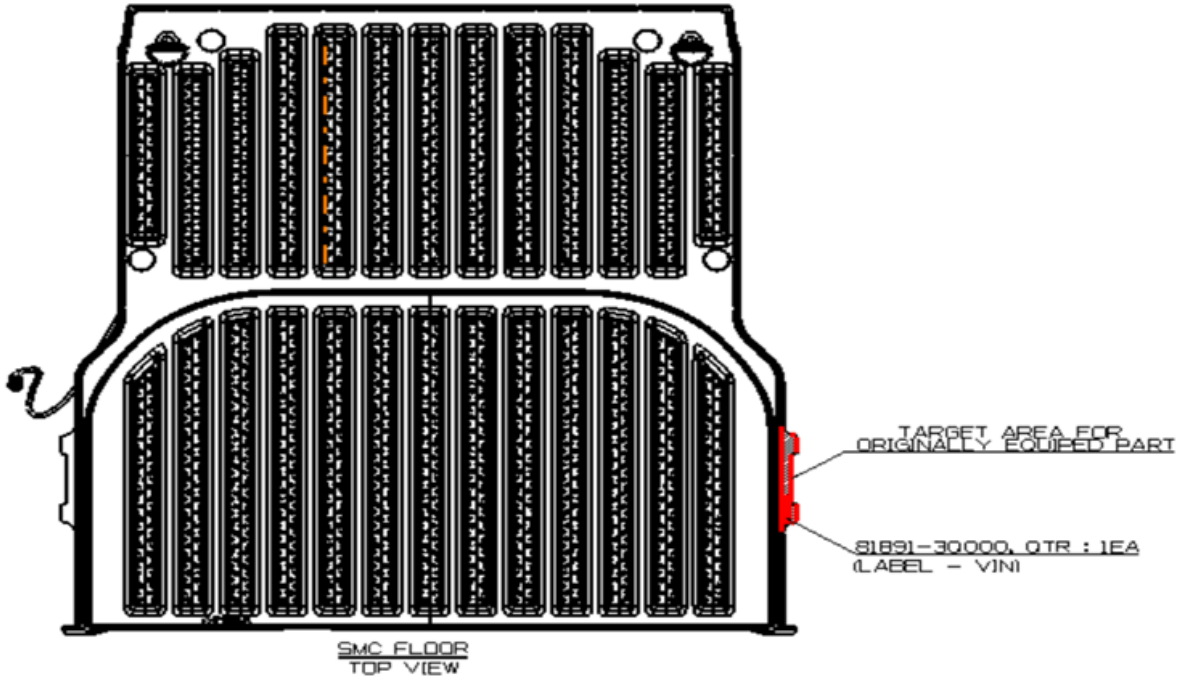

Pickup Box (Lid)

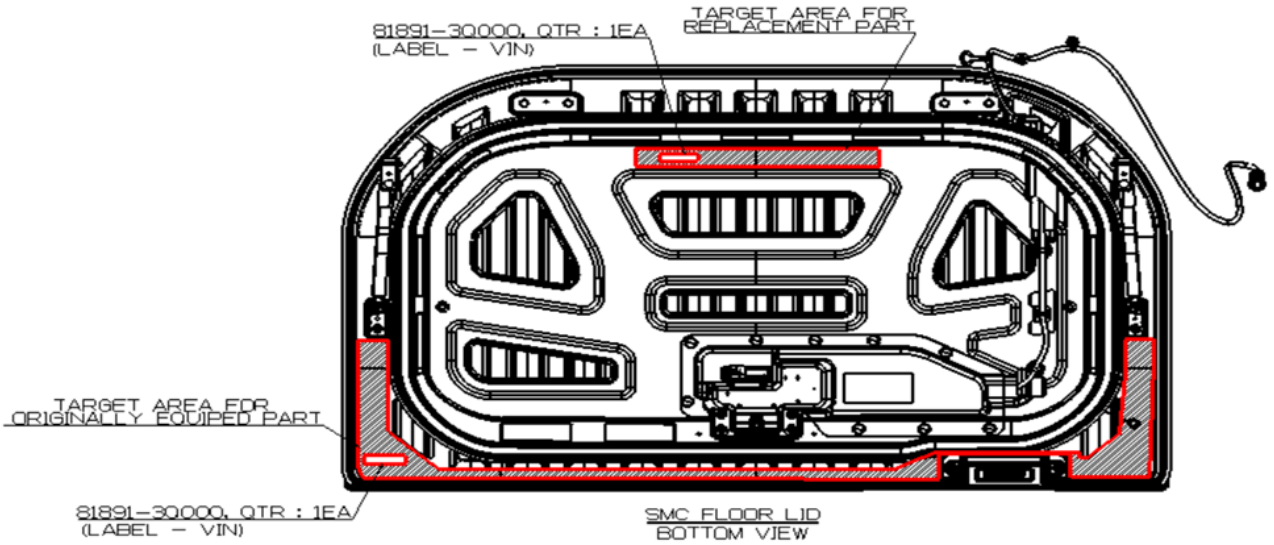

Pickup Box (Headboard)

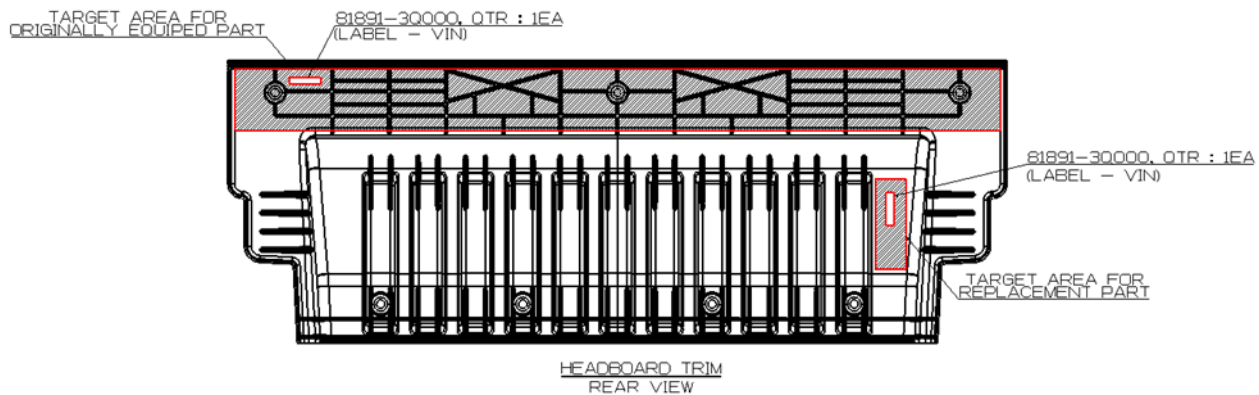

Pickup Box (Sidewall)

