

## **VIN marking area for Tucson model**

1. Hood
2. Tail gate
3. Front Fender (LH/RH)
4. Front Door (LH/RH)
5. Rear Door (LH/RH)
6. Side Outer Panel (LH/RH)
7. Front Bumper
8. Rear Bumper
9. Engine
10. Transmission

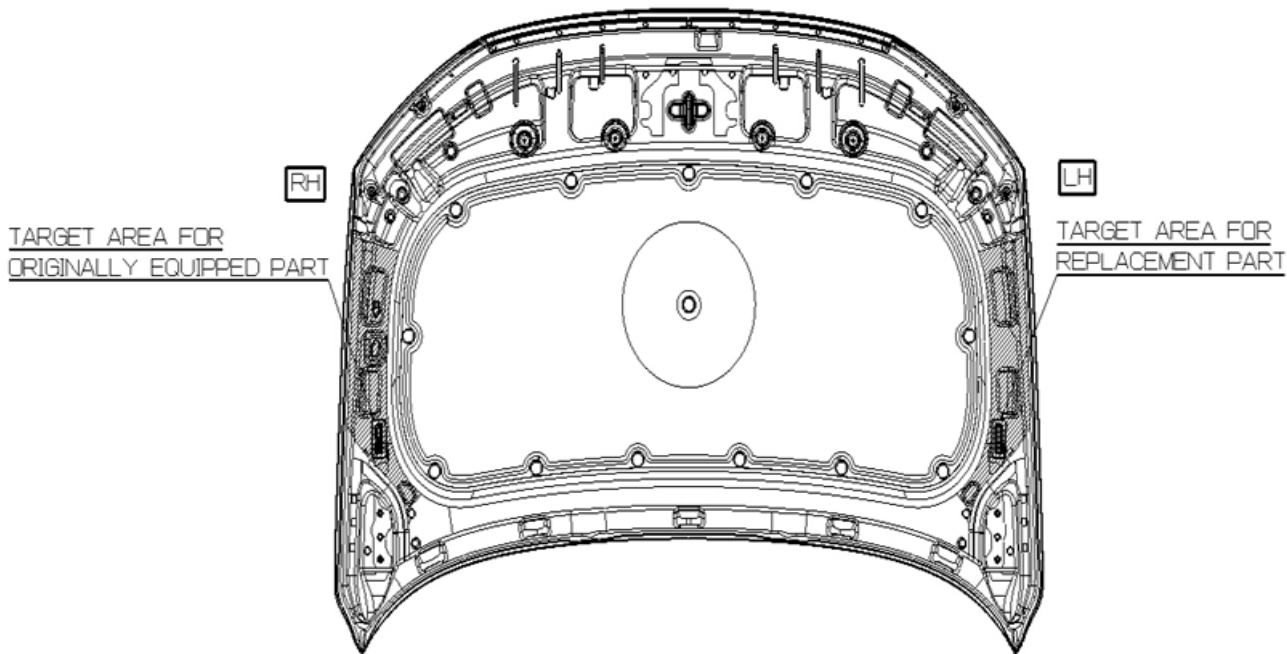

# Hood



# Tail Gate

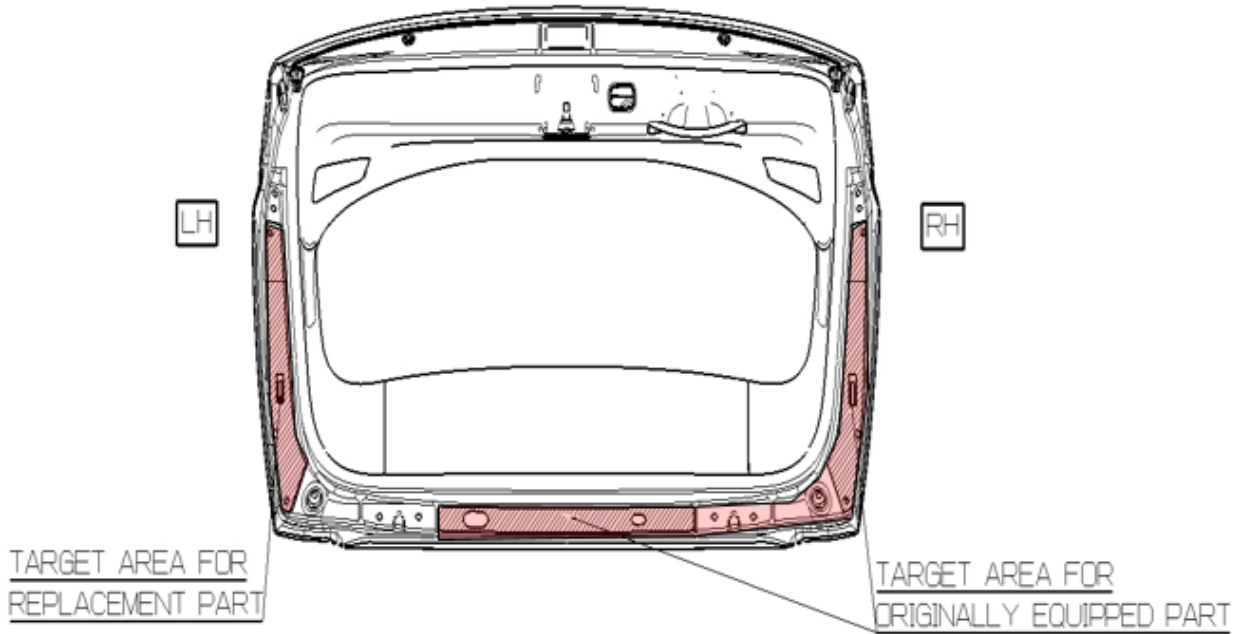

# Front Fender (LH/RH)

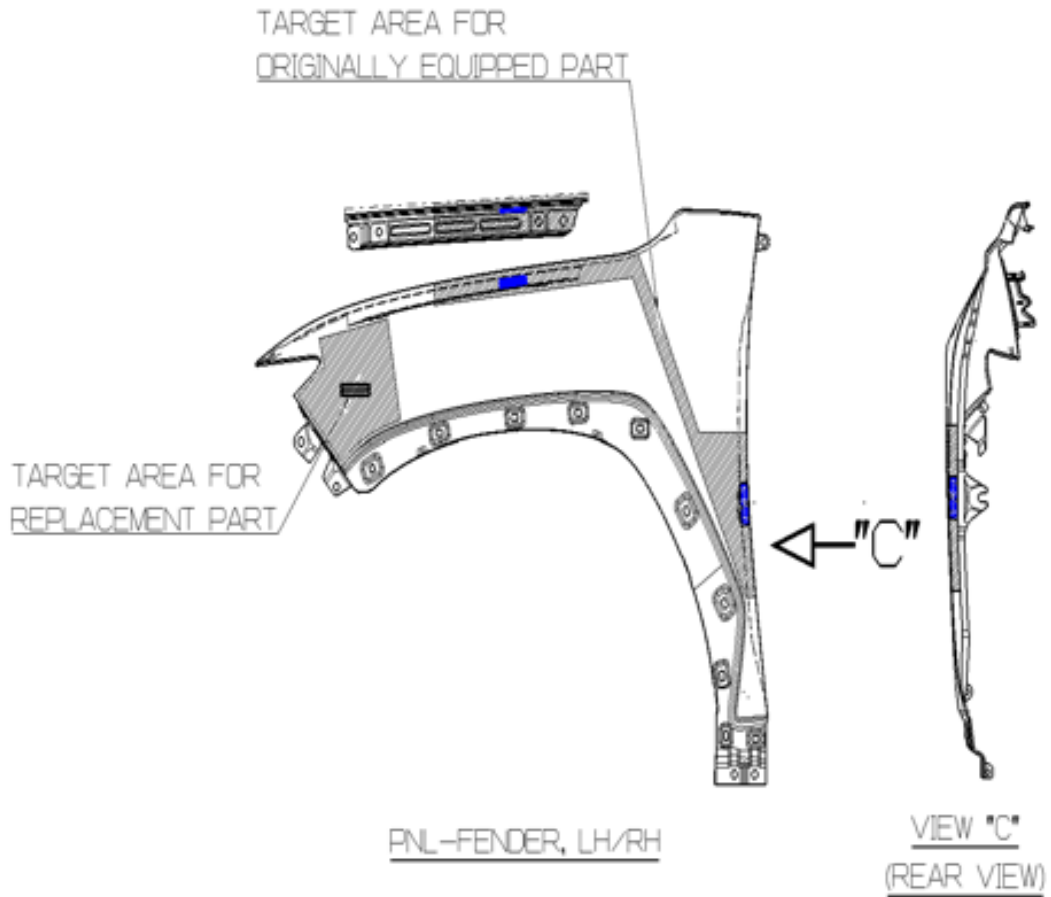

# Front Door (LH/RH)

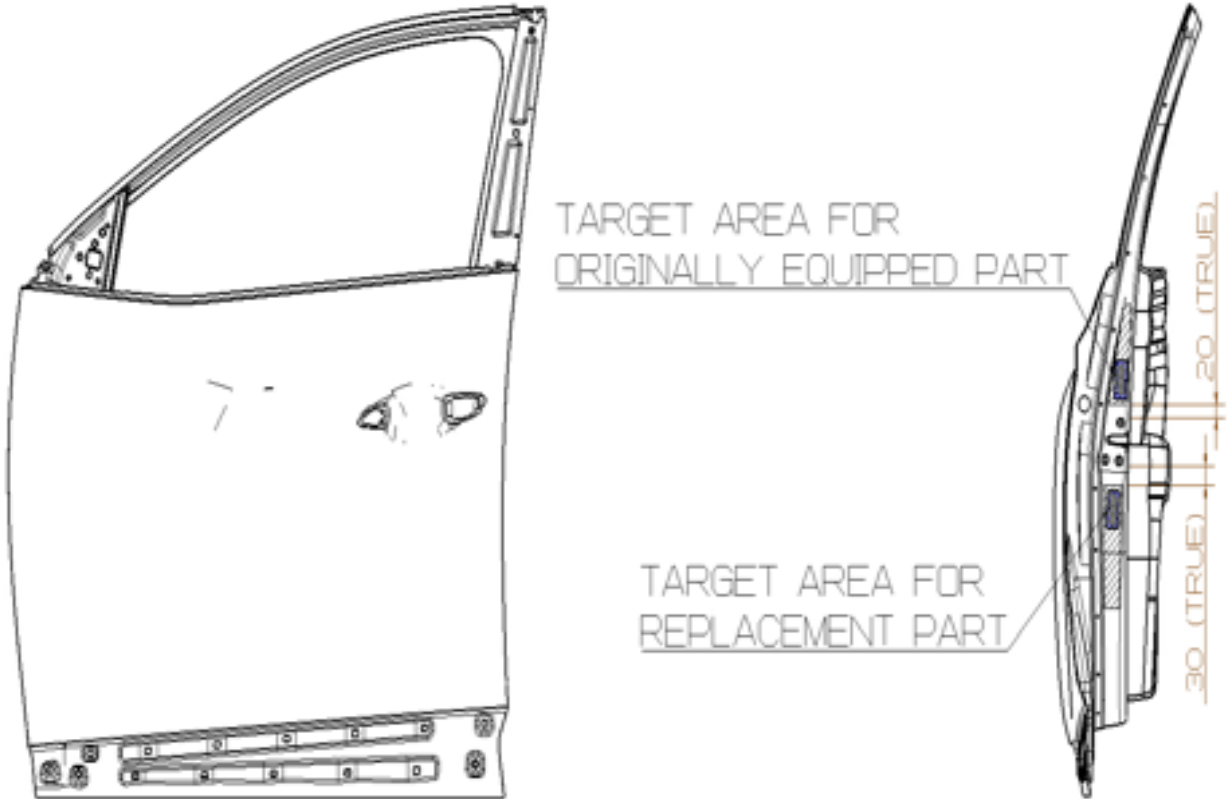

# Rear Door (LH/RH)

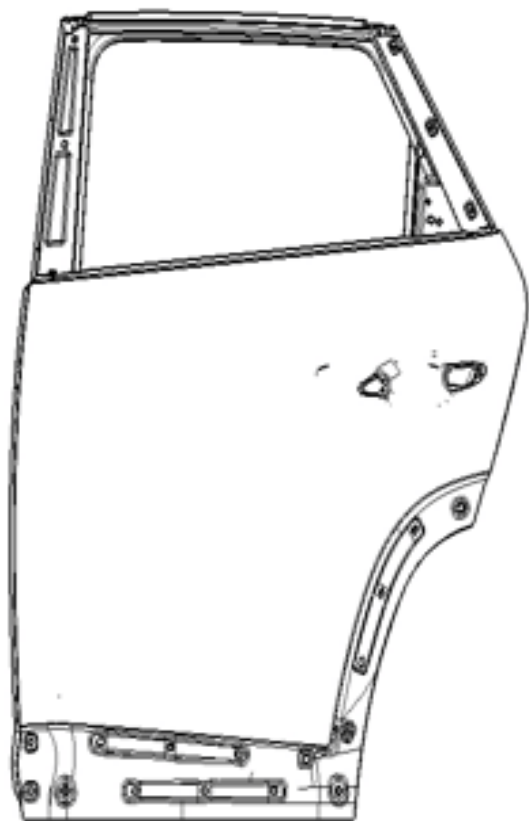

TARGET AREA FOR  
ORIGINALLY EQUIPPED PART

TARGET AREA FOR  
REPLACEMENT PART

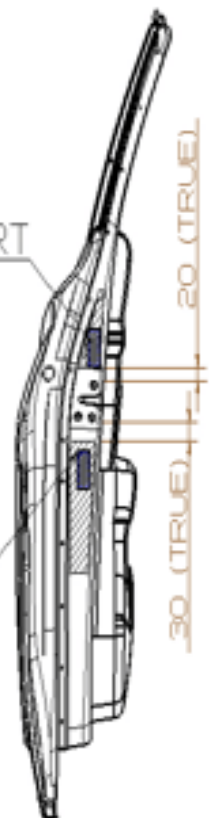

# Side Outer Panel (LH/RH)

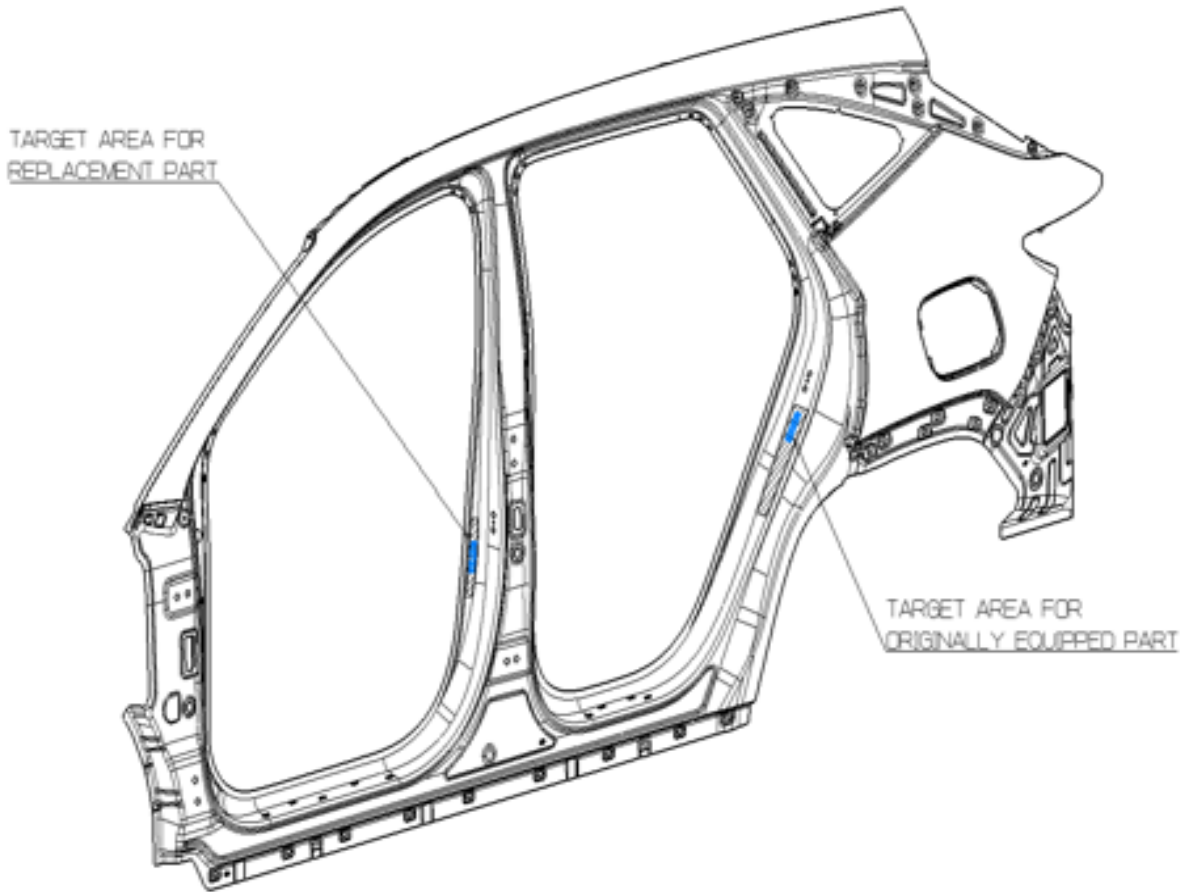

PNL-SIDE OTR, LH/RH

# Front Bumper

LABEL FOR ORIGINALLY EQUIPPED PART (RH, OUTSIDE)

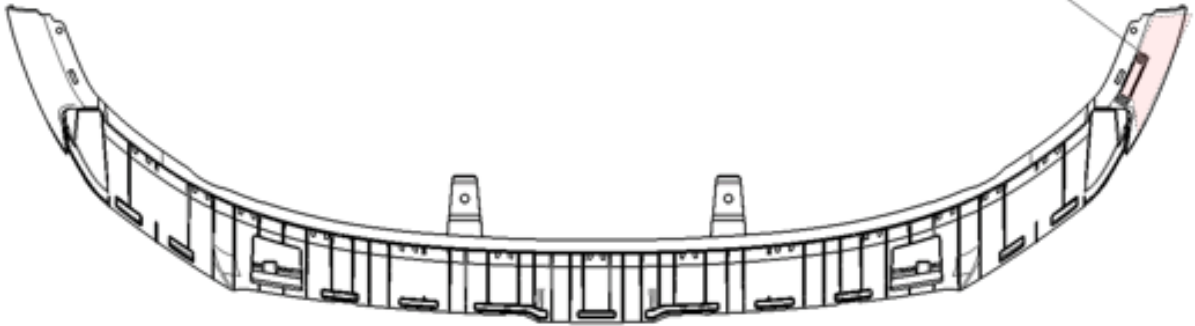

<FRONT BUMPER - BOTTOM VIEW>

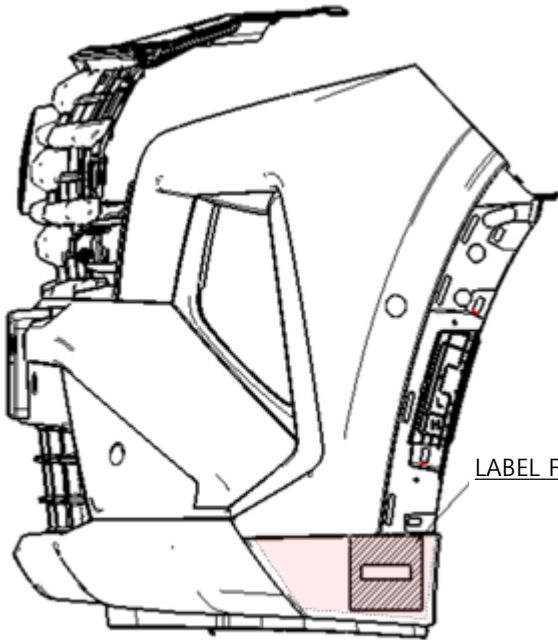

LABEL FOR REPLACEMENT PART (LH, INSIDE)

<FRONT BUMPER - SIDE VIEW>



## Rear Bumper

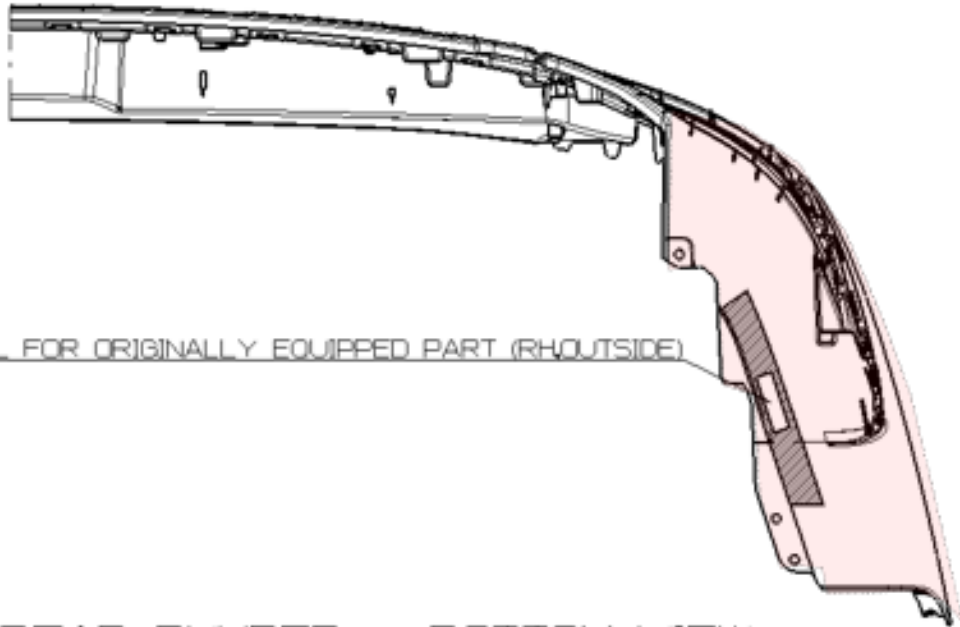

LABEL FOR ORIGINALLY EQUIPPED PART (RH, OUTSIDE)

<REAR BUMPER — BOTTOM VIEW>

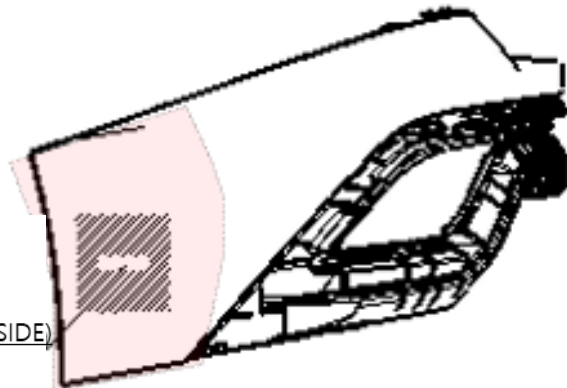

LABEL FOR REPLACEMENT PART (LH, INSIDE)

<REAR BUMPER — SIDE VIEW>

# Engine (Smartstream G 2.5)

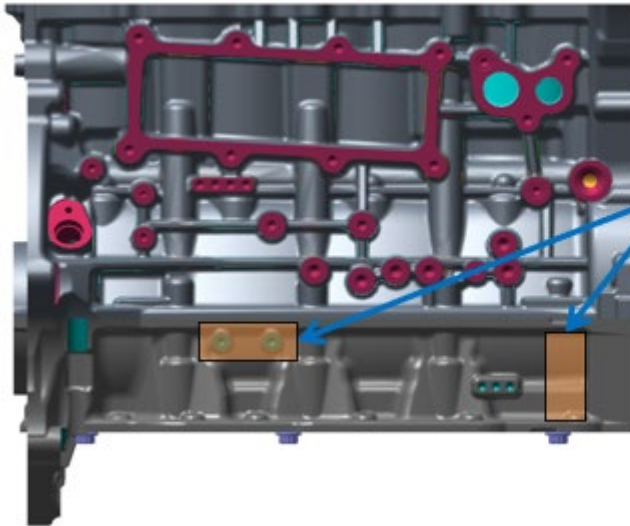

TARGET AREA FOR  
ORIGINALLY EQUIPPED PART  
(VIN PLATE)

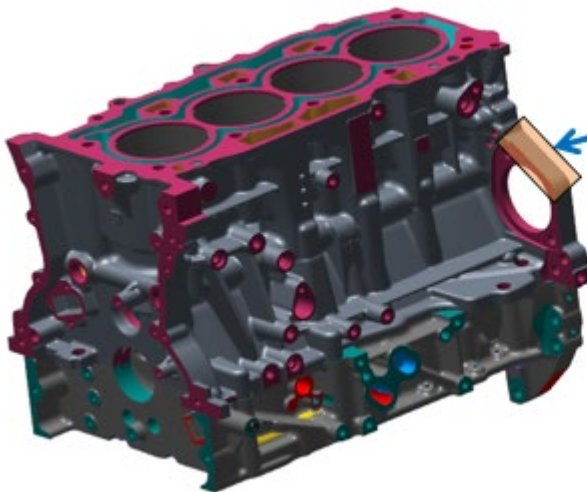

TARGET AREA FOR  
REPLACEMENT PART

# Transmission (8AT)

TARGET AREA FOR  
REPLACEMENT PART

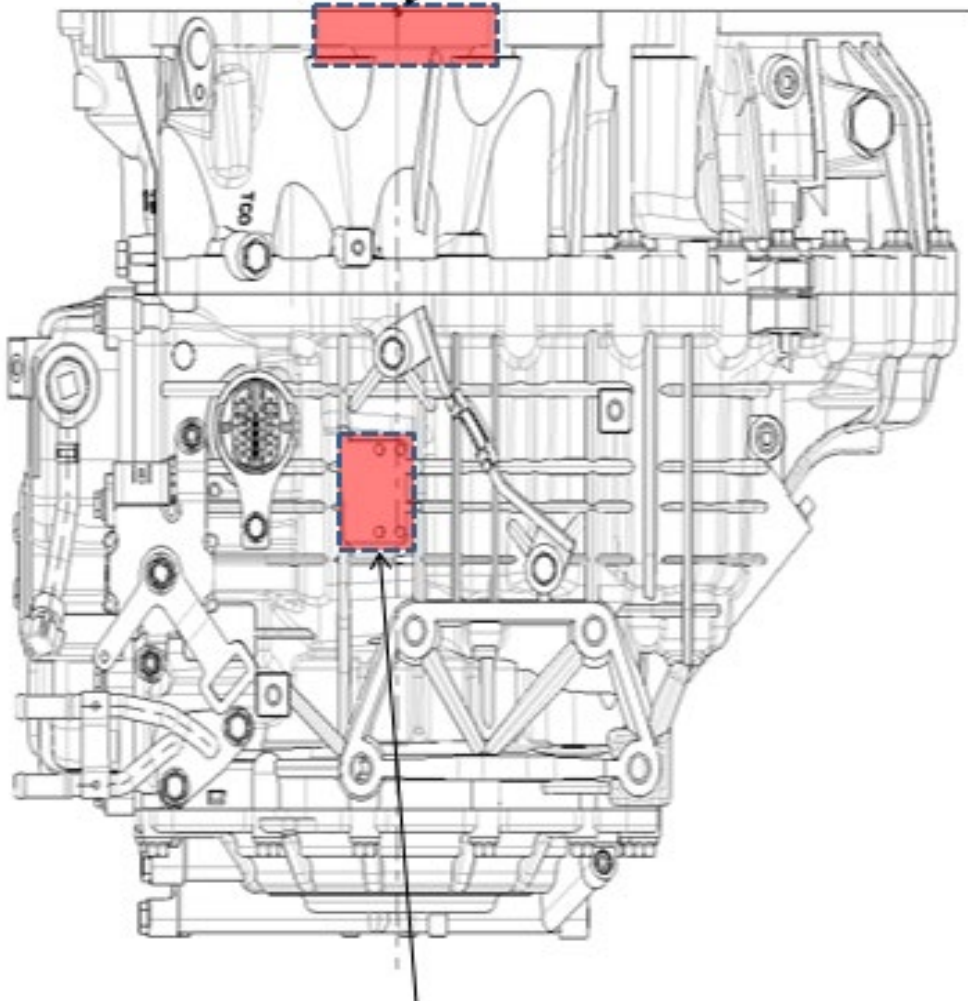

TARGET AREA FOR ORIGINALLY  
EQUIPPED PART