

VIN marking area for Tucson HEV model

- 1. Hood**
- 2. Tail gate**
- 3. Front Fender (LH/RH)**
- 4. Front Door (LH/RH)**
- 5. Rear Door (LH/RH)**
- 6. Side Outer Panel (LH/RH)**
- 7. Front Bumper**
- 8. Rear Bumper**
- 9. Engine [G1.6 DOHC T-GDI GAMMA II]**
- 10. Transmission [AT]**

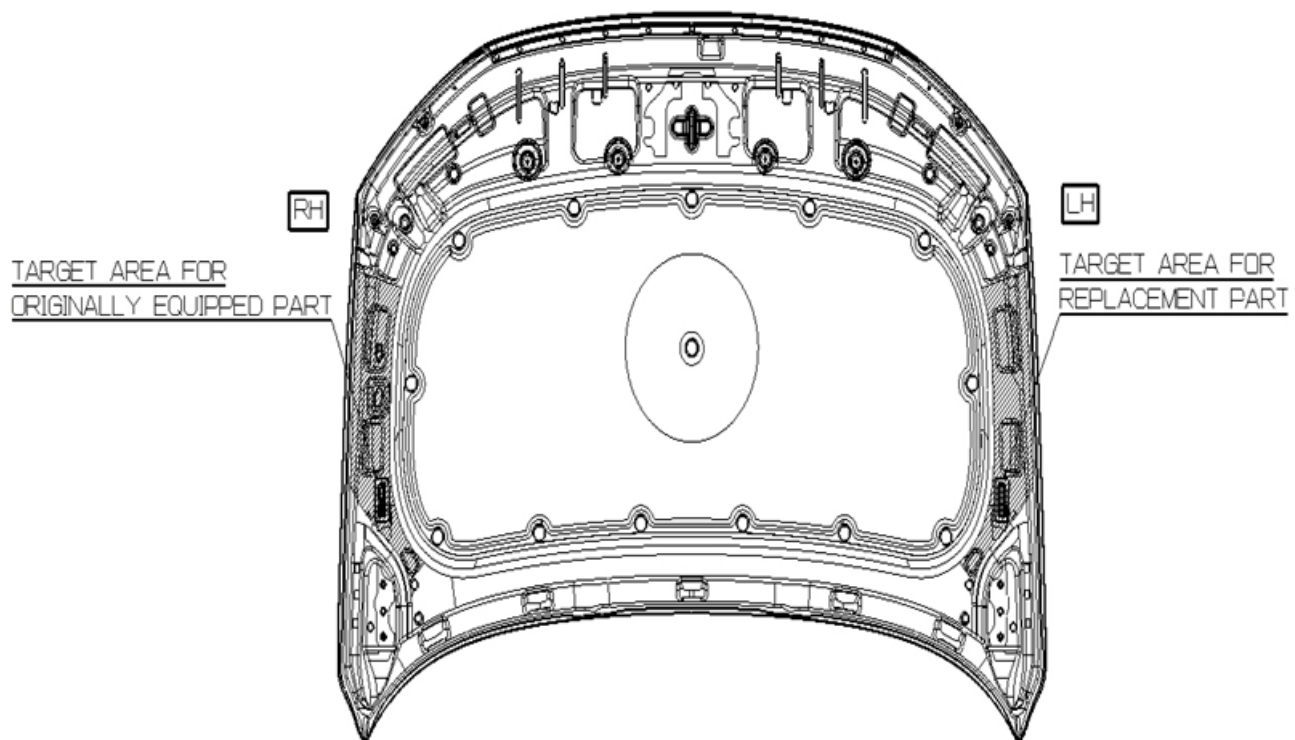

Hood



Tail Gate

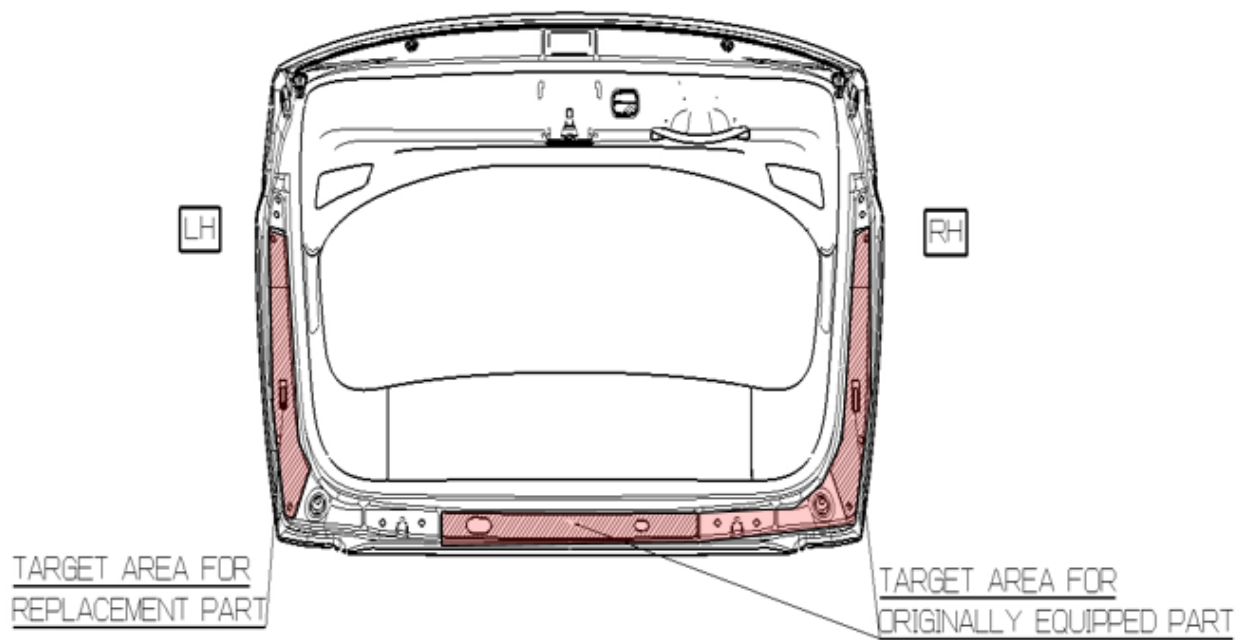

Front Fender (LH/RH)

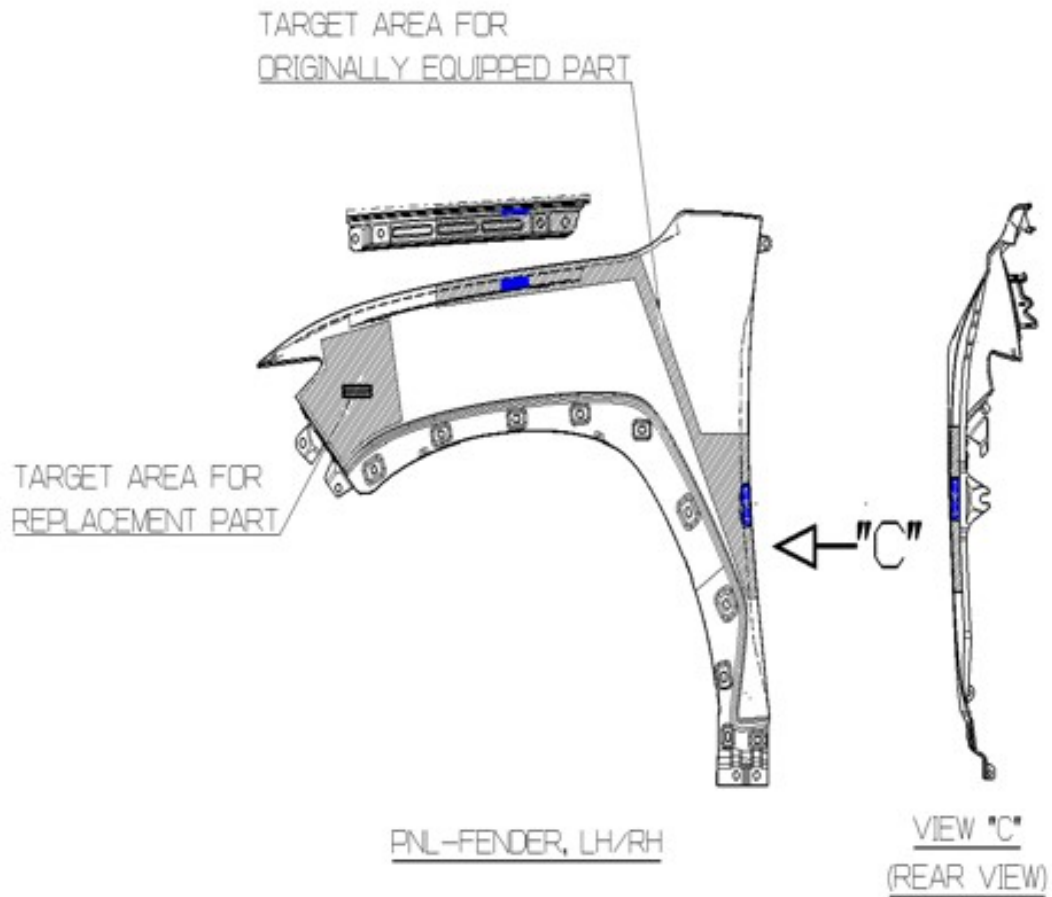

Front Door (LH/RH)



TARGET AREA FOR
ORIGINALLY EQUIPPED PART

TARGET AREA FOR
REPLACEMENT PART

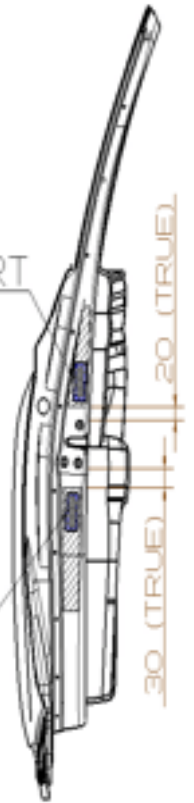

Rear Door (LH/RH)

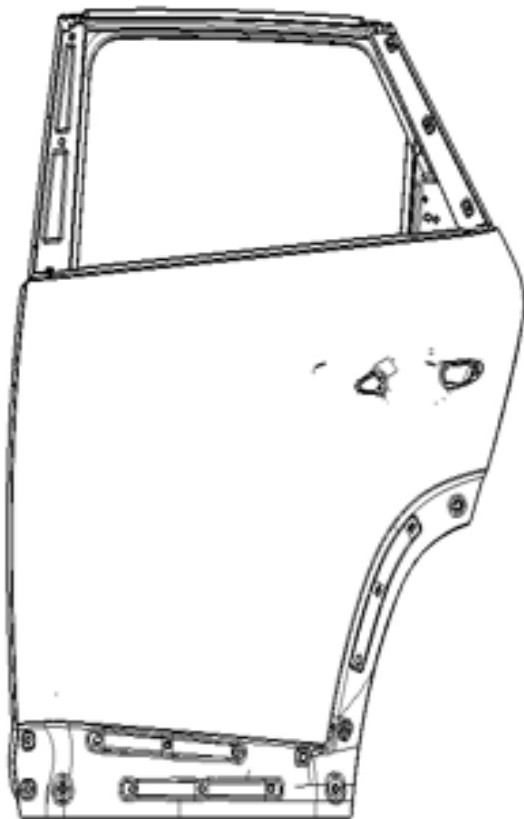

TARGET AREA FOR
ORIGINALLY EQUIPPED PART

TARGET AREA FOR
REPLACEMENT PART

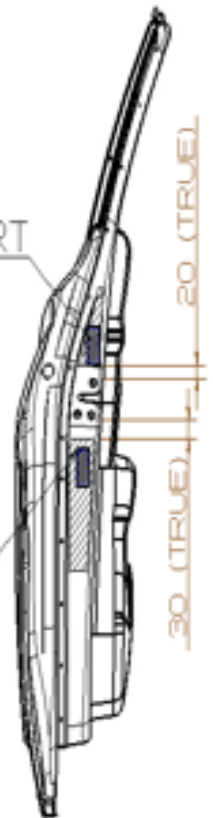

Side Outer Panel (LH/RH)

TARGET AREA FOR
REPLACEMENT PART

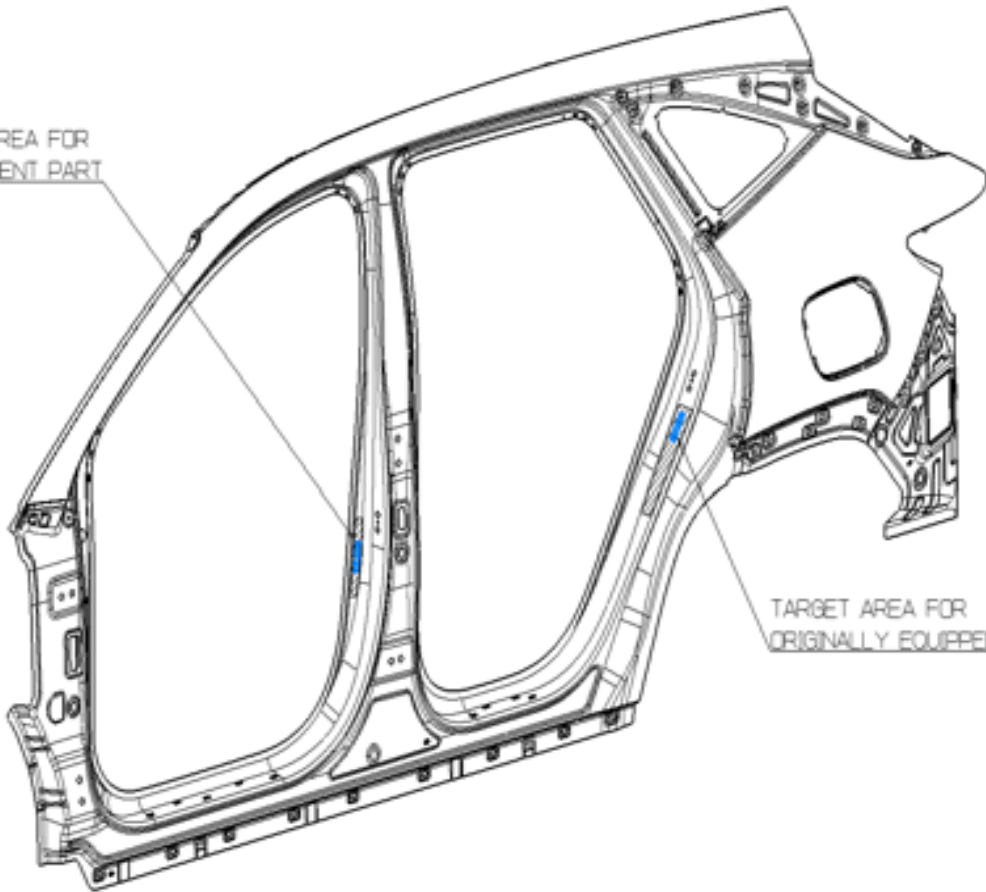

TARGET AREA FOR
ORIGINALLY EQUIPPED PART

PNL-SIDE OTR, LH/RH

Front Bumper

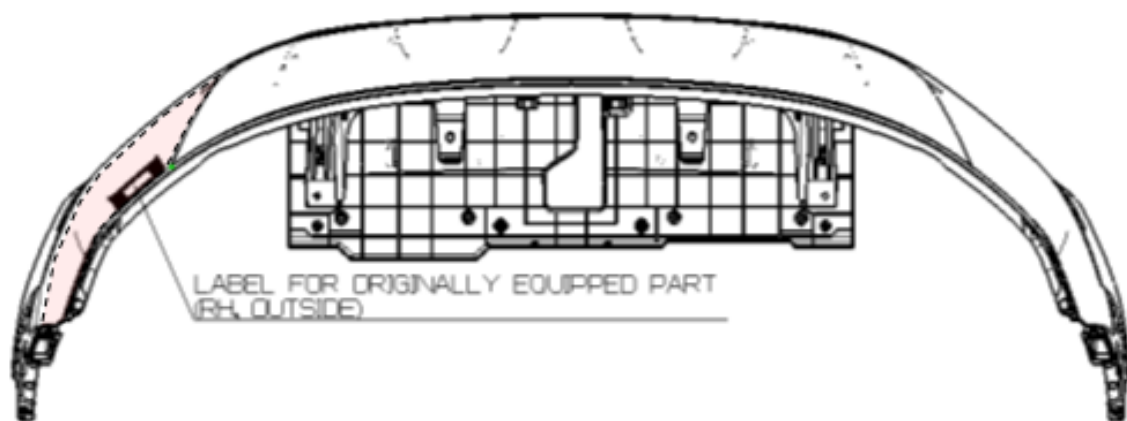

< FRONT BUMPER - BOTTOM VIEW >

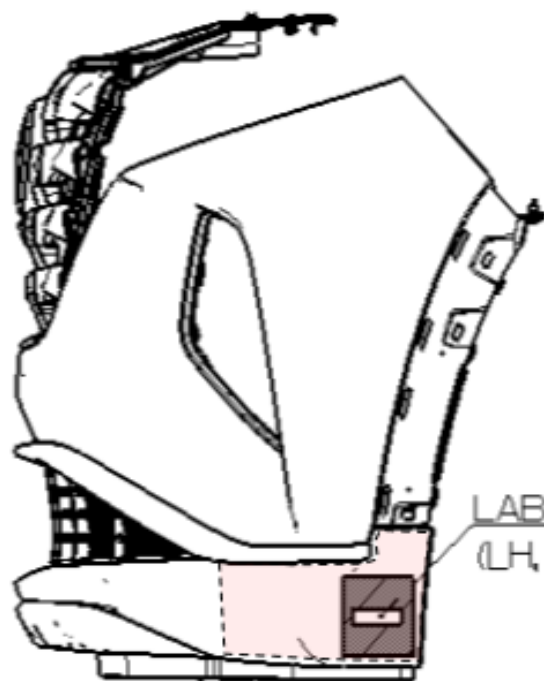

< FRONT BUMPER - SIDE VIEW >

Rear Bumper

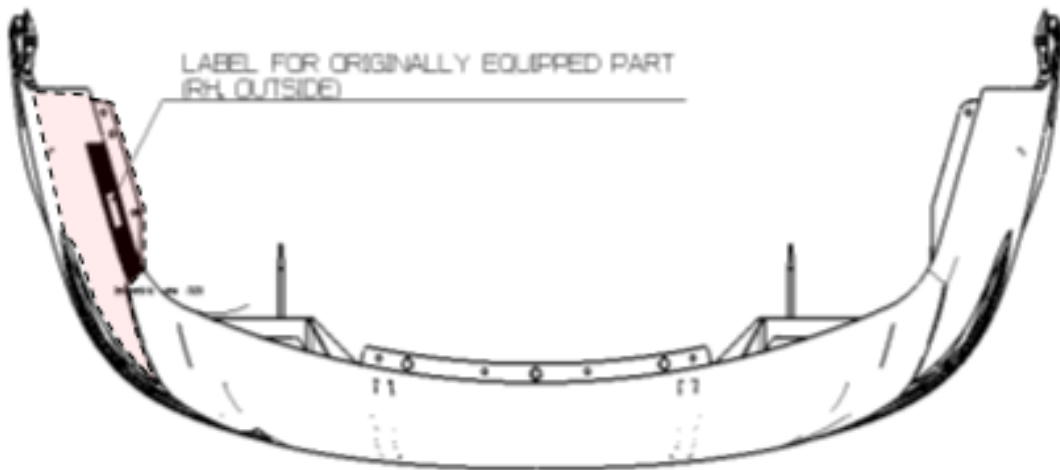

< REAR BUMPER - BOTTOM VIEW >

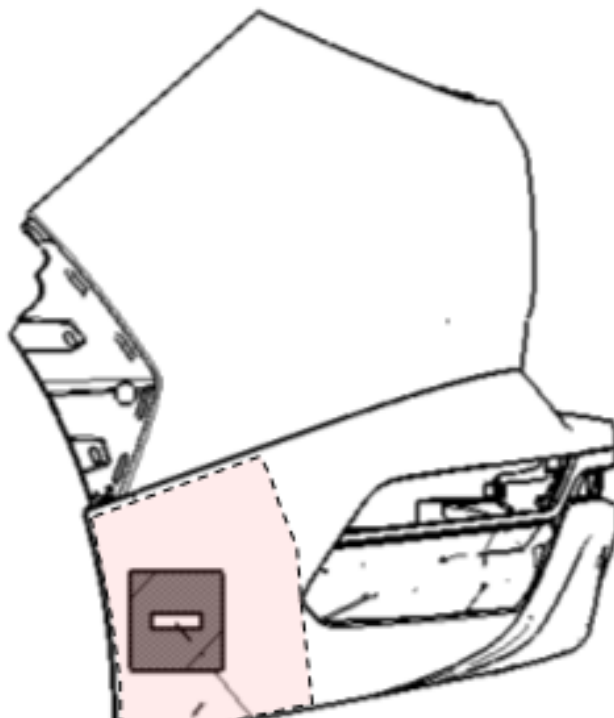

LABEL FOR REPLACEMENT PART
(LH, INSIDE)

< REAR BUMPER - SIDE VIEW >

Engine (1.6 T-GDI HEV)

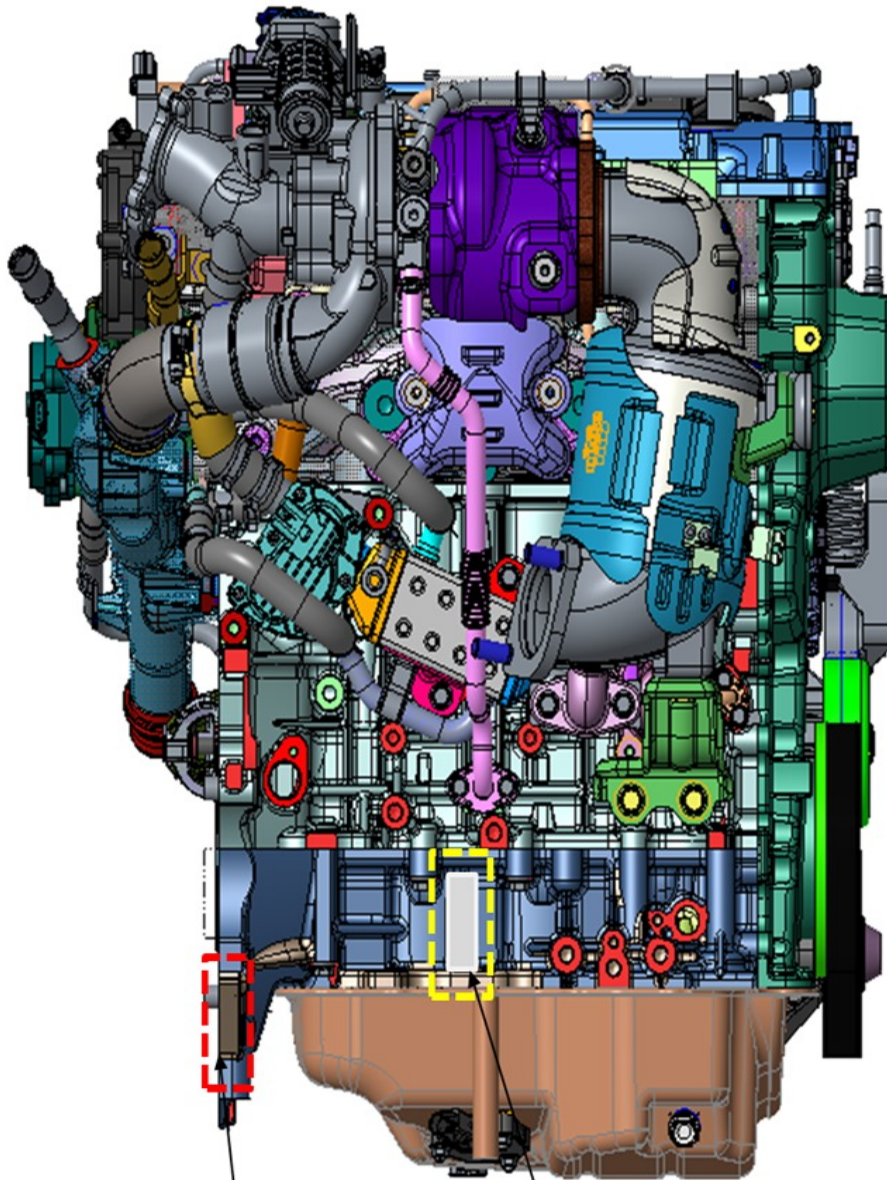

**TARGET AREA FOR
REPLACEMENT PART**

**TARGET AREA FOR
ORIGINALLY EQUIPPED PART**

Transmission (HEV Auto for 1.6T HEV 2/4WD)

TARGET AREA FOR
REPLACEMENT PART

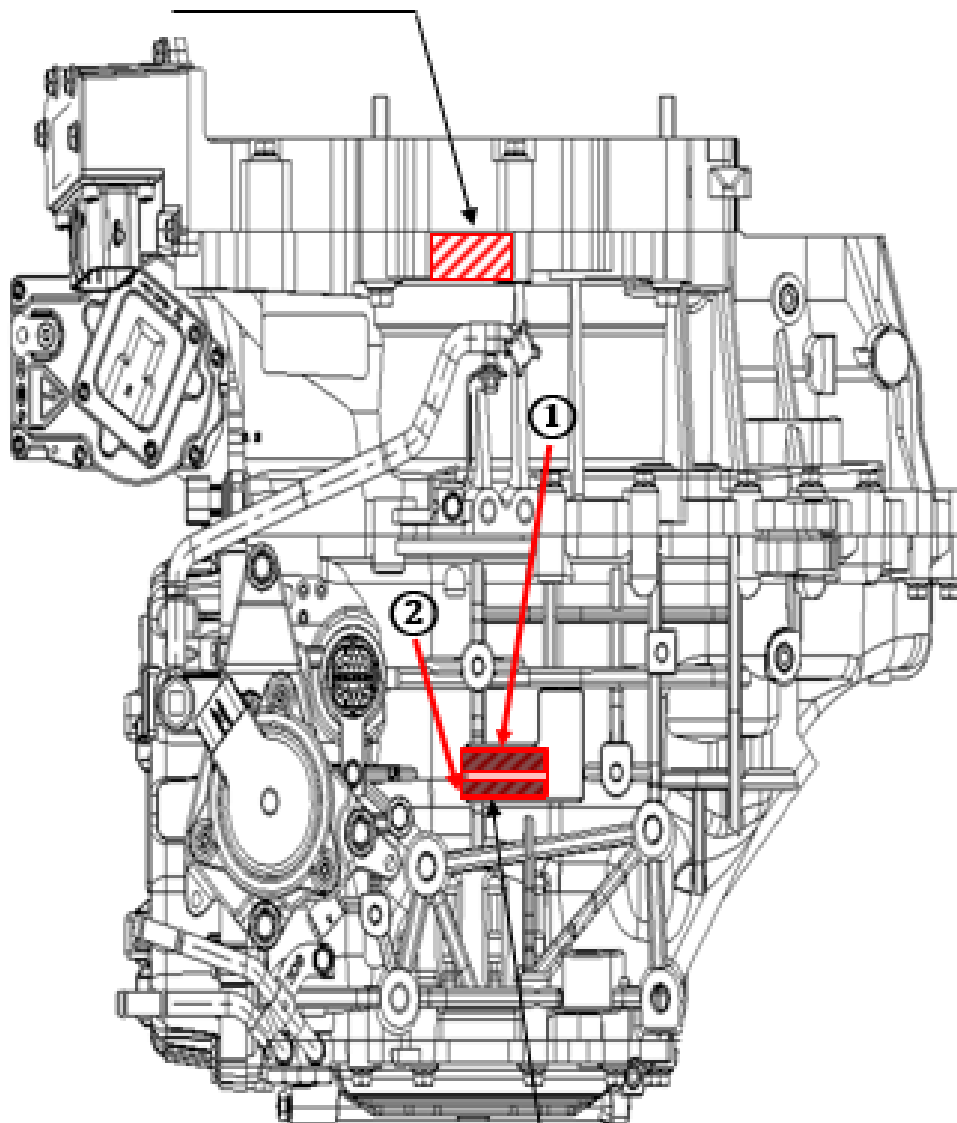

TARGET AREA FOR
ORIGINALLY EQUIPPED
PART