

VIN marking area for Sportage PHEV model

1. Hood
2. Tail gate
3. Front Fender (LH/RH)
4. Front Door (LH/RH)
5. Rear Door (LH/RH)
6. Side Outer Panel (LH/RH)
7. Front Bumper
8. Rear Bumper
9. Engine
10. Transmission [AT]

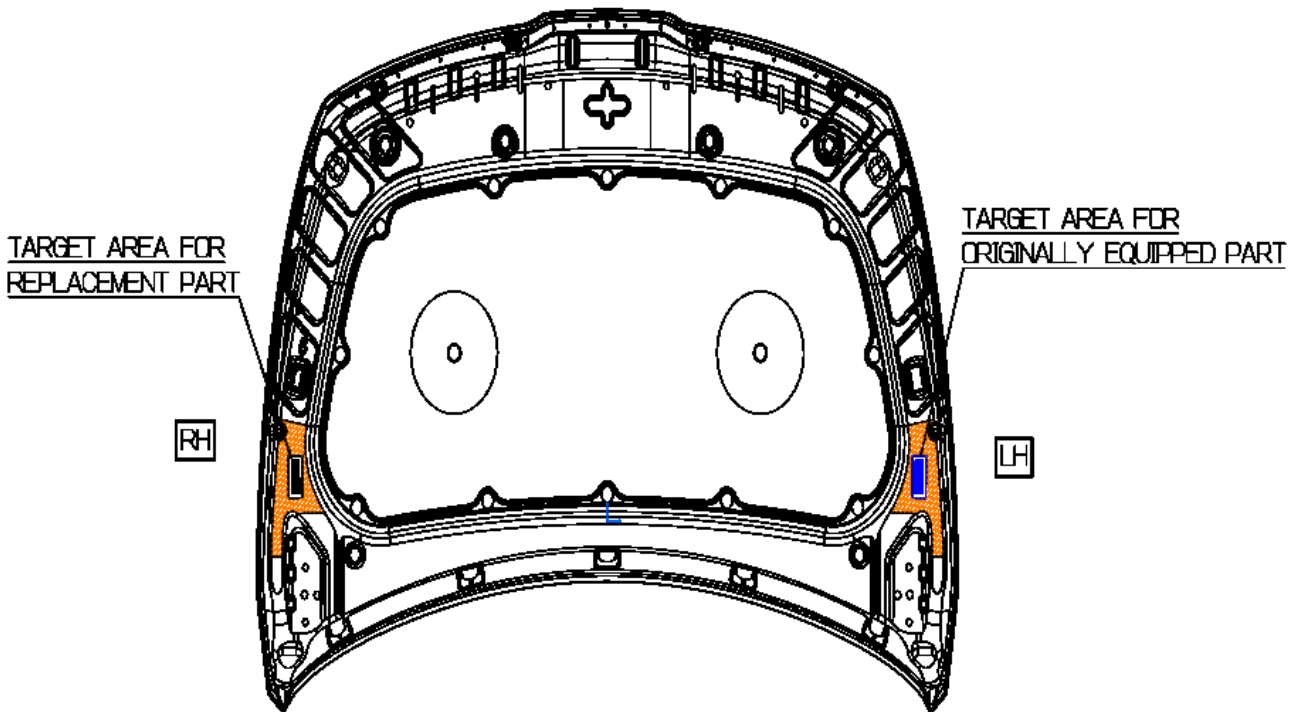

Hood



Tail Gate

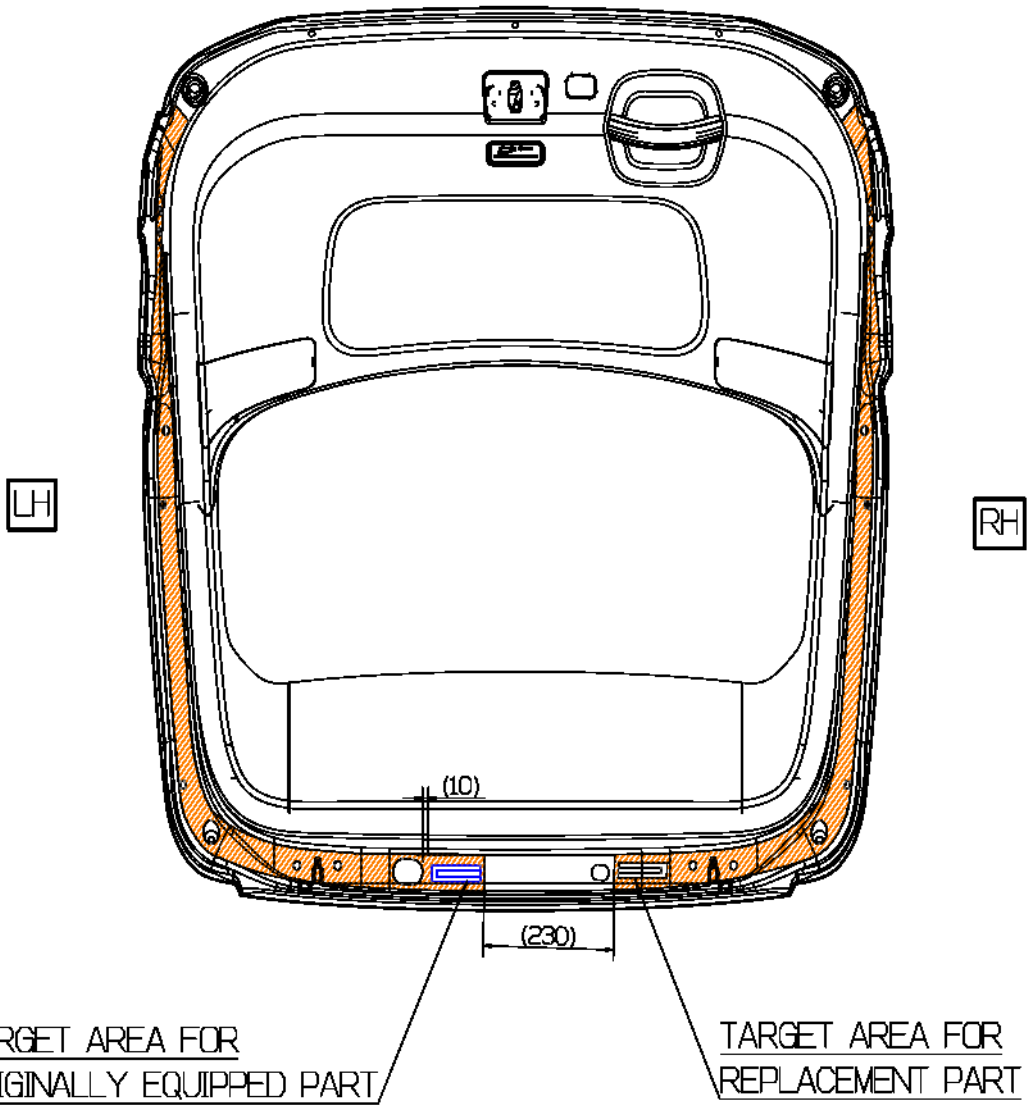

Front Fender (LH/RH)

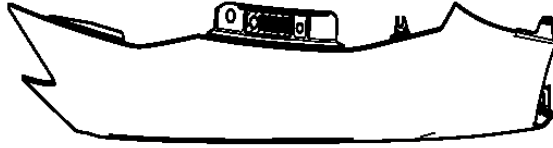

VIEW "C"
(TOP VIEW)

TARGET AREA FOR
ORIGINALLY EQUIPPED PART

"C"

TARGET AREA FOR
REPLACEMENT PART

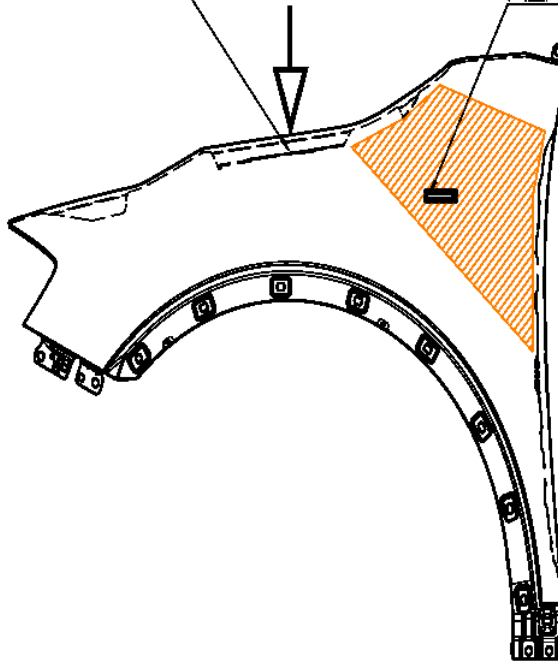

PNL-FENDER, LH/RH

Front Door (LH/RH)

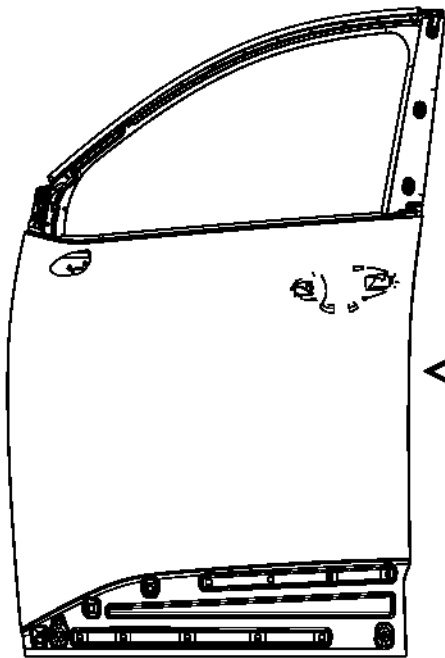

← "A"

TARGET AREA FOR
ORIGINALLY EQUIPPED PART

TARGET AREA FOR
REPLACEMENT PART

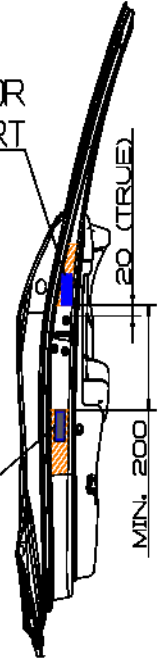

PNL ASSY-FR DR, LH/RH

VIEW "A"

Rear Door (LH/RH)

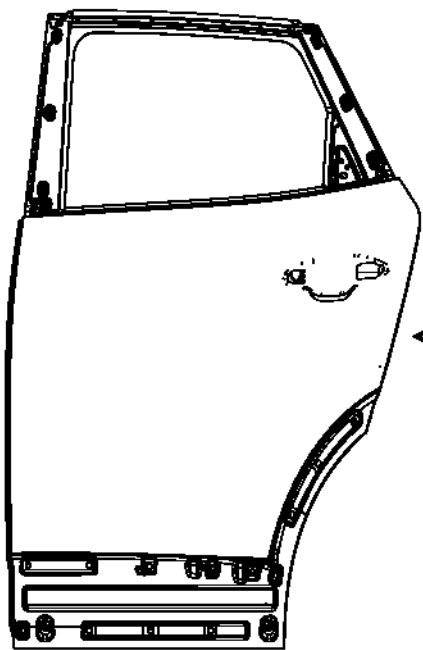

← "B"

TARGET AREA FOR
ORIGINALLY EQUIPPED PART

TARGET AREA FOR
REPLACEMENT PART

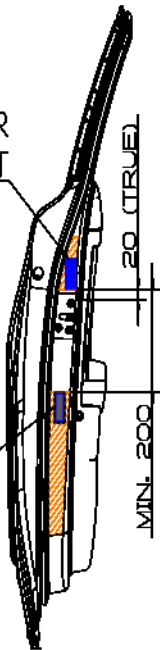

PNL ASSY-RR DR, LH/RH

VIEW "B"

Side Outer Panel (LH/RH)

TARGET AREA FOR
ORIGINALLY EQUIPPED PART (FOR NOS)

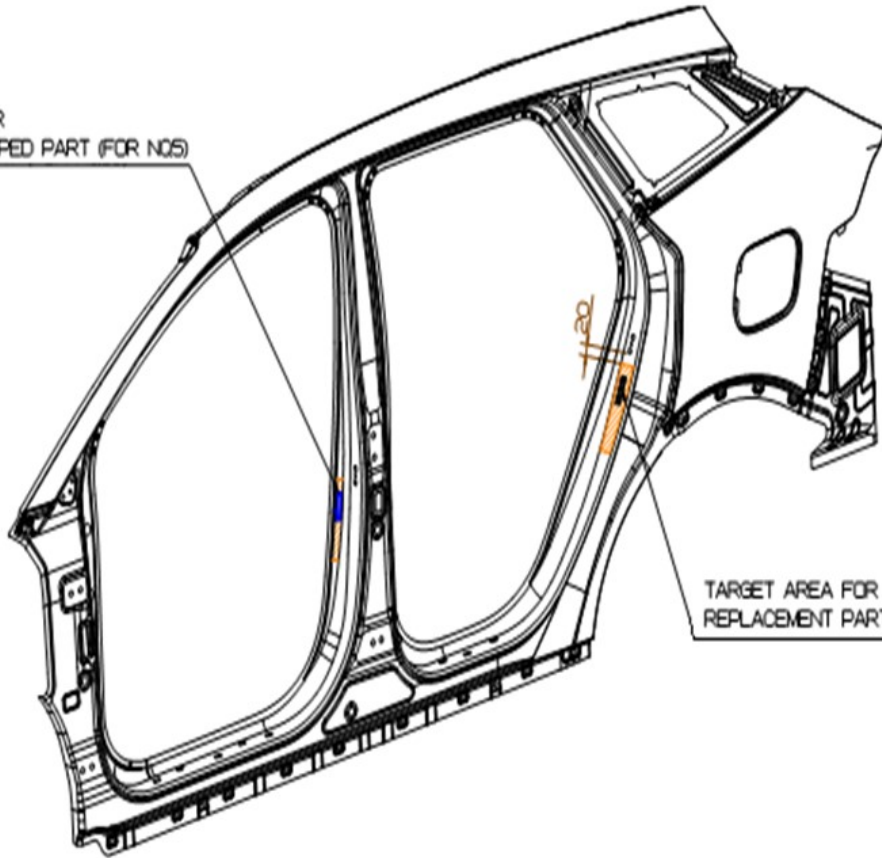

TARGET AREA FOR
REPLACEMENT PART (FOR NOS)

PNL-SIDE OTR, LH/RH

Front Bumper

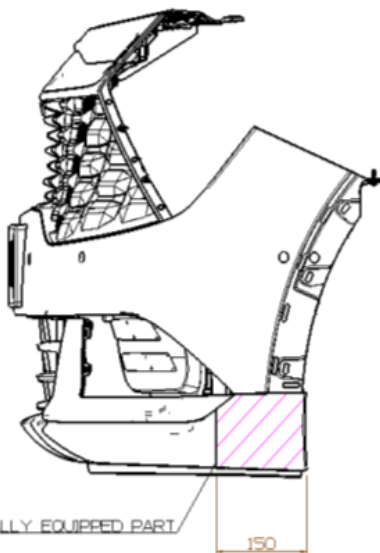

LABEL FOR ORIGINALLY EQUIPPED PART
(LH, INSIDE)

LABEL FOR REPLACEMENT PART
(RH, INSIDE)

(LABEL-VIN : 86465-R0300, 1EA)

FR BUMPER ASSY (STD)

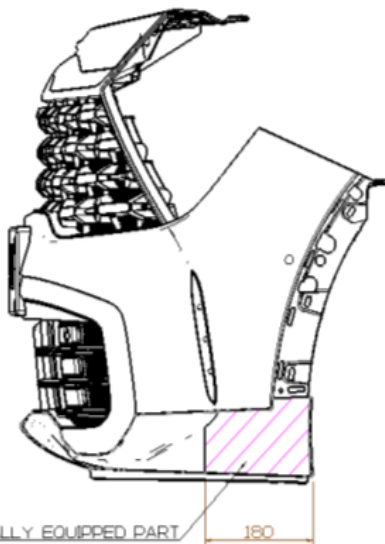

LABEL FOR ORIGINALLY EQUIPPED PART
(LH, INSIDE)

LABEL FOR REPLACEMENT PART
(RH, INSIDE)

(LABEL-VIN : 86465-R0300, 1EA)

FR BUMPER ASSY (X-LINE)

Rear Bumper

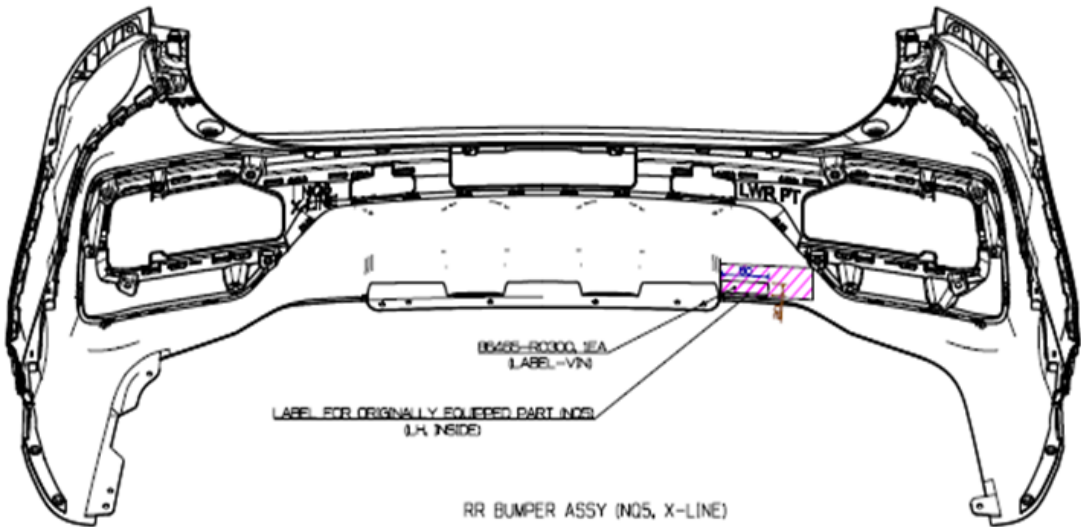
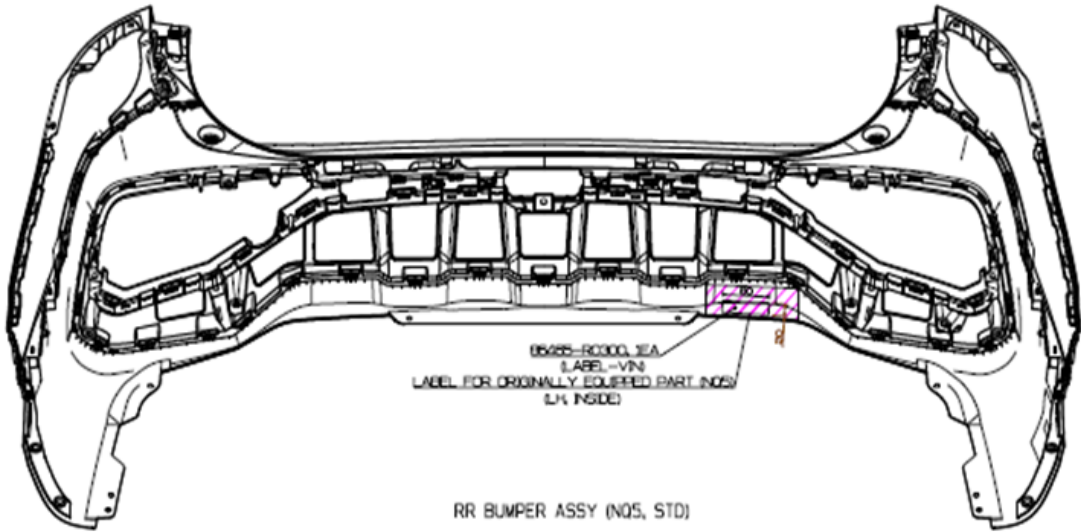

Rear Bumper

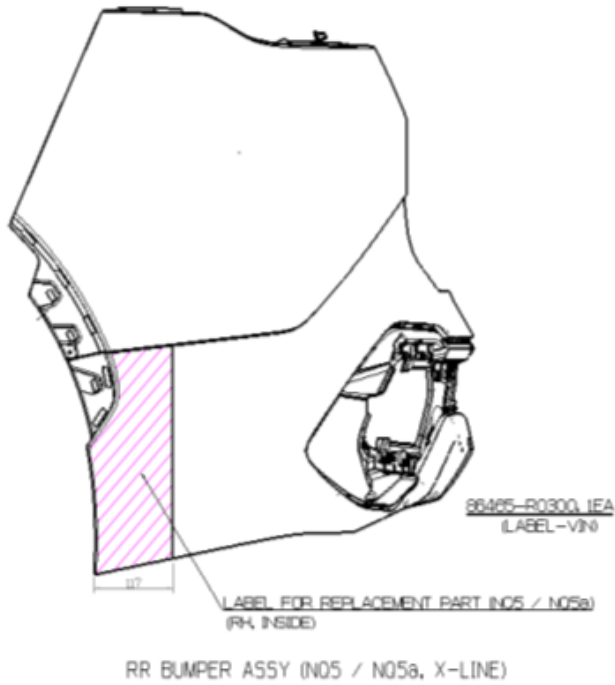
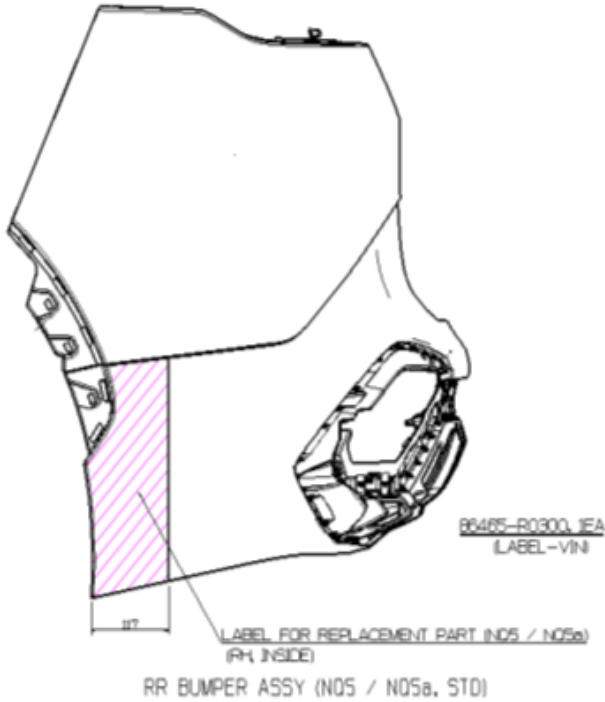

Engine (1.6 T-GDI PHEV)

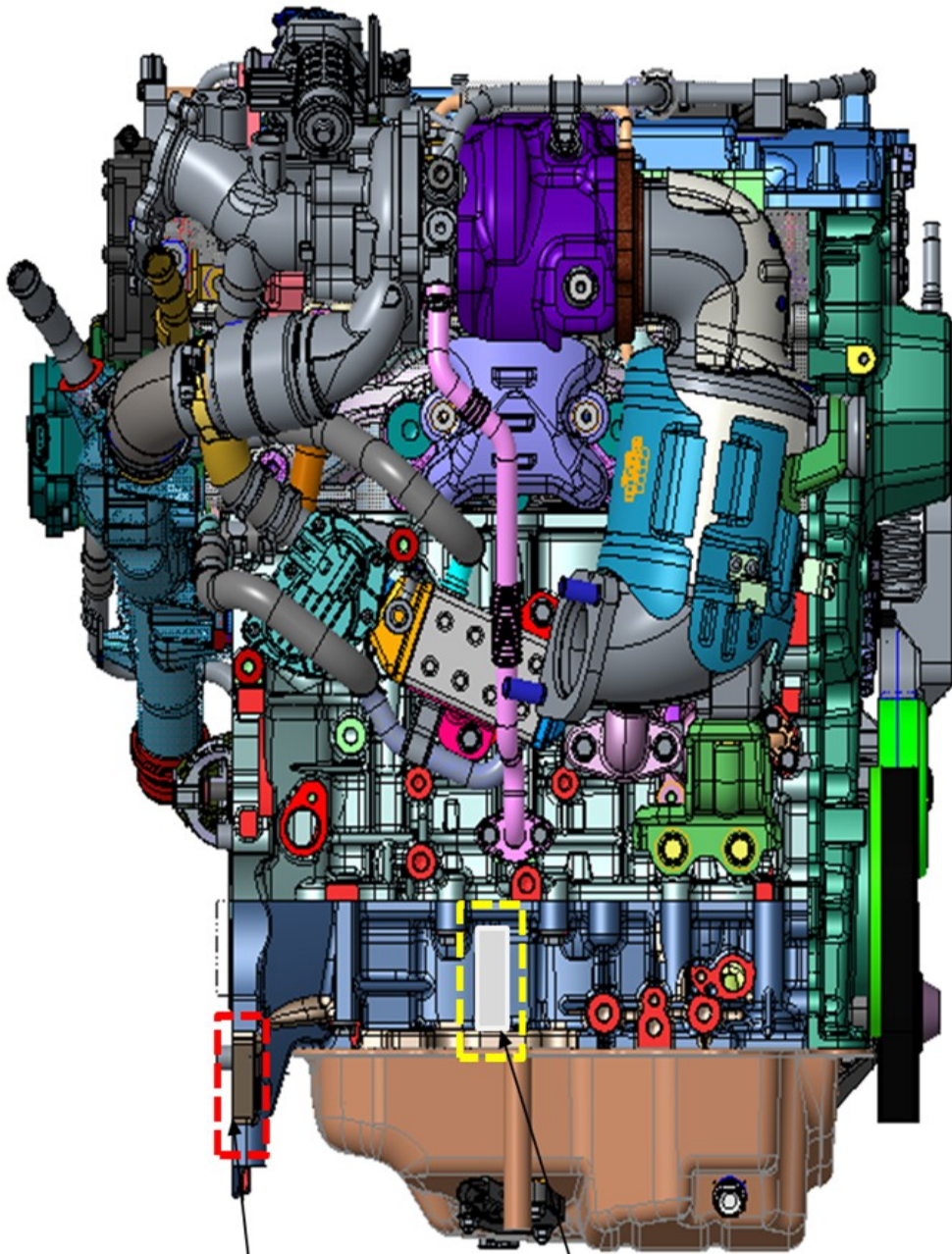

**TARGET AREA FOR
REPLACEMENT PART**

**TARGET AREA FOR
ORIGINALLY EQUIPPED PART**

Transmission (Automatic, 2WD/4WD)

**TARGET AREA FOR
REPLACEMENT PART**

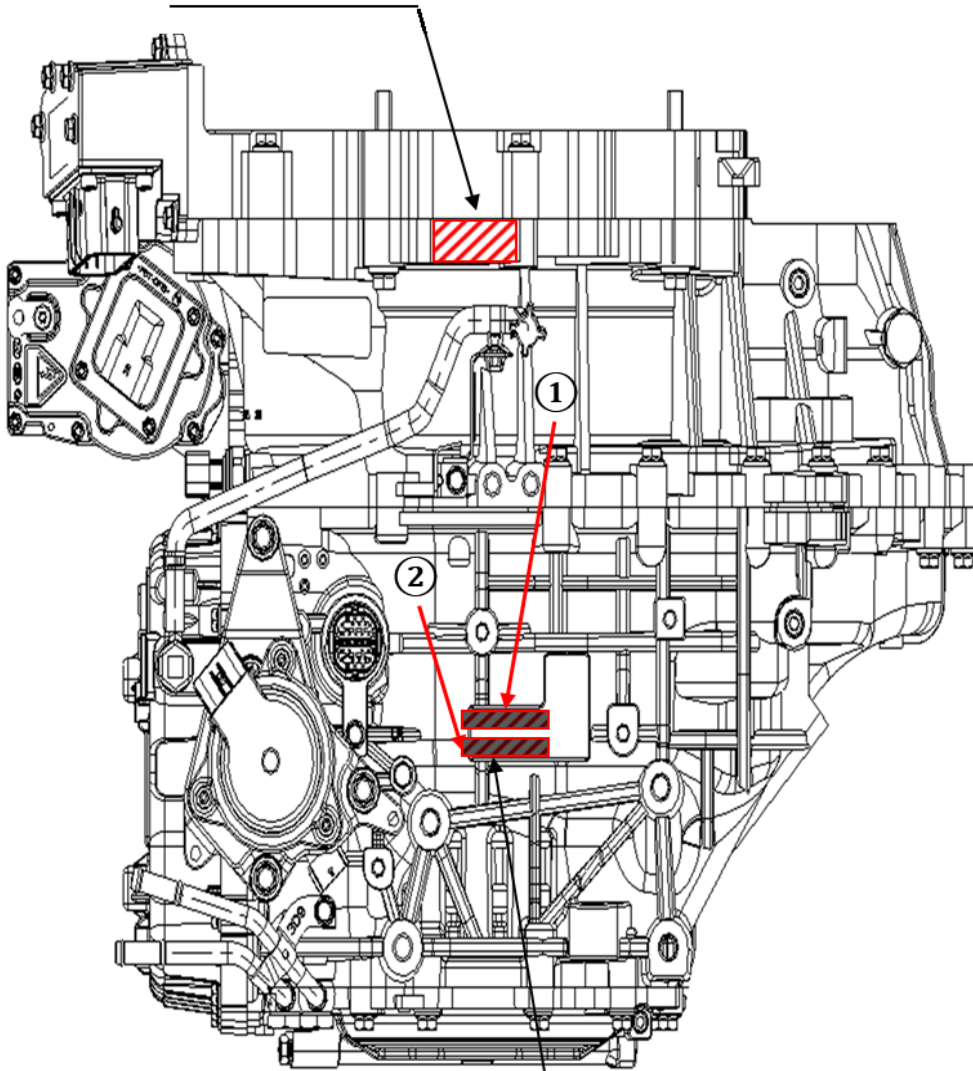

**TARGET AREA FOR
ORIGINALLY EQUIPPED
PART**

**※ VIN plate for originally equipped part
will be attached to either ① or ②.**