

VIN marking area for Sportage model

- 1. Hood**
- 2. Tail gate**
- 3. Front Fender (LH/RH)**
- 4. Front Door (LH/RH)**
- 5. Rear Door (LH/RH)**
- 6. Side Outer Panel (LH/RH)**
- 7. Front Bumper**
- 8. Rear Bumper**
- 9. Engine**
- 10. Transmission [AT]**

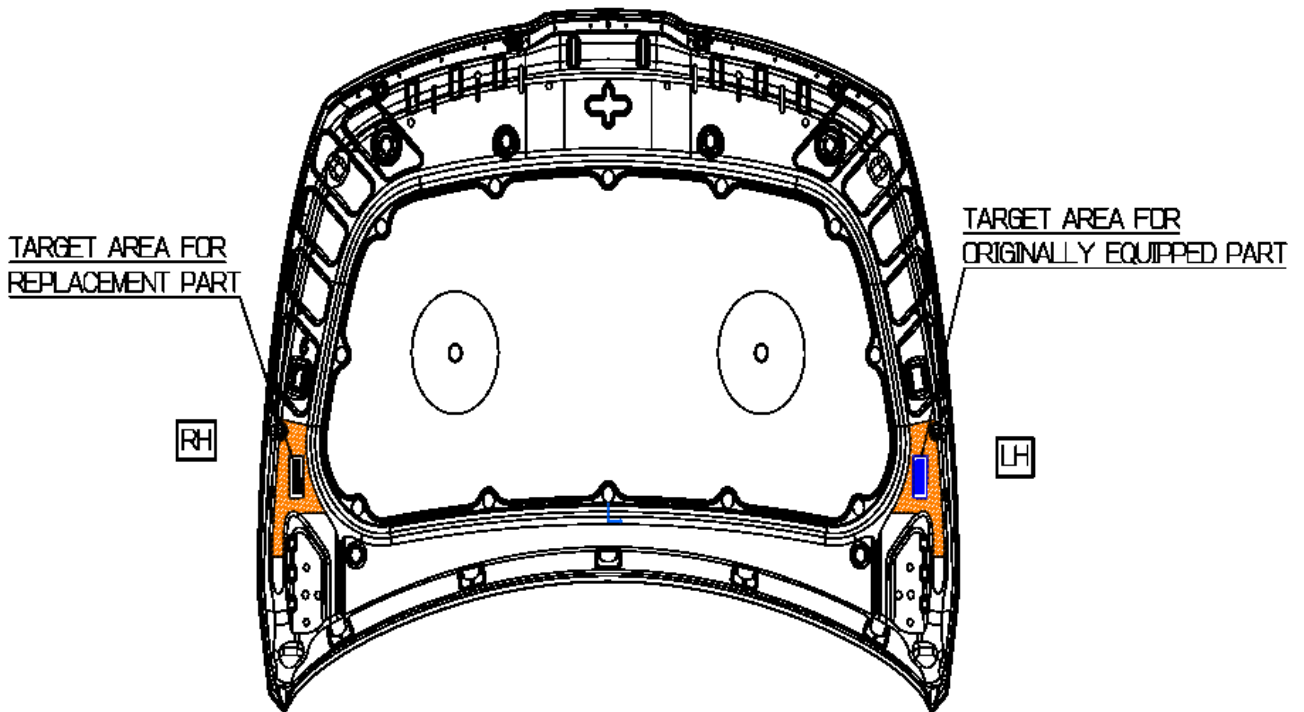

Hood



Tail Gate

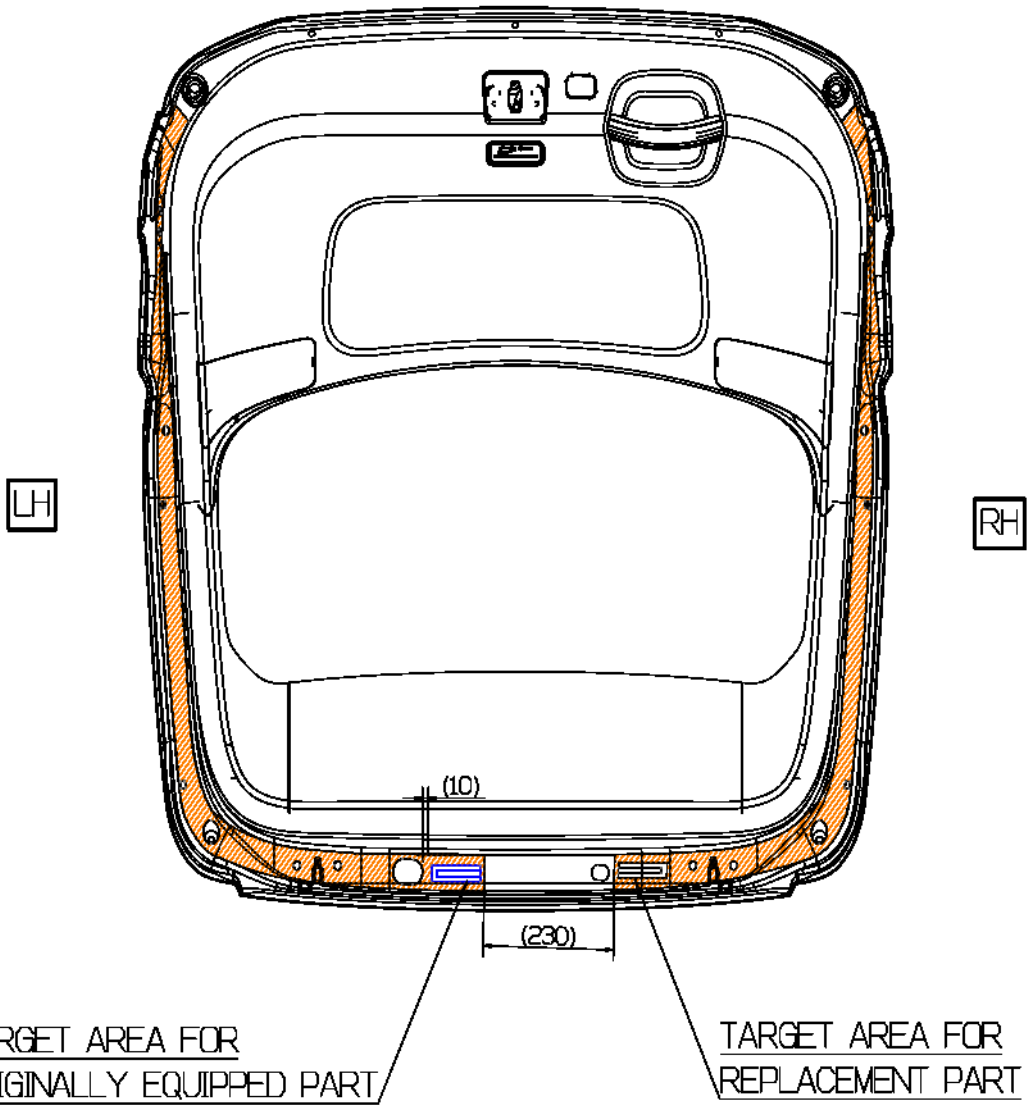

Front Fender (LH/RH)

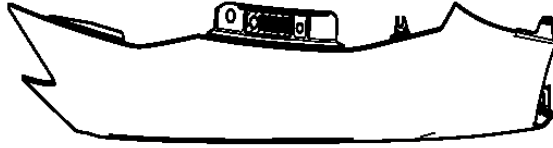

VIEW "C"
(TOP VIEW)

TARGET AREA FOR
ORIGINALLY EQUIPPED PART

"C"

TARGET AREA FOR
REPLACEMENT PART

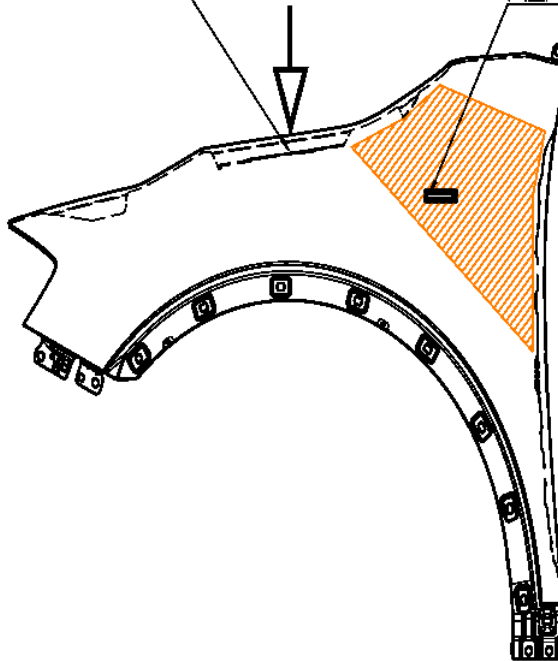

PNL-FENDER, LH/RH

Front Door (LH/RH)

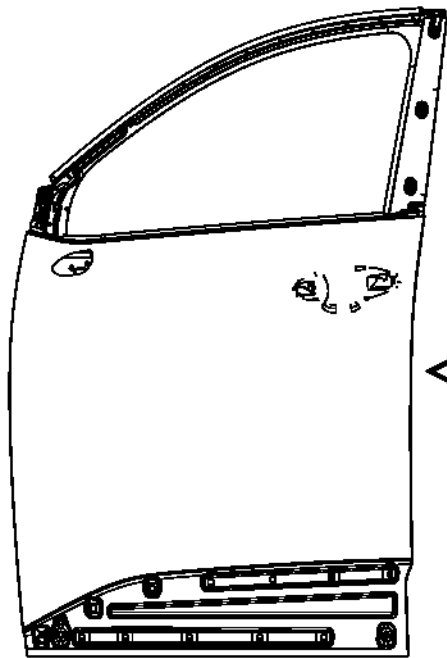

← "A"

TARGET AREA FOR
ORIGINALLY EQUIPPED PART

TARGET AREA FOR
REPLACEMENT PART

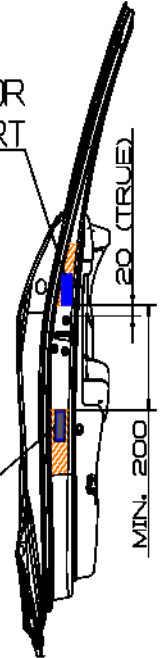

PNL ASSY-FR DR, LH/RH

VIEW "A"

Rear Door (LH/RH)

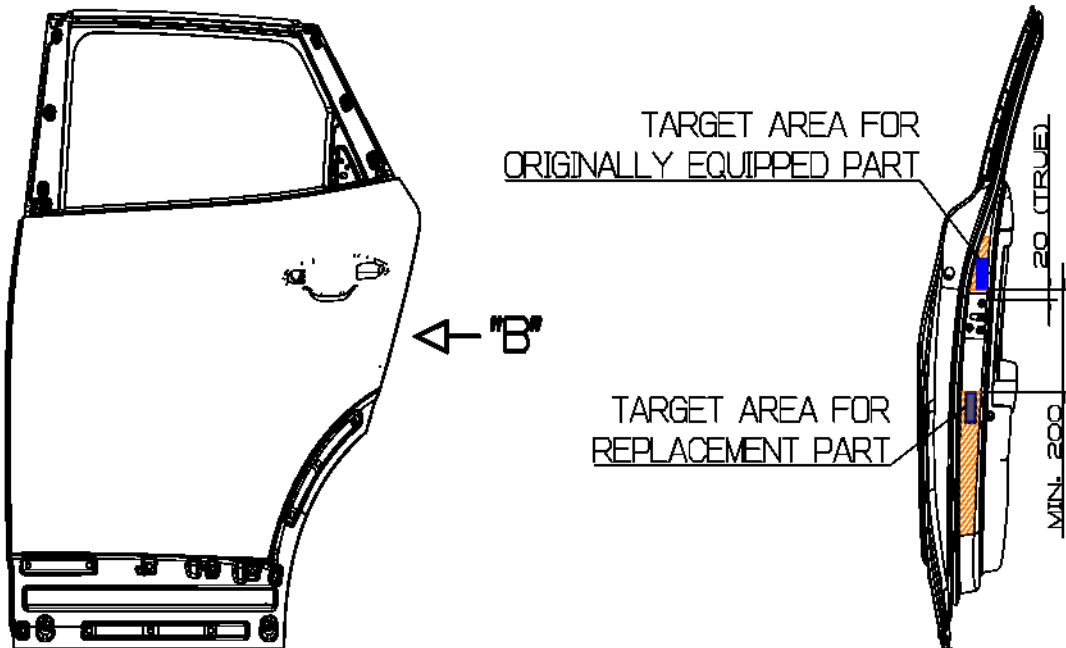

PNL ASSY-RR DR, LH/RH

VIEW "B"

Side Outer Panel (LH/RH)

TARGET AREA FOR
ORIGINALLY EQUIPPED PART (FOR NOS)

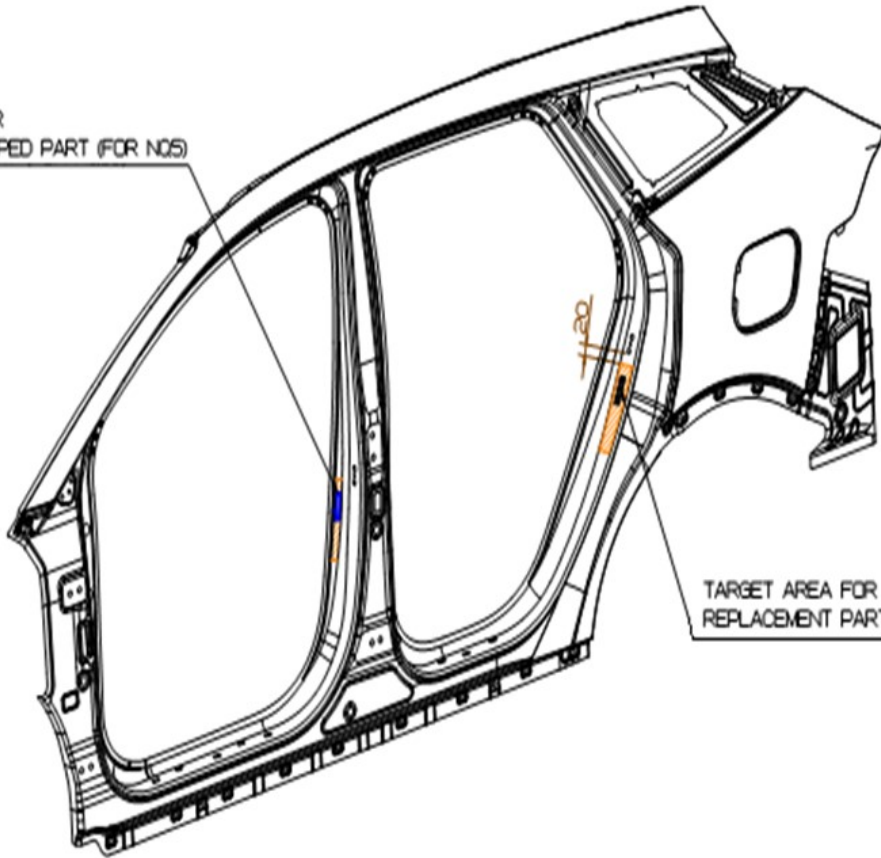

TARGET AREA FOR
REPLACEMENT PART (FOR NOS)

PNL-SIDE OTR, LH/RH

Manufactured in Korea

Side Outer Panel (LH/RH)

TARGET AREA FOR
REPLACEMENT PART (FOR N05a)

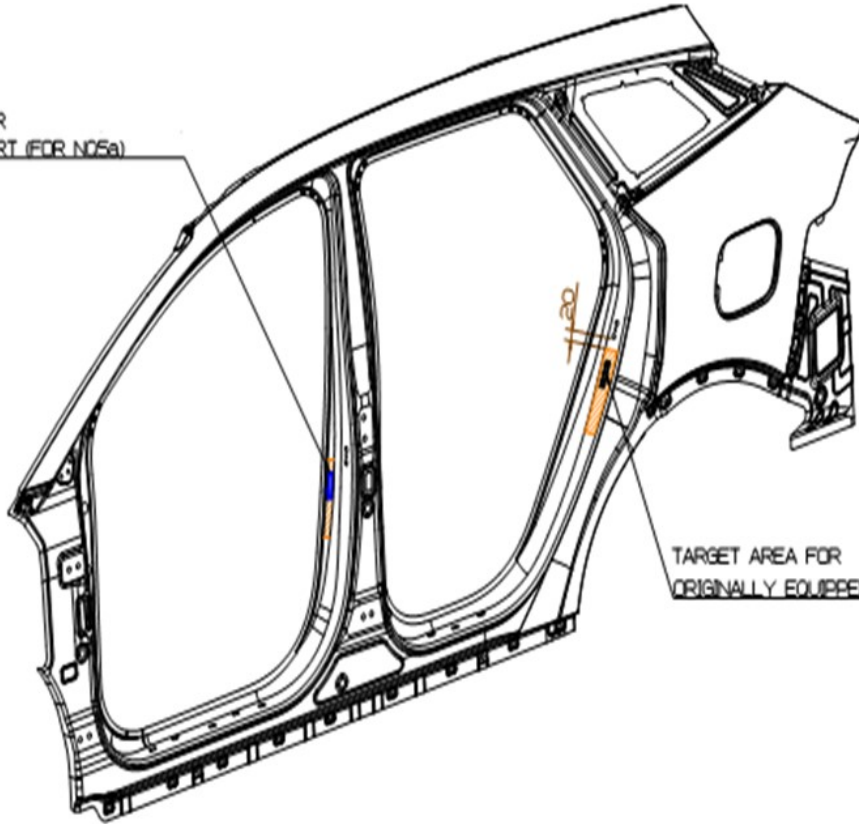

TARGET AREA FOR
ORIGINALLY EQUIPPED PART (FOR N05a)

PNL-SIDE OTR, LH/RH

Manufactured in Georgia, U.S.A

Front Bumper

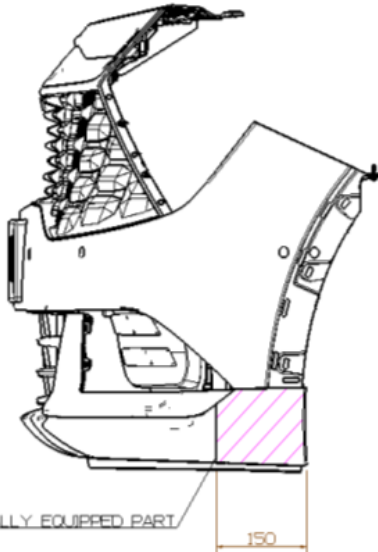

LABEL FOR ORIGINALLY EQUIPPED PART
(LH, INSIDE)

LABEL FOR REPLACEMENT PART
(RH, INSIDE)

(LABEL-VIN : 86465-R0300, 1EA)

FR BUMPER ASSY (STD)

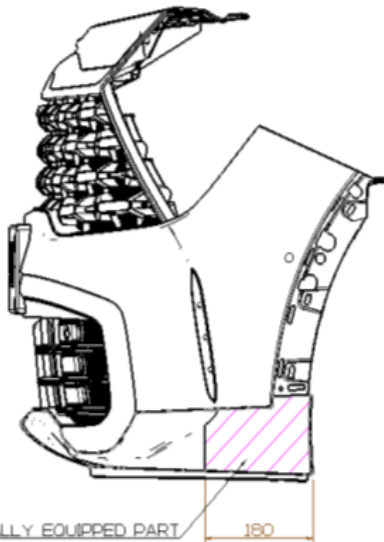

LABEL FOR ORIGINALLY EQUIPPED PART
(LH, INSIDE)

LABEL FOR REPLACEMENT PART
(RH, INSIDE)

(LABEL-VIN : 86465-R0300, 1EA)

FR BUMPER ASSY (X-LINE)

Rear Bumper

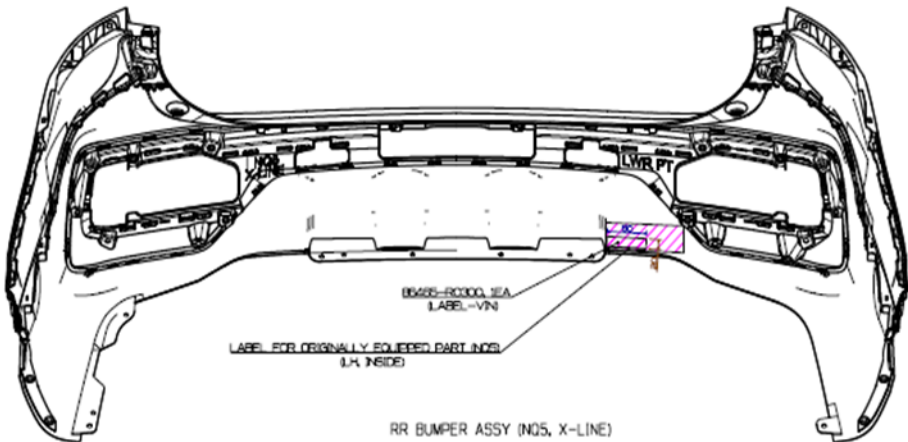
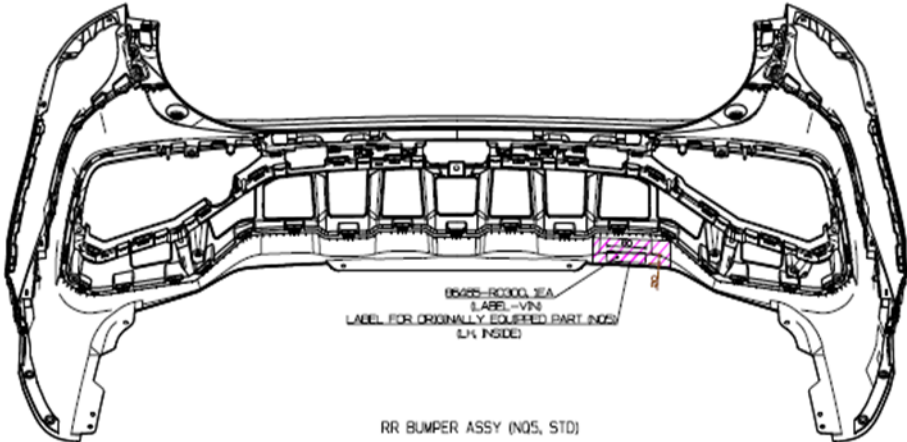

Manufactured in Korea

Rear Bumper

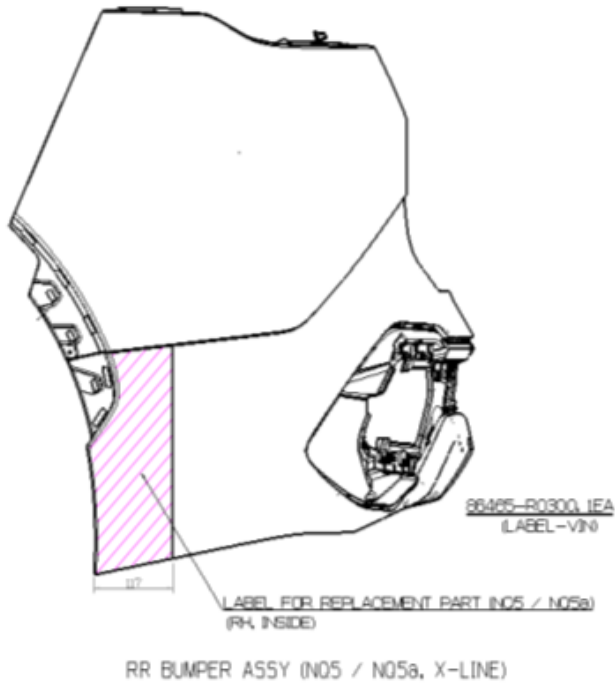
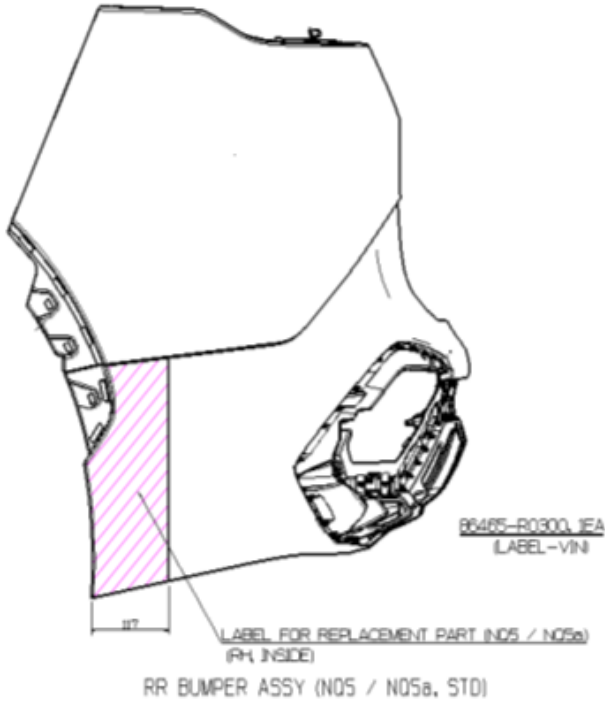

Manufactured in Korea

Rear Bumper

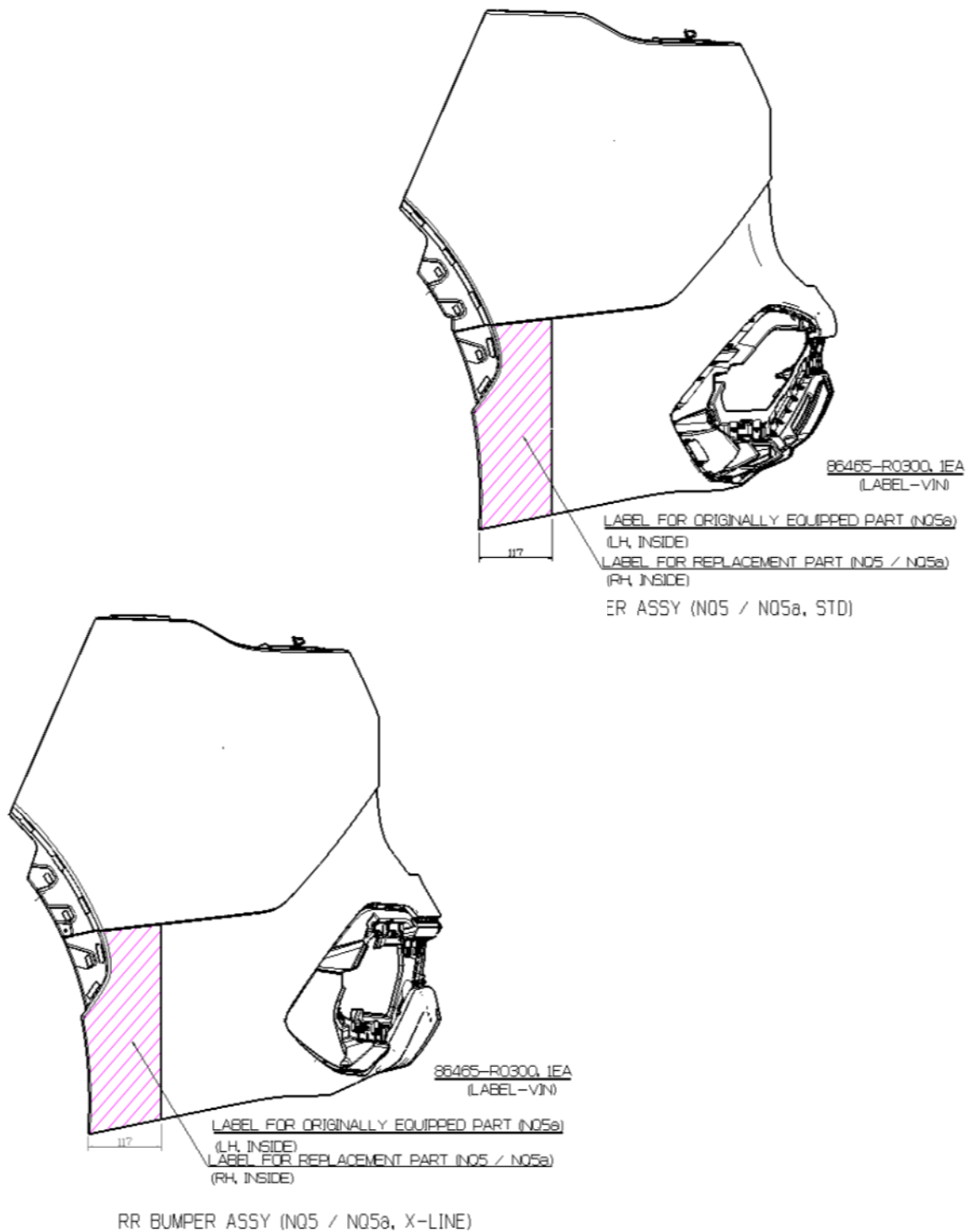

Engine (2.5 GDI Theta III)

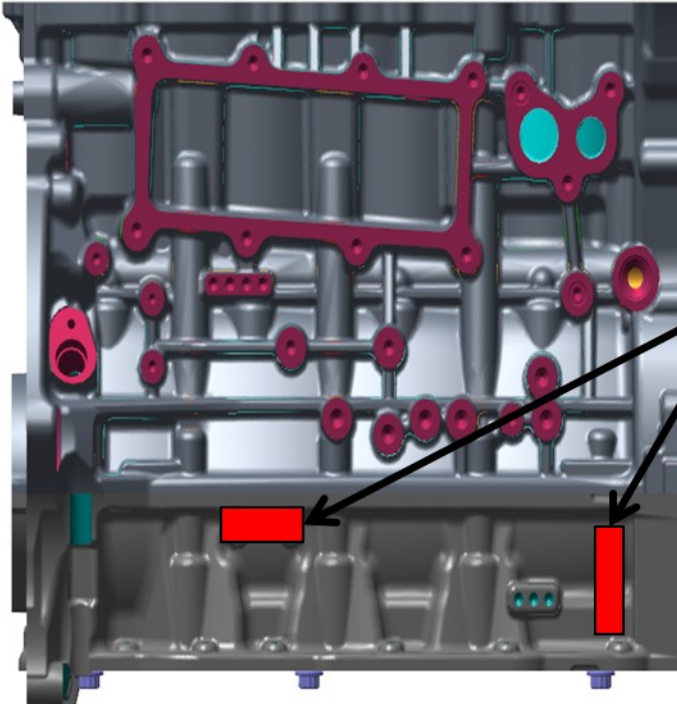

TARGET AREA FOR
ORIGINALLY EQUIPPED
PART
(VIN PLATE)

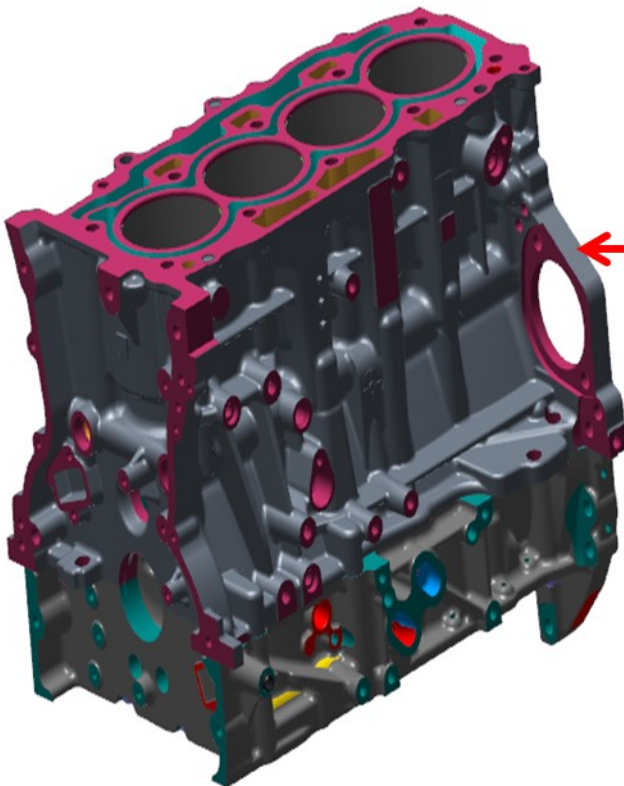

TARGET AREA FOR
REPLACEMENT PART

Transmission (Automatic, 2WD/4WD)

**TARGET AREA FOR
REPLACEMENT PART**

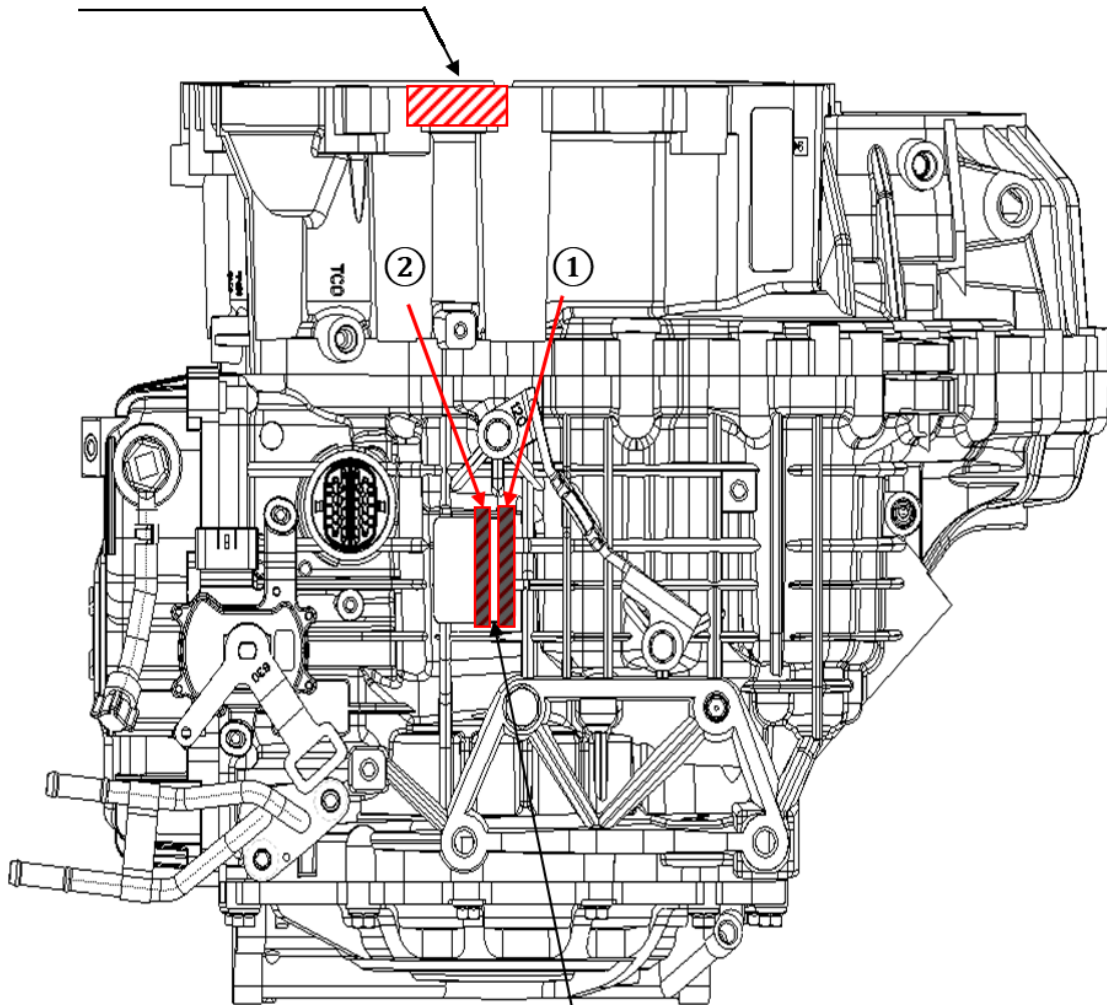

**TARGET AREA FOR
ORIGINALLY EQUIPPED PART**

**※ VIN plate for originally equipped part
will be attached to either ① or ②.**