



U.S. Department
of Transportation

**National Highway
Traffic Safety
Administration**



DOT HS 812 092

April 2021

Electric Vehicle GTR No. 20 Test Development, Validation, and Assessment

DISCLAIMER

This publication is distributed by the U.S. Department of Transportation, National Highway Traffic Safety Administration, in the interest of information exchange. The opinions, findings and conclusions expressed in this publication are those of the author(s) and not necessarily those of the Department of Transportation or the National Highway Traffic Safety Administration. The United States Government assumes no liability for its contents or use thereof. If trade or manufacturers' name or products are mentioned, it is because they are considered essential to the object of the publication and should not be construed as an endorsement. The United States Government does not endorse products or manufacturers.

Suggested APA Format Citation:

Schnorenberg, R., & Fleck, J. (2021, April). *Electric vehicle GTR test development, validation, and assessment* (Report No. DOT HS 812 092). National Highway Traffic Safety Administration.

Technical Report Documentation Page

1. Report No. DOT HS 812 092	2. Government Accession	3. Recipient's Catalog No.	
4. Title and Subtitle Electric Vehicle GTR Test Development, Validation, and Assessment	5. Report Date April 2021		6. Performing Organization Code
	8. Performing Organization Report No.		
7. Authors Robert Schnorenberg, Project Engineer, Joe Fleck, Project Engineer		10. Work Unit No.	
9. Performing Organization Name and Address MGA Research Corporation 5000 Warren Road Burlington, WI 53105		11. Contract or Grant No. 693JJ918F000059	
		13. Type of Report and Period Covered Final Report May 6, 2019 to February 14, 2020	
12. Sponsoring Agency Name and Address National Highway Traffic Safety Administration Office of Crashworthiness Standards (NRM-100) 1200 New Jersey Avenue SE Washington, DC 20590		14. Sponsoring Agency Code NHTSA NRM-100	
		15. Supplementary Notes	
16. Abstract A global technical regulation for electric vehicles (GTR No. 20) was established in the Global Registry on March 14, 2018. GTR No. 20 introduced performance-oriented requirements that address potential safety risks of electric vehicles while in use and after a crash event, including electrical shocks associated with the high-voltage circuits of electric vehicles and potential hazards associated with lithium-ion batteries and/or other rechargeable electric energy storage systems. To assess the requirements of GTR No. 20, NHTSA initiated an effort to develop a detailed laboratory test procedure and conduct the associated tests on a commercially available electric vehicle. A model year 2019 Chevrolet Bolt was chosen. This project only sought to cover the in-use requirements of the GTR's sections 5.1, 5.3, and 5.4. This report outlines the draft test procedures that were developed for this project and the results of the in-use testing on the 2019 Chevrolet Bolt. Revised test procedures will be developed based on the findings of this project.			
17. Key Words Global Technical Regulation, GTR 20, electric vehicle safety, Chevy Bolt, test, validation		18. Distribution Statement Document is available to the public from the National Technical Information Service, www.ntis.gov.	
19. Security Classification of Report Unclassified	20. Security Classification of Page Unclassified	21. No. of Pages 108	22. Price

Table of Contents

1. Introduction.....	1
2. Developed Test Procedures	3
2.1. Test Facility and Equipment Requirements.....	3
2.2. Draft Test Procedures	4
2.2.1. (5.1.1) Protection against electric shock.....	4
2.2.2. (5.1.1.1) Protection against direct contact	5
2.2.3. (5.1.1.2) Protection against indirect contact	12
2.2.4. (5.1.2) Functional safety	23
2.2.5. (5.3) Requirements with regard to installation and functionality of REESS in a vehicle.....	28
2.2.6. (5.4.5) External short circuit protection.....	31
2.2.7. (5.4.6) Over-charge protection.....	33
2.2.8. (5.4.7) Over-discharge protection	35
2.2.9. (5.4.8) Over-temperature protection	37
2.2.10. (5.4.9) Over-current protection	38
2.2.11. Appendix A: Probe inspection procedures	40
2.2.12. Appendix B: Resistance evaluations.....	42
2.2.13. Appendix C: Standard cycle	43
2.2.14. Appendix D: Isolation resistance	43
3. Validation Results, Discussion, and Feedback	46
3.1. Protection Against Direct Contact (5.1.1.1).....	48
3.1.1. Procedure feedback and revisions.....	48
3.1.2. Validation testing results and discussion	49
3.2. Protection Against Indirect Contact (5.1.1.2).....	53
3.2.1. Procedure feedback and revisions.....	53
3.2.2. Validation testing results and discussion	53
3.3. Functional Safety (5.1.2).....	54
3.3.1. Procedure feedback and revisions.....	54
3.3.2. Validation testing results and discussion	54

3.4. Requirements With Regard to Installation and Functionality of REESS in a Vehicle (5.3)	59
3.4.1. Procedure feedback and revisions.....	59
3.4.2. Validation testing results and discussion	59
3.5. Safety of REESS In-Use (5.4)	60
3.5.1. Procedure feedback and revisions.....	60
3.6. External Short Circuit Protection (5.4.5)	63
3.6.1. Procedure feedback and revisions.....	63
3.6.2. Validation testing results and discussion (6.2.5)	63
3.7. Over-Charge Protection (5.4.6).....	67
3.7.1. Procedure feedback and revisions.....	67
3.7.2. Validation testing results and discussion (6.2.6)	67
3.8. Over-Discharge Protection (5.4.7).....	72
3.8.1. Procedure feedback and revisions.....	72
3.8.2. Validation testing results and discussion (6.2.7)	72
3.9. Over-Temperature Protection (5.4.8).....	77
3.9.1. Procedure feedback and revisions.....	77
3.9.2. Validation testing results and discussion (6.2.8.5)	77
3.10. Over-Current Protection (5.4.9).....	83
3.10.1. Procedure feedback and revisions.....	83
3.10.2. Validation testing results and discussion (6.2.9)	83
4. Conclusions.....	89
Appendix A: Example of Pre-Test Information Sheet for GTR Testing.....	A-1

1. Introduction

In November 2011 a joint proposal by the United States, Japan, and the European Union sought to establish two working groups to address safety and environmental issues associated with electric vehicles. The objective of the working groups was to develop a globally harmonized regulation under the framework of the 1998 agreement. Consequently, a global technical regulation (GTR) for electric vehicles (GTR No. 20) was established in the Global Registry on March 14, 2018.

GTR No. 20 introduced performance requirements that address potential safety risks of electric vehicles while in use and after a crash event, including electrical shocks associated with the high-voltage circuits of electric vehicles and potential hazards associated with lithium-ion batteries and/or other rechargeable electric energy storage systems.

The objective of this project was to assess the requirements of GTR No. 20, develop a detailed laboratory test procedure, and conduct the associated tests on a commercially available electric vehicle. This test series will demonstrate the ability to conduct the tests in the GTR in an objective manner.

The following sections of GTR No. 20 were selected for evaluation in this report.

- 5.1.1.1 Protection against direct contact
- 5.1.1.2 Protection against indirect contact
- 5.1.2.1 Momentary indication when placed in active driving mode
- 5.1.2.2 Driver to be informed when leaving vehicle
- 5.1.2.4 Vehicle movement during charging
- 5.3.2 Warning in event of operation failure
- 5.3.3 Warning in case of thermal event in rechargeable electric energy storage system (REESS)¹
- 5.3.4 Warning in event of low energy content of REESS
- 5.4.5 External short circuit protection
- 5.4.6 Over-charge protection
- 5.4.7 Over-discharge protection
- 5.4.8 Over-temperature protection
- 5.4.9 Over-current protection

The detailed draft laboratory test procedure in section 2.2 of this report was developed in late 2018 by the contract test laboratory and NHTSA. Validation testing was conducted on a model

¹ REESS is defined in GTR No. 20 to mean the rechargeable electric energy storage system that provides electric energy for electrical propulsion. The REESS may include the necessary ancillary systems for physical support, thermal management, electronic controls and casing. A battery whose primary use is to supply power for starting the engine and/or lighting and/or other vehicle auxiliary systems is not considered as a REESS.

year 2019 Chevrolet Bolt electric vehicle using the draft test procedure. The vehicle manufacturer, NHTSA, and other subject matter experts were consulted to develop specific test methodologies related to the Chevrolet Bolt. The draft test procedure and validation test results are presented in this report, along with revisions that were made to the draft test procedure during the validation testing and recommendations based on the lessons learned during testing.

2. Developed Test Procedures

2.1. Test Facility and Equipment Requirements

The following equipment is suggested for conducting the tests defined in the draft test procedure in section 2.2. General requirements are provided where appropriate, along with the specific equipment used in the validation testing performed on the 2019 Chevrolet Bolt.

Equipment used for multiple tests

- Battery tester/cycler for performing standard cycles, over-charge, over-discharge, and overcurrent. Exact specifications depend on vehicle battery parameters and test methodology, but a NHR 9300 series battery tester was used for the validation testing in this report.
- Digital multimeter to measure DC voltages from 0 V to 1,000 V with a minimum safety classification of CAT III according to IEC 61010 and internal impedance $\geq 10 \text{ M}\Omega$. A Fluke 289 True-RMS multimeter was used for the validation testing in this report.
- Battery temperature monitoring equipment using one of the following methods:
 - Test lab supplied thermocouples and data logger.
 - Vehicle manufacturer specified diagnostic tool capable of recording battery temperature messages from vehicle CAN bus. In this test series, the vehicle manufacturer used its Multiple Diagnostic Interface 2 equipment with proprietary software to communicate with the battery management system for the over-charge, over-discharge, and overcurrent validation tests.
 - CAN interface with the vehicle manufacturer database file capable of recording battery temperature messages from the vehicle's CAN bus. A Vector VN1610A CAN interface was used for the external short circuit validation test.
- Breakout harnesses as specified by the vehicle manufacturer to accommodate connecting test lab equipment to the vehicle. Several different breakout harnesses may be required, depending on the test methodologies used for each specific vehicle.

Protection Against Electrical Shock Test Equipment (GTR No. 20 Section 5.1.1)

- IPXXB and IPXXD test probes: Educated Design & Development test probe models TFP-01 and TRP-02 were used for the validation tests in this report.
- Either of the following sets of equipment can be used:
 - Resistance tester with a current flow $\geq 0.2 \text{ A}$ and a resolution $\geq 0.01 \text{ }\Omega$. Test leads must be able to measure resistance of two points up to 2.5 m apart. A Hioki RM3548 multimeter was used for the validations in this report.
 - DC power supply with a current output $\geq 0.2 \text{ A}$ and a minimum resolution of 0.01 A, a multimeter with a minimum resolution of 0.001 V.
- A minimum internal resistance of $10 \text{ M}\Omega$ is required for the isolation voltage measurement device.

External Short Circuit Test Equipment (GTR No. 20 Section 5.4.5)

- Short circuit contactor with a total system resistance $\leq 0.5 \text{ m}\Omega$.
- Shunt or other method for measuring current. A 30,000-amp capacity shunt was used for validation testing.
- Data loggers to record voltage measurements across the shunt. The following data acquisition systems were used for the short circuit validation test.
 - DTS TDAS data acquisition collecting at 20,000 samples per second
 - DATAQ data logger collecting at 1,000 samples per second

Over-Temperature Protection Test Equipment (GTR No. 20 Section 5.4.8)

- Vehicle dynamometer to support drive profile used for testing.
- Vehicle controller to provide inputs to the accelerator pedal or vehicle to perform the specified drive profile.
- Temperature chamber to soak the vehicle at 40 °C before being placed on the dynamometer.

Over-Current Protection Test Equipment (GTR No. 20 Section 5.4.9)

- DC charger compatible with the electric vehicle being tested. A 50 kW DC fast charger with CCS 1 cable was leased from EV Safe Charge Inc.² to perform the overcurrent validation test in this report.

2.2. Draft Test Procedures

2.2.1. (5.1.1) Protection against electric shock

These electrical safety requirements apply to high-voltage (HV) buses under conditions where they are not connected to external electric power supply.

Power down the vehicle according to the vehicle owner’s manual or manufacturer-supplied information. Verify the vehicle is not connected to an external power supply or charger. Close all vehicle charging port doors.

External power supply or charger disconnected: ___Yes ___No

Charging port doors closed: ___Yes ___No

Soak the vehicle at $20 \pm 10 \text{ }^\circ\text{C}$. Allow the vehicle exterior and interior to reach the desired temperature for 30 minutes.

Temperature reached for 30 minutes: ___Yes ___No

Record the nominal state of charge (SOC) of the rechargeable electrical energy storage system (REESS) following the owner’s manual or manufacturer-supplied information.

Nominal SOC of the REESS: _____

² Los Angeles, CA.

Power up the vehicle according to the vehicle owner’s manual or manufacturer-supplied information and verify the vehicle can achieve “ready mode..” Verify all HV systems are functional. Document/photograph any indication to the driver of the SOC of the REESS.

Indication to SOC of the REESS: _____

2.2.2. (5.1.1.1) Protection against direct contact

(5.1.1.1.1) IPXXD protection

The passenger compartment and luggage compartment of the vehicle shall comply with paragraph 5.1.1.1.1 of GTR No. 20.

Soak the vehicle at 20 ± 10 °C. Allow the vehicle exterior and interior to reach the desired temperature for 30 minutes. Power up the vehicle according to the vehicle owner’s manual or manufacturer-supplied information and verify the vehicle is in “ready mode.”

IMPORTANT: Use caution throughout the direct contact procedure and assume high voltage is present in the vehicle.

Power down the vehicle. Identify all accessible components and connectors located in the passenger compartment and luggage compartment that might contain high voltage using visual inspection and manufacturer-supplied information. These components and connectors shall hereinafter be referred to as “HV locations.” Photograph and document the HV locations in Table 1.

Table 1

HV Location	Picture/Documentation

Open, disassemble, or remove all removable parts in the passenger compartment and luggage compartment without the use of tools. Separate connectors that meet paragraph 5.1.1.1 of GTR No. 20 without the use of tools. Identify all HV locations in the passenger compartment and luggage compartment using visual inspection and manufacturer-supplied information. Photograph and document the HV locations in Table 2.

Table 2

HV Location	Picture//Documentation

IPXXD PROBE INSPECTION:

Follow the procedure in Appendix A for IPXXD probe inspection in the passenger compartment and luggage compartment.

Table 3

HV Location	Picture/Documentation of Voltage Measurement

Table 4

HV Location	Picture/Documentation of Continuity

Does the vehicle meet protection degree IPXXD? ___ Yes ___ No

If “No,” contact the COR and stop all further inspection.

(5.1.1.1.2) Protection degree IPXXB

Areas other than the passenger compartment or luggage compartment of the vehicle shall comply with paragraph 5.1.1.1.2 of GTR No. 20.

Power up the vehicle according to the vehicle owner’s manual or manufacturer-supplied information and verify the vehicle is in “ready mode.”

IMPORTANT: Use caution throughout the direct contact procedure and assume high voltage is present in the vehicle.

Power down the vehicle. Identify all HV locations located outside the passenger compartment and luggage compartment using visual inspection and manufacturer-supplied information. A vehicle lift may be required to access and inspect the vehicle underbody. Photograph and document the HV locations in Table 5.

Table 5

HV Location	Picture/Documentation

Open, disassemble, or remove all removable parts outside the passenger compartment and luggage compartment without the use of tools. Separate connectors that don’t meet paragraph 5.1.1.1 of GTR No. 20 without the use of tools. Identify all HV locations outside the passenger compartment and luggage compartment using visual inspection and manufacturer-supplied information. Photograph and document the HV locations in Table 6.

Table 6

HV Location	Picture/Documentation

IPXXB PROBE INSPECTION:

Follow the procedure in Appendix A for IPXXB probe inspection outside the passenger compartment and luggage compartment.

Table 7

HV Location	Picture/Documentation of Voltage Measurement

Table 8

HV Location	Picture/Documentation of Continuity

Does the vehicle meet protection degree IPXXB? Yes No

If “No,” contact the COR and stop all further inspection.

(5.1.1.1.3) Service disconnect

If the vehicle is equipped with a high-voltage service disconnect, it shall comply with paragraph 5.1.1.1.3 of GTR No. 20.

Review the procedure for opening, disassembling, or removing the high-voltage service disconnect according to the vehicle owner’s manual or manufacturer-supplied information. Take note of any parts or components that must be opened, disassembled, or removed without the use of tools in order to access the service disconnect.

Can the high-voltage service disconnect be accessed and removed without the use of tools?

Yes _____

No _____ (section complete)

Soak the vehicle at 20 ± 10 °C. Allow the vehicle exterior and interior to reach the desired temperature for 30 minutes. Power down the vehicle. Identify the location of the high-voltage service disconnect using visual inspection and manufacturer-supplied information. Photograph and document the service disconnect and surrounding area in Table 9.

Table 9

Service Disconnect	Picture/Documentation

Open, disassemble, or remove all components and parts that must be opened, disassembled, or removed to access the service disconnect without the use of tools. Photograph and document the service disconnect and surrounding area in Table 10.

Table 10

Service Disconnect	Picture/Documentation

Open, disassemble, or remove the high-voltage service disconnect without the use of tools. Photograph and document the service disconnect and surrounding area in Table 11.

Table 11

Service Disconnect	Picture/Documentation

IPXXB PROBE INSPECTION:

Follow the procedure in Appendix A for IPXXB probe inspection for a high-voltage service disconnect.

Table 12

HV Location	Picture/Documentation of Voltage Measurement

Table 13

HV Location	Picture/Documentation of Continuity

Does the high-voltage service disconnect meet protection degree IPXXB? ___ Yes ___ No

If “No,” contact the COR and stop all further inspection.

(5.1.1.1.4) Marking

The vehicle shall comply with paragraphs 5.1.1.1.4.1 to 5.1.1.1.4.3 of GTR No. 20.

Soak the vehicle at 20 ± 10 °C. Allow the vehicle exterior and interior to reach the desired temperature for 30 minutes. Power down the vehicle. Identify the REESS and all enclosures, electrical protection barriers and cables for high-voltage buses located outside an enclosure using visual inspection and manufacturer-supplied information. A vehicle lift may be required to access and inspect the vehicle underbody. Without using any tools open, disassemble, or remove all parts and components that can be opened, disassembled, or removed in order to access the REESS, enclosures, electrical protection barriers, and high-voltage cables.

The symbol shown in Figure 1, of this report, indicates high-voltage capability and shall be present on or near the REESS and visible on all enclosures and electrical protection barriers. All cables for high-voltage buses located outside an enclosure shall have an outer covering with the color orange. Photograph and document these locations and cables including all HV labels and/or colors in Table 14.

Table 14

Location	Picture/Documentation	Is HV symbol and/or orange color present on or near the location? Yes/No, describe

Do all the locations in Table 14 comply with the corresponding requirements in paragraphs 5.1.1.1.4.1 to 5.1.1.1.4.3 of GTR No. 20? ___ Yes ___ No

If “No,” contact the COR and stop all further inspection.



Figure 1

2.2.3. (5.1.1.2) Protection against indirect contact

All exposed conductive parts on the vehicle shall comply with paragraphs 5.1.1.2.1 and 5.1.1.2.2 of GTR No. 20.

Soak the vehicle at 20 ± 10 °C. Allow the vehicle exterior and interior to reach the desired temperature for 30 minutes. Power up the vehicle according to the vehicle owner’s manual or manufacturer-supplied information and verify the vehicle is in “ready mode.”

IMPORTANT: Use caution throughout the indirect contact procedure and assume high voltage is present in the vehicle.

Power down the vehicle. Identify all HV locations with exposed conductive parts on the vehicle exterior or interior using visual inspection and manufacturer-supplied information. A vehicle lift may be required to access and inspect the vehicle underbody. Photograph and document the HV locations in Table 15.

Table 15

HV Location	Picture/Documentation

Open, disassemble, or remove all removable parts located on the vehicle exterior or interior without the use of tools. Identify all HV locations on the vehicle exterior or interior using visual inspection and manufacturer-supplied information. Photograph and document the HV locations in Table 16.

Table 16

HV Location	Picture/Documentation

IMPORTANT: Use extreme caution throughout the indirect contact procedure for HV locations in Tables 15 and 16 that are not conductively connected and secured to the electrical chassis with electrical wire or ground cable, by welding, or by connection using bolts, etc.

Determine the grounding connection for all components that protect HV locations listed in Tables 15 and 16 using visual inspection and manufacturer-supplied information. Photograph, describe, and document in Table 17 the grounding connection of all HV locations listed in Tables 15 and 16.

Table 17

HV Location	Is the location connected to the chassis? Yes/No	Connection description

Conduct a resistance evaluation on all components and connectors in Table 17. Use one of the two methods for resistance evaluation listed in Appendix B (“Resistance Tester” or “DC Power Supply”). Photograph and document the resistance evaluation in Table 18 or 19. Use Table 18 if the “Resistance Tester” method was chosen. Use Table 19 if the “DC Power Supply” method was chosen.

Table 18a (Resistance Tester)

HV Location	Resistance between location and chassis (Ω)

Table 18b (Resistance Tester)

HV Location	HV Location	Resistance between two HV locations less than 2.5 m apart (Ω)

Table 19a (DC Power Supply)

	Measure between HV location and electrical chassis		
HV Location	Voltage (V)	Current (A)	Resistance (Ω)

Table 19b (DC Power Supply)

		Measure between two HV locations less than 2.5m apart		
HV Location	HV Location	Voltage (V)	Current (A)	Resistance (Ω)

Do all the HV locations in Tables 17 comply with the corresponding requirements in paragraphs 5.1.1.2.1 and 5.1.1.2.2 of GTR No. 20? ___Yes ___No

If “No,” contact the COR and stop all further inspection.

(5.1.1.2.3) Grounded external charging

Vehicles that are charged through a conductive connection to a grounded external electric power supply shall comply with paragraph 5.1.1.2.3 of GTR No. 20.

Review the charging procedure for the vehicle using the owner’s manual or manufacturer-supplied information. NOTE: The manufacturer needs to specify or provide a connector and necessary instructions or drawings to confirm the ground contact is closed before the high-voltage contactors are closed.

Soak the vehicle at 20 ± 10 °C. Allow the vehicle exterior and interior to reach the desired temperature for 30 minutes. Power down the vehicle. Identify the location of the ground point on the vehicle connector and the vehicle inlet using visual inspection and manufacturer-supplied information. Photograph and document the ground points in Table 20.

Table 20

Location	Picture/Documentation

Connect the vehicle connector to the vehicle inlet following the charging procedure provided by the manufacturer. Confirm the ground contactor is closed before the HV contactors are closed using a manufacturer-specified connector and instructions, visual inspection, or part drawings. Photograph and document the confirmation in Table 21.

Table 21

Ground Confirmation	Picture/Documentation

Does the vehicle comply with paragraph 5.1.1.2.3 of GTR No. 20? ___ Yes ___ No

If “No,” contact the COR and stop all further inspection.

(5.1.1.2.4) Isolation resistance

The electric power train of the vehicle shall comply with paragraphs 5.1.1.2.4.1 and 5.1.1.2.4.2 of GTR No. 20.

Vehicles with electrical circuits that are galvanically connected to each other, where the DC part of these circuits is connected to the electrical chassis and the specific voltage condition is fulfilled need not comply with paragraphs 5.1.1.2.4.1 and 5.1.1.2.4.2 of GTR No. 20.

Determine if the vehicle's power train consists of DC and AC buses that are conductively isolated from each other or DC and AC buses that are conductively connected to each other using the vehicle owner's manual and manufacturer-supplied information. Identify measurement locations to monitor the voltages of these buses.

Soak the vehicle at 20 ± 10 °C. Allow the vehicle exterior and interior to reach the desired temperature for 30 minutes. Verify the vehicle is at full charge. Power up the vehicle according to the vehicle owner's manual or manufacturer-supplied information and verify the vehicle is in "ready mode."

IMPORTANT: Use caution throughout the isolation resistance procedure and assume high voltage is present in the vehicle.

Measure the isolation resistance between the high-voltage buses and the electrical chassis. Use one of the two methods for isolation resistance listed in the following section. Photograph and document the appropriate values in Tables 22 to 26. Use Tables 22 and 23 for separate DC and AC buses. Use Tables 24 to 26 for combined DC and AC buses.

Isolation resistance for DC and AC buses that are conductively isolated:

Measure the isolation resistance for the DC and AC buses following the Isolation Resistance Procedure in Appendix D. Document the appropriate values in Table 22 and 23.

Table 22a DC bus

Measured Values	Resistor value used	Calculated electrical isolation
Vb	Ro=	
V1		
V2		
V1'		
V2'		

Table 22b AC bus

Measured Values	Resistor value used	Calculated electrical isolation
Vb	Ro=	
V1		
V2		
V1'		
V2'		

Table 23

High-voltage Bus	Working Voltage	Isolation Resistance Value
AC		
DC		

Does the vehicle comply with paragraph 5.1.1.2.4.1 of GTR No. 20 (100 Ω/V DC and 500 Ω/V AC)?

Yes

No

If “No,” contact the COR and stop all further inspection.

Isolation resistance for DC and AC Buses that are conductively connected:

Determine if the AC buses fulfil the specifications in paragraph 5.1.1.2.4.2.a or 5.1.1.2.4.2.b of GTR No. 20 using visual inspection and manufacturer-supplied information. Photograph and document any confirmation of the AC bus meeting these specifications in Table 24.

Table 24

AC Bus	Picture/Documentation

Measure the isolation resistance for the DC and AC buses following the Isolation Resistance Procedure in Appendix D. Document the appropriate values in Table 25 and 26.

Table 25

Measured Values	Resistor value used	Calculated electrical isolation
Vb	Ro=	
V1		
V2		
V1'		
V2'		

Table 26

High-voltage Bus	Working Voltage	Isolation Resistance Value
AC		
DC		

Does the vehicle comply with paragraph 5.1.1.2.4.2 of GTR No. 20 (500 Ω /V)?

___ Yes ___ No

If "No," contact the COR and stop all further inspection.

NOTE: Any confirmation found in Table 24 will change the minimum isolation resistance value to 100 Ω /V.

(5.1.1.2.4.3) Isolation resistance for fuel cell vehicles

Fuel cell vehicles shall comply with paragraph 5.1.1.2.4.3 of GTR No. 20.

Soak the vehicle at 20 ± 10 °C. Allow the vehicle exterior and interior to reach the desired temperature for 30 minutes. Verify the vehicle is at full charge. Power up the vehicle according to the vehicle owner’s manual or manufacturer-supplied information and verify the vehicle is in “ready mode.”

IMPORTANT: Use caution throughout the procedure and assume high voltage is present in the vehicle.

Determine the isolation resistance of the electric power train using the Isolation Resistance Procedure in Appendix D or using manufacturer-supplied information. Document the appropriate values in Tables 27 and 28.

Table 27

Measured Values	Resistor value used	Calculated electrical isolation
Vb	Ro=	
V1		
V2		
V1'		
V2'		

Table 28

High Voltage Bus	Working Voltage	Isolation Resistance Value
AC		
DC		

Determine if the vehicle has an on-board isolation resistance monitoring system using the vehicle owner’s manual and manufacturer-supplied information. Identify the location of the isolation resistance monitoring system warning and confirm that the warning is not triggered to indicate an isolation value below $100 \Omega/V$. Photograph and document the location of the warning in Table 29.

Table 29

Location	Picture/Documentation

Test the on-board isolation resistance monitoring system using the following steps:

Use the isolation resistance determined from Appendix D and the following equations to calculate the resistor required for testing:

If the minimum isolation resistance is 100 Ω/V:

$$1/(1/95xV)-1/R_i) \leq R_o < 1/(100xV) - 1/R_i), \text{ where } V \text{ is the working voltage.}$$

If the minimum isolation resistance is 500 Ω/V:

$$1/(1/475xV)-1/R_i) \leq R_o < 1/(500xV) - 1/R_i), \text{ where } V \text{ is the working voltage.}$$

Power up the vehicle according to the vehicle owner’s manual or manufacturer-supplied information and verify the vehicle is in “ready mode.”

IMPORTANT: Use caution throughout the procedure and assume high voltage is present in the vehicle.

Position a real-time camera (30fps) to view the location of the isolation monitoring system warning. Connect one end of the resistor, R_o , to the positive terminal of the electrical power train and the other end to the vehicle chassis. Document any indication provided to the driver for loss of electrical isolation in Table 30.

Table 30

Location	Picture/Documentation

Does the vehicle comply with paragraph 5.1.1.2.4.3 of GTR No. 20? ___ Yes ___ No

If “No,” contact the COR and stop all further inspection.

(5.1.1.2.4.4) Isolation resistance for external AC charging

Review the owner’s manual to verify the vehicle’s REESS can be charged externally with AC type charger.

Vehicles that are charged with an AC external electric power supply shall comply with paragraph 5.1.1.2.4.4 of GTR No. 20.

Identify measurement locations to monitor the charging port connection to the REESS using visual inspection or manufacturer-supplied information.

Soak the vehicle at 20 ± 10 °C. Allow the vehicle exterior and interior to reach the desired temperature for 30 minutes. Verify the vehicle is at full charge. Power up the vehicle according to the vehicle owner’s manual or manufacturer-supplied information and verify the vehicle is in “ready mode.”

IMPORTANT: Use caution throughout the procedure and assume high voltage is present in the vehicle.

Measure the isolation resistance for the DC and AC buses following the Isolation Resistance Procedure in Appendix D. Document the appropriate values in Table 30 and 31.

Table 30

Measured Values	Resistor value used	Calculated electrical isolation
Vb	Ro	Ri
V1		
V2		

Table 31

High-voltage Bus	Working Voltage	Isolation Resistance Value
AC		
DC		

Does the vehicle comply with paragraph 5.1.1.2.4.4 of GTR No. 20? ___ Yes ___ No

If “No,” contact the COR and stop all further inspection.

2.2.4. (5.1.2) Functional safety

(5.1.2.1) Momentary indication when placed in active driving mode

Soak the vehicle at 20 ± 10 °C. Allow the vehicle exterior and interior to reach the desired temperature for 30 minutes. Remove all external charging devices and close all charging port doors. Verify the SOC of the vehicle is in normal operating range. Install a real-time camera (30 fps) to record any indications to the driver.

1. Does an internal combustion engine directly or indirectly provide the vehicle's propulsion power upon startup?

Yes____ (section complete) No____

2. Start recording of the real-time camera.

3. Power up the vehicle according to the vehicle owner's manual or manufacturer-supplied information and verify the vehicle is in "ready mode" and "park" position.

Document visible/audible indications to a driver of the "ready mode."

3. Depress the brake pedal (if applicable) and place the vehicle in the forward active driving mode.

4. Look for an indication that the electric power train will move the vehicle and document in the Table 32.

5. Release the brake pedal (if applicable) or apply pressure to the accelerator pedal to verify vehicle is in forward active driving mode.

6. Return the vehicle to the park position.

7. Power down/turn off the vehicle.

8. Power up the vehicle according to the vehicle owner's manual or manufacturer-supplied information and verify the vehicle is in "ready mode" and "park" position.

9. Depress the brake pedal (if applicable) and place the vehicle in the reverse active driving mode.

10. Look for an indication that the electric power train will move the vehicle and document in the Table 32.

11. Release the brake pedal (if applicable) or apply pressure to the accelerator pedal.

12. Return the vehicle to the park position and power down the vehicle and stop recording the real-time camera.

Table 32

Propulsion System Status	Signal Type/Audible or Teltale	Symbol Present	Symbol Description	Location
Startup				
Startup - Forward				
Startup - Reverse				

(5.1.2.2) Driver to be informed leaving vehicle

Soak the vehicle at 20 ± 10 °C. Allow the vehicle exterior and interior to reach the desired temperature for 30 minutes. Remove all external charging devices and close all charging port doors. Verify the SOC of the vehicle is in normal operating range. Install a real-time camera (30 fps) to record any indications to the driver.

1. Install wheel stops to prevent vehicle rollaway.
2. Start recording of the real-time camera. Power the vehicle to the On/Run position and verify the vehicle READY light is illuminated.
3. Place the vehicle in the drive/forward position.
4. With the brake still depressed open the driver door and observe any indication from the vehicle that it is still in the active driving possible mode. Document in Table 33.
5. Close the driver door, return the vehicle to the park position and power down/turn off the vehicle.
6. Power up/turn on the vehicle and verify the vehicle READY light is illuminated.
7. Place the vehicle in drive/forward position with the brake pedal depressed (if equipped).
8. The use of wheel stops to prevent rollaway is suggested before release of the brake. Release the brake (if equipped).
9. Open the driver door and observe any indication from the vehicle that it is still in active driving possible mode. Document in Table 33.
10. Close the driver door and return the vehicle to the park position. Power down/turn off the vehicle.
11. Power up/turn on the vehicle and verify the vehicle Ready light is illuminated.
12. Repeat steps 2 – 8 for the reverse position.

Table 33

Gear	Signal Type/Audible or Telltale	Symbol Present	Symbol Description	Location
Forward with brake				
Reverse with brake				
Forward without brake				
Reverse without brake				

(5.1.2.3) State of drive direction shall be identified

Soak the vehicle at 20 ± 10 °C. Allow the vehicle exterior and interior to reach the desired temperature for 30 minutes. Remove all external charging devices and close all charging port doors. Verify the SOC of the vehicle is in normal operating range. Install a real-time camera (30 fps) to record any indications to a driver.

1. Install wheel stops to prevent vehicle rollaway.
2. Start recording of the real-time camera.
3. Power the vehicle to the On/Run position and verify the vehicle is in Drive Ready State and still in the park position.
4. Place the vehicle in forward direction.

Document visible/audible indications of the forward drive state.

5. Place the vehicle into the park position.
6. Place the vehicle in reverse direction.

Document visible/audible indications of the reverse drive state.

7. Return the vehicle to the park position.
8. Power down/ turn off the vehicle.

Table 34

Gear	Signal Type/Audible or Telltale	Symbol Present	Symbol Description	Location
Forward				
Reverse				

(5.1.2.4) If REESS can be externally charged, vehicle cannot move while connected

Soak the vehicle at 20 ± 10 °C. Allow the vehicle exterior and interior to reach the desired temperature for 30 minutes. Remove all external charging devices and close all charging port doors. Verify the SOC of the vehicle is below 90 percent of full operating range. Install a real-time camera (30 fps) to record any indications to a driver.

1. Review the owner’s manual or manufacturer’s provided information to determine if the RESS be externally charged.

Yes _____ No _____ (section complete)

2. Record the type of charger(s) recommended by the manufacture in the Table 35.

Table 35

Voltage	Voltage Level	Voltage Level	Voltage Level	Other
AC				
DC				

1. Power up/turn on the vehicle and verify that the state of charge (SOC) of the REESS is below 90 percent.
2. Place the vehicle in the drive/forward position and verify the function of the electrical power train.
3. Place the vehicle in “Park” and power down the vehicle.
4. Attach a plumb bob, or similar device, in indicate vehicle position at the front and rear centerline of the vehicle. Mark the starting location of the vehicle in front and back with reference to the ground.
5. Following the owner’s manual or manufacturer’s provided directions, connect the appropriate vehicle charge connector to the vehicle’s charge port. Document any indication by the charger or vehicle that charging has commenced.
6. Power up/turn on the vehicle and place the vehicle in drive/forward position. Ensure all occupant doors and cargo hatches not required for charging remain closed during this step. Is the drive/forward active for the electrical power train?
 Yes _____ No _____ (go to step 11)
7. Depress accelerator pedal to check for vehicle movement. Does the vehicle move under electric drive train power?
 Yes _____ No _____
8. If the vehicle moves, stop the vehicle movement after approximately 3 feet.
9. Record the amount of movement using the front and rear plum bob or similar device that was attached to the vehicle.
10. Place vehicle back in “park” and power down the vehicle.

11. Repeat steps 8-10 using reverse direction.
12. Remove the charger and close charging port door.
13. Repeat steps 3-10 for all AC/DC charge types.
14. Document in the results in the Table 36.

Table 36

Charger Voltage Type	Voltage Level	Vehicle Direction Forward/Reverse	Vehicle Movement Yes/No	Distance Traveled (Front)	Distance Traveled (Rear)
AC					
DC					

2.2.5. (5.3) Requirements with regard to installation and functionality of REESS in a vehicle

(5.3.2) Warning in the event of operational failure of vehicle controls that manage REESS safe operation.

Review information provided by the vehicle manufacturer. The information should contain one of the following:

___ A system diagram that identifies all the vehicles controls that manage REESS operations and identifies what components are used to generate a warning due to operational failure of vehicle controls.

___ A written explanation describing the basic operation of the vehicle controls that manage REESS operation. The manufacturer will identify components of the vehicle control system and describe their functions and capability to manage the REESS's A logic diagram, engaging the vehicle controls, and description of conditions that would lead to triggering of the warning system is also required.

Check Sheet (for systems that illuminate/display an indication upon startup)

1. Using the vehicle's owner's manual or manufacturer-supplied information, document the type and location of indication provided to the driver in the case of failure of REESS safe operation.
2. Is the vehicle equipped with an audible signal or optical signal that indicates to the driver a failure of REESS safe operation?

Audible _____ Optical _____

3. In the case of an optical signal, using a real-time camera (30fps) position the lens to record the tell-tale lamp when it is illuminated.

4. Start recording of the real-time camera.
5. Power up/turn on the vehicle and record the location of the tell-tale lamps. Did the tell-tale lamp illuminate or audible alarm sound?
Yes ____ (go to step 7) No ____
6. Place the vehicle in forward/drive position with the electrical power train engaged. Document any additional tell-tale lamps that illuminate.
7. Place the vehicle in Park position and power down/turn off the vehicle.
8. Stop recording the video camera once the tell-tale light extinguishes.

(5.3.3) Warning in the case of a thermal event in the REESS

Review information provided by the vehicle manufacturer. The information should contain the following:

____ Parameters and associated threshold levels that are used to indicate a thermal event to trigger the warning.

____ System diagram and written explanation describing the sensors and operation of the vehicle controls to manage the REESS in the event of a thermal event.

Check Sheet

1. Using the vehicle's owner's manual or information provided by the manufacturer document the type and location of indication provided to the driver in the case of a thermal event in the REESS.
2. Is the vehicle equipped with an audible signal or optical signal that indicates to the driver a thermal event in the REESS?

Audible _____

Optical _____

3. Using a real-time camera (30fps) position the lens to record the tell-tale lamp when it is illuminated.
4. Start recording of the real-time camera.
5. Power up/turn on the vehicle and record the location of the tell-tale lamps. Did the tell-tale lamp illuminate or audible alarm sound?
Yes _____ (go to step 7) No _____

6. Place the vehicle in forward/drive position with the electrical power train engaged. Document any additional tell-tale lamps that illuminate.
7. Place the vehicle in Park position and power down/turn off the vehicle.
8. Stop recording the video camera once the tell-tale light extinguishes.

(5.3.4) Warning in the event of low energy content of REESS

Review information provided by the manufacturer indicating the type of notification to the driver and state of charge used for the REESS low energy level warning.

Check Sheet

1. Using information provided in the owner’s manual or supplied by the manufacturer, record the voltage, SOC or range remaining of the REESS when the tell-tale lamp or indication to the driver is triggered.

Voltage _____ SOC _____ Range Remaining _____

2. Using a real-time camera (30fps) position the lens to record the tell-tale lamp when it is illuminated.
3. If the indication is illuminated during startup, power up the vehicle and record the illumination of the lamp.
4. Stop recording the video camera once the light extinguishes or after 20 seconds.

2.2.6. (5.4.5) External short circuit protection

Review the owner’s manual or manufacturer’s provided information to determine the maximum state of charge (SOC) of the vehicle. For vehicles that can be externally charged, identify which type of charging will provide the maximum SOC. For vehicles that are only rechargeable using an energy source on the vehicle, identify the manufactures method to reach the maximum SOC.

Maximum SOC _____

1. Soak the test vehicle or REESS components at in 20 ± 10 °C temperature for 4 hours. Power up the vehicle/REESS and record the SOC of the vehicle/REESS.

SOC _____

2. Is the SOC above 95 percent as outlined by the manufacturer?

Yes _____ (go to step 4) No _____

3. Charge the REESS to above 95 percent SOC following one of the methods.
 - a. For a vehicle with a REESS designed to be externally charged, the REESS shall be charged to the highest SOC in accordance with the procedure specified by the manufacturer for normal operation until the charging process is normally terminated.

SOC of REESS after charging _____

- b. For a vehicle with a REESS designed to be charged only by an energy source on the vehicle, the REESS shall be charged to the highest SOC that is achievable with normal operation of the vehicle. The manufacturer shall advise on the vehicle operation mode to achieve this SOC.

SOC of REESS after charging _____

- c. In case that the REESS or REESS sub-system is used as the tested device, the tested device shall be charged to the highest SOC in accordance with the

procedure specified by the manufacturer for normal operation until the charging process is normally terminated. Procedures specified by the manufacturer for manufacturing, service or maintenance may be considered as appropriate if they achieve an equivalent SOC as for that under normal operating conditions. In case that tested device does not control the SOC by itself, the SOC shall be charged to not less than 95 per cent of the maximum normal operation SOC defined by the manufacturer for the specific configuration of the tested device.

SOC of REESS after charging _____

4. Is the REESS being evaluated as a full vehicle with a breakout harness or as a REESS subsystem component evaluation.

Full Vehicle Evaluation _____ REESS subsystem Evaluation _____ (go to 6)

5. For full vehicle testing power up/turn on the vehicle and ensure full operation of the REESS and all subsystems. Document any warning lamps or vehicle faults relating to the electrical power train that are present. Before proceeding, review any warning lamps/faults with the COR and manufacturer to ensure all protection devices are functioning for the REESS before proceeding. Document any visible warning lamps or vehicle faults.

Before proceeding to the next step ensure all equipment is capable of High current level that can be generated during testing!

6. Using the manufacture provided breakout harness that will be installed to the REESS, connect one lead to each side of the short circuit contactor. Using a milliohm meter, measure the total resistance of the equipment used for creating the short circuit. Record the value below. The measured resistance value shall not exceed 5mΩ.

Resistance value for breakout harness and short circuit contactor _____ mΩ

7. Install the breakout harness following directions provided by the manufacturer.
8. Install temperature probes on the case of the REESS or directly on the inside the REESS and document REESS starting temperature.

REESS starting temperature _____

9. For full vehicle short circuit evaluations, perform an isolation resistance evaluation (refer to section 5.1.1.2.4 step 5) to determine electrical isolation value. The value shall not be less than 100 Ω/V.

Electrical Isolation Value _____

10. Using proper personal protective equipment (PPE) and cautionary measures, start recording time and close the contactor to begin the short circuit evaluation.
11. Continuously monitor the current across the short circuit contactor. Continue short circuit evaluation until current is no longer present or Step 12 has been satisfied.
 - a. Current is present _____ (go to step 12)
 - b. Current is no longer present _____ (go to step 13)

12. Record the temperature every 5 minutes from the temperature probe and document the measurements. Continue the short circuit for 1 hour after the temperature probe on the REESS has stabilized with a temperature change of less than 4 °C for a 2-hour period. Once a stabilized temperature has been reached open the short circuit contactor.
13. Once termination of the short circuit contactor is complete, perform a standard cycle, if allowed by the tested device, on the battery following the procedures in Appendix C. Do not replace any fuse that opened during the short circuit to perform the standard cycle.
14. Document the stop SOC or voltage after completion of discharge and charge.
 - SOC or Voltage level when discharge stopped _____
 - SOC or Voltage level when charging stopped _____
15. After charging is completed, allow the REESS to soak for 1 hour at 20 ± 10 °C. Continue to observe REESS for electrolyte leakage, rupture, venting, fire, or explosion.
16. For full vehicle short circuit evaluations, perform an isolation resistance evaluation (refer to Appendix D) to determine electrical isolation value. The value shall not be less than 100 Ω/V.
 - Electrical Isolation Value _____

2.2.7. (5.4.6) Over-charge protection

Review the owner’s manual or manufacturer-provided information to determine the median state of charge (SOC) of the vehicle. Adjust the SOC of the vehicle to +/- 10 percent from the median SOC. Adjust the SOC by charging using the recommended charging practice or discharging by normal operation conditions. For vehicle-based testing with on-board energy conversion systems (internal combustion engine, fuel cell, etc.), verify that the fuel system has sufficient supply to allow operation of the energy conversion system.

REESS SOC _____ Fuel system supply _____

Soak the test vehicle or the REESS (where applicable) at 20 ± 10 °C for 4 hours.

Check Sheet:

For vehicle base evaluations power up/turn on the vehicle and verify functionality of the electric power train system.

Review the owner’s manual or manufacturer’s provided information and work with the COR to determine which method of evaluation will be performed.

- _____ Charge by Vehicle Operation
- _____ Charge by External Electricity Supply (vehicle-based test)
- _____ Charge by Connecting Breakout Harness
- _____ Charge by External Electricity Supply (component-based test)

Charge by Connecting Breakout Harness

1. Create a safety perimeter surrounding the vehicle that provides adequate space/protection against a thermal event.
2. Using the manufacturer's recommended method, attach the breakout harness to the REESS. Document the attachment points and cable routing with photographs
3. Install temperature probes on the case of the REESS or directly inside on the REESS as recommended by the manufacturer. Temperature measurements may be obtained through communication with the REESS control module if a method is supplied by the manufacturer. . Document locations with photographs.
4. Review the manufacturers supplied information to identify if the vehicle has an over-charge protection system.

Yes _____ No _____

5. Using the manufacturer's supplied information define the constant current level, constant voltage level combination used to charge the vehicle.

Maximum constant current or constant voltage charge limit _____

6. The testing current/voltage maximum limit should be 10 percent higher than the maximum current/voltage limit supplied by the manufacturer.

Testing current/voltage limit _____

7. Setup a real-time camera (30fps) to document the viewable REESS during the evaluation period.
8. Record data from each temperature probe in one minute intervals from the application of current/voltage to the completion of the evaluation. If possible have the temperature display in the real-time camera view.

Starting temperature _____

9. Record the start time when current/voltage is applied. If possible have a timer viewable in the real-time camera view.

Starting time _____

10. Apply test current/voltage.

11. Does the REESS over-charge protection control terminate the charge of current/voltage?

Yes _____ (go to step 13) No _____

12. Is the temperature of the probes \leq to 10 °C above maximum operating temperature as specified by the manufacturer?

Yes _____ No _____ (go to step 13)

13. Continue to apply current/voltage for 12 hours or until the conditions in step 11 or 12 are fulfilled.

14. If allowed by the tested device use the connected break out harness to apply a standard cycle as described in Appendix C.

15. Observe the REESS for any evidence of electrolyte leakage, rupture, venting, fire, or explosion. Document any suspected areas with photographs and real-time video.

2.2.8. (5.4.7) Over-discharge protection

Review the owner’s manual or manufacturer’s provided information to determine the nominal SOC of the REESS and the open circuit voltage level that corresponds to 25 percent of the nominal state of charge. Adjust the SOC of the vehicle to +3 percent or following the manufacturer’s recommendation from the lowest normal operating range of the SOC. Adjust the SOC by charging using the recommended charging practice or discharging by normal operating conditions. For vehicle-based testing with on-board energy conversion systems (e.g. internal combustion engine, fuel cell, etc.) reduce the amount of fuel supply to a level where active driving mode is permitted.

Nominal SOC _____ 25% of Working Voltage _____ V
 Fuel system supply level _____

Soak the test vehicle or REESS if component level test the REESS at 20 ±10 °C for 4 hours.

Check Sheet:

1. For vehicle-based evaluations, power up/turn on the vehicle and verify functionality of the electric power train system.
2. Review the owner’s manual or manufacturer-provided information and determine which method of evaluation will be performed by consulting with the COR.
 _____ Discharge by vehicle driving operation
 _____ Discharge by auxiliary electrical equipment (vehicle-based test)
 _____ Discharge of REESS using discharge resistor (vehicle-based test)
 _____ Discharge by external equipment (component-based test)

Discharge of REESS using discharge resistor (vehicle-based test).

3. Create a safety perimeter surrounding the vehicle that provides adequate space/protection in case of a thermal event.
4. Using the manufacturer’s recommended method attach the discharge resistor to the REESS. Document the attachment points and routing of all cables with photographs.
5. Install temperature probes near each terminal where the breakout harness attaches to the REESS and the approximate center of the REESS external case. Document locations with photographs.
6. Review the manufacturer-supplied information to identify if the vehicle has an over-discharge protection system.
 Yes _____ No _____
7. Using the manufacturer’s supplied information define the normal operating discharge rate.

Normal operating discharge rate _____

8. Set the testing equipment or discharge resistor to discharge the REESS at the normal operating discharge rate.
 Test Equipment discharge rate _____ Discharge resistor used _____ Ω
9. Setup a real-time camera (30fps) to document the viewable REESS during the evaluation period.
10. Record data from each temperature probe in one minute intervals from the application of current/voltage to the completion of the evaluation. If possible have the temperature display in the real-time camera view.
 Starting temperature _____
11. Record the initial start time when discharge current is applied. If possible have a timer viewable in the real-time camera view.
 Starting time _____
12. Record pre-test voltage of REESS.
 Pre-Test voltage level _____
13. Using manufactures recommendation close contactors and apply test discharge current.
 For vehicles with an over-discharge protection system:
 - a. Did the REESS discharge protection control terminate the discharge current?
 Yes _____ (go to step 15) No _____
 - b. Continue to apply the discharge current.
 - c. Is the temperature differential ≤ 4 °C for a 2-hour period?
 Yes _____ (go to step 15) No _____
 - d. Continue to apply discharge current until the temperature differential is ≤ 4 °C change for a 2-hour period or the voltage level of the REESS is at 25 percent of its nominal voltage. Document temperature, voltage level and time of termination.
14. Using the connected break out harness apply a standard cycle as described in Appendix C.
 Observe the REESS for any evidence of electrolyte leakage, rupture, venting, fire, or explosion. Document with photographs and real-time video any suspected areas.
15. Perform an isolation resistance measurement following Appendix B using the manufactures recommended locations for the REESS. Isolation resistance must be ≥ 100 Ω/V .

2.2.9. (5.4.8) Over-temperature protection

Review the manufacturer's provided information to determine the recommended discharge rate that will increase the temperature of the REESS cells as rapidly as possible in the range of normal operation of the vehicle. Adjust the state of charge (SOC) of the vehicle to the recommended starting level or if no information is available 95 ± 5 percent SOC. Adjust the SOC by charging using the recommended charging practice or discharge by normal operation conditions. For vehicle-based testing with on-board energy conversion systems (internal combustion engine, fuel cell, etc.) verify that the fuel system has sufficient supply to allow operation of the energy conversion system for the 3 hours of testing.

REESS SOC _____ Fuel system supply _____

Check Sheet:

1. Manufacturer's defined discharge - charge specification.
Discharge method rate and time _____
Charge method rate and time _____
2. For vehicle-based evaluations, power up/turn on the vehicle and verify the functionality of the electric power train system.
3. Determine, in consultation with the COR which method of over temperature evaluation will be performed.
_____ Complete REESS
_____ Complete Vehicle

Over-temperature protection using a complete vehicle.

1. Review the information provided by the manufacturer and disable the REESS cooling system or remove the maximum amount of coolant from the REESS system that will significantly reduce its operation.
Cooling system disabled _____ Amount of coolant removed _____
2. Following the manufacturer's recommendation, install temperature probes inside the REESS in the proximity of the cells. Document, with photographs, the location of each probe. If the vehicle is equipped with REESS temperature sensors, verify operation and temperature sensor reading at ambient temperature.
3. Follow the manufacturer's recommendation for installing a break out harness for charging using an external power supply if the vehicle is capable of external charging. Follow the manufacturer's recommendation for charge current or voltage.
Charge Current _____ Charge Voltage _____
4. Soak the test vehicle at $40-45$ °C for a minimum of 6 hours.
5. Verify REESS temperature is 42 ± 5 °C before proceeding.
6. Install the vehicle on a chassis dynamometer and place the vehicle in driving mode.
7. Setup a real-time camera (30 fps) to document the viewable REESS during the evaluation period.

- Record the temperature from the REESS temperature probes/sensors in one minute intervals from the application of discharge – charge cycle to the completion of the evaluation. If possible, have the temperature display in the real-time camera view.

Starting temperature _____

- Create a safety perimeter surrounding the vehicle that provides adequate space/protection against a thermal event.
- Perform the manufacturer’s outlined discharge – charge cycle until one of the following occurs.
 - Vehicle terminates drive (discharge – charge) cycle
 - Temperature of REESS does not vary by 4 °C over a 2-hour period
 - Any evidence of electrolyte leakage, rupture, venting, fire, or explosion
- Upon completion of the discharge – charge cycle measure the vehicles electrical isolation resistance following Appendix D. The electrical isolation value must be $\geq 100 \Omega/V$.

2.2.10. (5.4.9) Over-current protection

Review the owner’s manual or manufacturer’s provided information to determine the median SOC of the vehicle. If necessary, adjust the SOC of the vehicle to ± 10 percent the median SOC. Adjust the SOC by charging using the recommended charging practice or discharging by normal operation.

REESS SOC _____

Review the manufacturer’s provided information to determine the overcurrent level and maximum voltage that can be applied.

Over-current level _____ Maximum Voltage _____

Soak the test vehicle or, if a component level test, the REESS at 20 ± 10 °C for 4 hours.

Check Sheet:

- For vehicle-based evaluations, power up/turn on the vehicle and verify functionality of the electric power train system.
- Determine, in consultation with COR, which method of evaluation will be performed.

_____ Over-current during charging by external electricity supply

_____ Over-current during charging using breakout harness

Over-current during charging using breakout harness.

- During the entire evaluation process, observe the REESS for any evidence of electrolyte leakage, rupture, venting, fire, or explosion. If any of these signs are present stop the evaluation and document with photographs and real-time video all suspected areas.
- Create a safety perimeter surrounding the vehicle that provides adequate space/protection against a thermal event.

3. Using the manufacturer's recommended method attach the breakout harness to the traction side of the REESS. Document the attachment points and routing of all cables with photographs.
4. Install temperature probes near each terminal on the REESS where the brake out harness attaches and approximately at the external center of the REESS case. Document locations with photographs.
5. Using the manufacturer's supplied information, define the highest normal charge current and the overcurrent level for the vehicle being tested.

Highest Normal charge current _____ Over-current level _____

6. Attach the breakout harness to the electrical supply equipment that will supply the current for the evaluation.
7. Setup a real-time camera (30fps) to document the viewable REESS during the evaluation period.
8. Record each temperature probe from the application of current to the completion of the evaluation in 1 minute intervals. If possible have the temperature display in the real-time camera view.

Starting temperature _____

9. Record the start time when current/voltage is applied. If possible, have a timer viewable in the real-time camera view.

Starting time _____

10. Start the real-time camera, begin recording time and apply highest normal charge current to the vehicle.
11. Over the course of 5 seconds, increase the charge current from the highest normal charge current to the overcurrent level and hold at this current.

12. Did the vehicles overcurrent protection terminate the charging?

Yes _____ (go to step 14) No _____

13. Continue to apply overcurrent level until the temperature differential ≤ 4 °C change for the 2-hour period.
14. Using the connected break out harness apply a standard cycle as described in Appendix C if not prohibited by the vehicle controls.

Observe the REESS for any evidence of electrolyte leakage, rupture, venting, fire, or explosion. Document with photographs and real-time video any suspected areas.

2.2.11. Appendix A: Probe inspection procedures

Protection Degree IPXXD:

1. Measure voltage difference between HV location and electrical chassis:
 - a. Power up the vehicle according to the vehicle owner's manual or manufacturer-supplied information and verify the vehicle is in "ready mode."

IMPORTANT: Use caution throughout the direct contact procedure and assume high voltage is present in the vehicle.
 - b. Connect one lead of a multimeter with a high resistance (10 M Ω) to the electrical chassis and the other lead to the IPXXD probe.
 - i. Probe each HV location with 1 ± 10 percent N of force until the probe contacts a HV part or until the probe cannot be pushed further. The stop face should not penetrate the electric protective barrier (EPB).
 - ii. If the probe partly or fully penetrates the EPB, probe the area in every possible orientation.
 - iii. Document all voltages measured in Table 3.
 - c. If all voltages measured are less than 60V DC or 30V AC, **inspection complete: vehicle meets IPXXD protection.**
 - d. If any voltages measured are greater than or equal to 60V DC or 30V AC, high voltage is present: continue to part 2.
2. Inspect for continuity between the HV location and another known HV location:
 - a. Power down the vehicle and HV system
 - b. Connect one lead of a multimeter OR a low voltage supply with a continuity indicator to an exposed HV location and the other lead to the IPXXD probe.
 - i. Probe each location from step 1.d. that has HV present.
 1. IMPORTANT: Before inspection, protect the area surrounding each location from step 1.d. that has HV present to prevent the probe from shorting HV to the vehicle chassis.
 2. Probe each location with 1 ± 10 percent N of force until the probe contacts a HV part or until the probe cannot be pushed further. Do not allow the stop face to fully penetrate the EPB.
 3. If the probe partly or fully penetrates the EPB, probe the area from every possible orientation.
 4. Document all indications of continuity in Table 4.
 - ii. If no indication of continuity occurs in step 2.b.i., **inspection complete: vehicle meets IPXXD protection.**
 - iii. If any indication of continuity occurs in step 2.b.i., **inspection complete: vehicle does not meet IPXXD protection.**

Protection Degree IPXXB:

1. Measure voltage difference between HV location and electrical chassis.
 - a. Power up the vehicle according to the vehicle owner's manual or manufacturer-supplied information and verify the vehicle is in "ready mode."

IMPORTANT: Use caution throughout the direct contact procedure and assume high voltage is present in the vehicle.
 - b. Connect one lead of a multimeter with a high resistance (10 M Ω) to the electrical chassis and the other lead to the IPXXB probe.
 - i. Probe each HV location with the IPXXB probe joints in a straightened orientation.
 - ii. Probe the area with 10 \pm 10 percent N until the probe contacts a HV part or until the probe cannot be pushed further. Do not allow the stop face to fully penetrate the EPB.
 - iii. If the probe partly or fully penetrates the EPB, probe the area in every possible orientation with the probe joints in a straightened orientation. Proceed to probe the area in every possible orientation with the probe joints in a bent fashion with each joint bending up to 90 degrees relative to the adjacent joint.
 - iv. Document all voltages measured in the appropriate table (Table 7 or 12).
 - c. If all voltages measured are less than 60V DC or 30V AC, **inspection complete: vehicle meets IPXXB protection.**
 - d. If any voltages measured are greater than or equal to 60V DC or 30V AC, high voltage is present: continue to part 2.
2. Inspect for continuity between the HV location and another known HV location:
 - a. Power down the vehicle and HV system.
 - b. Connect one lead of a multimeter OR a low voltage supply with a continuity indicator to an exposed HV location and the other lead to the IPXXB probe.
 - i. Probe each location from step 1.d. that has HV present.
 1. IMPORTANT: Before inspection, protect the area surrounding each location from step 1.d. that has HV present to prevent the probe from shorting HV to the vehicle chassis.
 2. Probe each location with the IPXXB probe joints in a straightened orientation.
 3. Probe the area with 10 \pm 10 percent N until the probe contacts a HV part or until the probe cannot be pushed further. Do not allow the stop face to fully penetrate the EPB.
 4. If the probe partly or fully penetrates the EPB, probe the area in every possible orientation with the probe joints in a straightened orientation. Proceed to probe the area in every possible orientation

with the probe joints in a bent fashion with each joint bending up to 90 degrees relative to the adjacent joint.

5. Document all indications of continuity in the appropriate table (Table 8 or 13).
 - ii. If no indication of continuity occurs in step 2.b.i., **inspection complete: vehicle meets IPXXB protection.**
 - iii. If any indication of continuity occurs in step 2.b.i., **inspection complete: vehicle does not meet IPXXB protection.**

2.2.12. Appendix B: Resistance evaluations

Resistance Tester Method:

Use a resistance tester with a current flow of at least 0.2 A and a resolution of at least 0.01 Ω for the following measurements. A handheld resistance tester such as a Hioki RM3548 meets the specifications outlined in paragraph 6.1.4.

Measure the resistance between the test location (component or connector) and the electrical chassis.

Measure the resistance between the test location and all other test locations in Table 17 that are within 2.5 m of each other.

Repeat these measurements for all test locations in Table 17 that have not already met protection against indirect contact. Document all resistance measurements in Table 18.

DC Power Supply Method:

Use a DC power supply with a current flow of at least 0.2 A, a voltmeter with a resolution of at least 0.001 V, and an ammeter with a resolution of at least 0.01 A for the following measurements. Connect the DC power supply, voltmeter and ammeter to the test location and the electrical chassis following Figure 2.

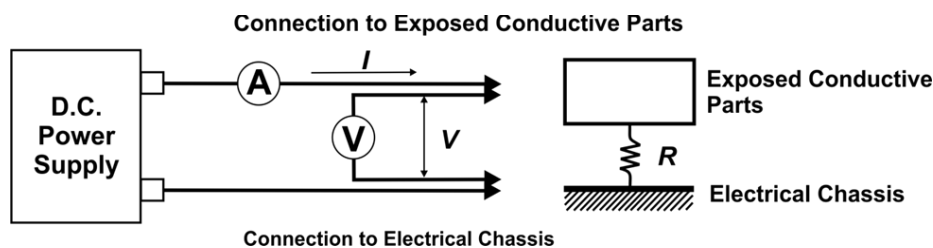

Figure 2

Measure the current “I” and voltage “V” between the test location and the electrical chassis. Calculate the resistance between the test location and the electrical chassis using the following formula.

$$R = V/I$$

Measure the current “I” and voltage “V” between the test location and all other test locations in Table 17 that are within 2.5 m of each other. Calculate the resistance between the test locations using the following formula.

$$R = V/I$$

Repeat these measurements for all test locations in Table 17 that have not already met protection against indirect contact. Document all “I,” “V,” and “R” measurements and calculations in Table 19.

2.2.13. Appendix C: Standard cycle

Information provided by the manufacturer shall include discharge procedure, charge procedure

For cases where no information is provided by the manufacture the following will serve as a discharge/charge cycle.

1. Verify the ambient temperature is 20 ± 10 °C.
2. Following the manufacturers recommendation on establishing a connection to the REESS.
3. For discharging a REESS or RESSS subsystem, discharge the REESS at a rate specified by the manufacturer or at a rate equal to the REESS amp-hour rating (1C).
- 3a. For discharging using a full vehicle, the discharge procedure will be defined by the manufacturer and the termination limit will be according to the vehicle controls.
4. Continue to discharge the REESS until the discharge limit specified by the manufacturer is reached.
5. Upon completion of the discharge, allow the REESS to rest for a minimum of 15 minutes.
6. Begin charging the REESS following the manufacturer’s recommendation. For cases with no manufacturer provided recommendation of charge current use a rate equal to 1/3 the amp-hour rating (1/3C) of the REESS.
7. Continue charging the REESS until normally terminated.
8. Verify charge termination has met GTR No. 20 (6.2.1.2.2).

2.2.14. Appendix D: Isolation resistance

1. For the following measurements ensure the voltmeter being used has an internal resistance of at least 10 MΩ.
2. Measure and record the high-voltage bus voltage (Vb) as shown in Figure 2. Vb must be equal to or greater than the nominal operating voltage of the REESS and/or energy conversion system as specified by the vehicle manufacturer.

Figure 2
Measurement of V_b , V_1 , V_2

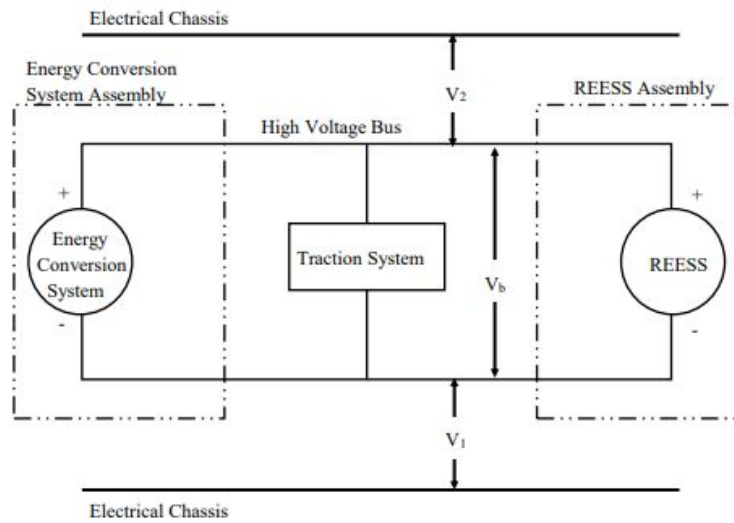

3. Measure and record the voltage (V_1) between the negative side of the high-voltage bus and the electrical chassis (see Figure 2).
4. Measure and record the voltage (V_2) between the positive side of the high-voltage bus and the electrical chassis (see Figure 2).
5. If V_1 is greater than or equal to V_2 , a standard known resistance (R_o) is inserted between the negative side of the high-voltage bus and the electrical chassis. With R_o installed, measure the voltage (V_1') between the negative side of the high-voltage bus and the electrical chassis (see Figure 3).

Figure 3
Measurement of V_1'

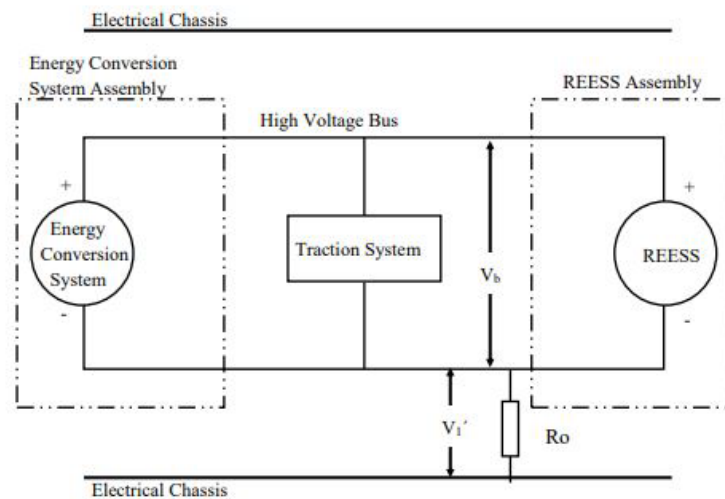

6. Calculate the electrical isolation (R_i) according to the following formula.

$$R_i = R_o \cdot (V_b/V_1' - V_b/V_1) \text{ or } R_i = R_o \cdot V_b \cdot (1/V_1' - 1/V_1)$$

- If V_2 is greater than or equal to V_1 , a standard known resistance (R_o) is inserted between the positive side of the high-voltage bus and the electrical chassis. With R_o installed, measure the voltage (V_2') between the positive side of the high-voltage bus and the electrical chassis (see Figure 4).

Figure 4
Measurement of V_2'

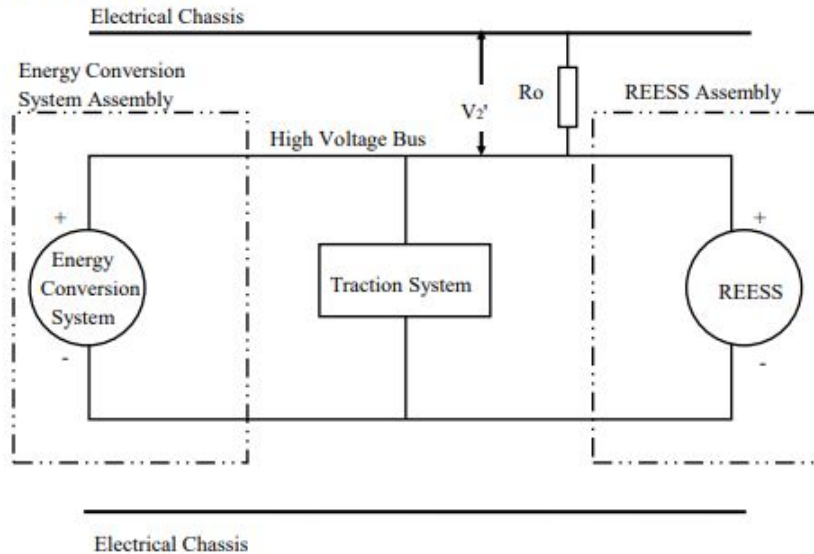

- Calculate the electrical isolation (R_i) according to the following formula.

$$R_i = R_o \cdot (V_b/V_2' - V_b/V_2) \text{ or } R_i = R_o \cdot V_b \cdot (1/V_2' - 1/V_2)$$
- Divide the electrical isolation value R_i (in Ω) by the working voltage of the high-voltage bus (in V) to calculate the isolation resistance (in Ω/V).
- Compare the isolation resistance value calculated in step 9 to the values in paragraphs 5.1.1.2.4.1. and 5.1.1.2.4.2. to determine if the vehicle meets the requirements.

Note 1: The standard known resistance R_o in Ω should be the value of the minimum required isolation resistance in Ω/V multiplied by the working voltage of the vehicle ± 20 percent in V. R_o is not required to be precisely this value because the equations are valid for any R_o ; however, a R_o value in this range will provide good resolution for the voltage measurements.

3. Validation Results, Discussion, and Feedback

This test report presents the results of GTR testing and procedure validation for a model year 2019 Chevrolet Bolt with DC fast charge capability following the procedures outlined in this report. The subject vehicle is equipped with a 60kW lithium-ion battery pack. Additional details on the vehicle and battery pack were recorded based on information typically supplied by manufacturers to support FMVSS 305 requirements.



Figure 1: 2019 Chevrolet Bolt

TEST VEHICLE INFORMATION

Year/Make/Model/Body Style	2019 Chevrolet Bolt EV LT 5-Door Hatchback
Color	Cajun Red
Odometer Reading	61km/44mi

DATA FROM CERTIFICATION LABEL ELECTRIC VEHICLE PROPULSION SYSTEM

Manufactured By	GENERAL MOTORS LLC	GVWR (kg)	2024
Date of Manufacture	01/19	GAWR Front (kg)	1016
VIN:	1G1FY6S02K4122883	GAWR Rear (kg)	1008

Type of Electric Vehicle (Electric/Hybrid):	Electric
Electric Energy Storage/Device:	Lithium-Ion (Li-Ion) Battery
Nominal Voltage (V):	348 V
Is This Vehicle Equipped With an Automatic Propulsion Battery Disconnect?	Yes
Physical Location of the Automatic Propulsion Battery Disconnect:	Physically Contained In the Energy Storage System.
Auxiliary Battery Type:	12 V Absorbent Glass Mat

ELECTRIC ENERGY STORAGE CONVERSION/DEVICE SYSTEM DATA

Electrolyte Fluid Type:	1 Molar Concentration of a Lithium Salt, Lithium Hexafluorophosphate (LiPF ₆), EC/EMC (vol. 3:7)	
Electrolyte Fluid Specific Gravity:	1.2 (g/mL)	
Electrolyte Kinematic Viscosity:	4.7 (cP)	
Electrolyte Fluid Color:	Transparent (APHA <50)	
Electric Energy Storage/Conversion System Coolant Type, Color, Specific Gravity (if applicable):	50/50 Deionized Water (clear) Dexcool Mix (pale orange)	
Location of Battery Modules:		Inside Passenger Compartment
	X	Outside Passenger Compartment
	The High-Voltage Battery Is Mounted Below the Occupant Compartment.	

ELECTRIC ENERGY STORAGE CONVERSION/DEVICE STATE OF CHARGE

<i>For all battery types:</i>	
Voltage range corresponding to useable energy of the battery:	
Minimum State of Charge:	285 V
Maximum State of Charge:	400 V
95 Percent of Maximum State of Charge:	380 V

3.1. Protection Against Direct Contact (5.1.1.1)

3.1.1. Procedure feedback and revisions

GTR No. 20 outlines an exemption for connectors that are provided with a locking mechanism (at least two distinct actions are needed to separate the connector from its mating component). This exemption and clarification are included as a reference in the draft test procedure. The exemption text has been incorporated directly into the revised laboratory test procedure as a note in the relevant section for clarity.

The IPXXD tool that was available for purchase by the test lab at the time of testing, shown in Figure 2 below, is not equipped with an electrical lead. The only method available for measuring voltage from the probe would be direct connection to the test surface, which would alter the specified dimensions of the probe. An updated probe, Model TRP-02D, is currently available from ED&D with a continuity check in the handle.



Figure 2: IPXXD Test Probe

The original procedure does not include an exemption for 120 VAC power outlets, subjecting them to the IPXXD probe voltage and continuity requirements of the test procedure. These power outlets may already be regulated by other requirements and an exemption can be included in the test procedure to avoid redundancy.

3.1.2. Validation testing results and discussion

The 2019 Chevrolet Bolt was visually inspected to identify any accessible components and connectors located in the passenger and luggage compartments that could contain high voltage. Any parts or components that could be removed without the use of tools were separated from the vehicle. The rear bench seat in the passenger compartment is removeable, exposing the Manual Service Disconnect as shown in Figure 5. The luggage compartment is displayed in Figure 4 after carpeting and trim were removed during the inspection. No high-voltage locations were identified during the visual inspection of the passenger and luggage compartments that required IPXXD protection.

Areas other than the passenger and luggage compartment were visually inspected for high-voltage components and connectors. All of the connectors identified met the exemption criteria of GTR No. 20 Section 5.1.1.1, requiring at least two distinct actions to separate the connector. No high-voltage locations were identified that required IPXXB protection.

The manual service disconnect is located under the rear passenger seat pan, is accessible without the use of tools, and can be removed without tools. The manual safety disconnect has eight connection terminals, evaluated with the IPXXB probe and no voltage was present at any location.

SERVICE DISCONNECT

<u>HV Location</u>	<u>Voltage</u>	<u>Continuity</u>
Manual Safety Disconnect Connection Terminal #1	0.0 V	
Manual Safety Disconnect Connection Terminal #2	0.0 V	
Manual Safety Disconnect Connection Terminal #3	0.0 V	
Manual Safety Disconnect Connection Terminal #4	0.0 V	
Manual Safety Disconnect Connection Terminal #5	0.0 V	
Manual Safety Disconnect Connection Terminal #6	0.0 V	
Manual Safety Disconnect Connection Terminal #7	0.0 V	
Manual Safety Disconnect Connection Terminal #8	0.0 V	

All identified connectors contained at least one orange component and all of the high-voltage wires inspected had an orange cover. Four major high-voltage components were identified during the visual inspection: high-power distribution module (HPDM), accessory power module (APM), single-power inverter module (SPIM), and onboard charging module (OBCM). All four components were marked with the appropriate figure defined in the GTR and draft test procedure. Figure 6 displays the location of these four major components in the front compartment of the vehicle.

MARKINGS

<u>HV Location</u>	<u>Marking</u>	<u>Orange Cover</u>
High-Power Distribution Module (HPDM)	X	
Accessory Power Module (APM)	X	
Single-Power Inverter Module (SPIM)	X	
Onboard Charging Module (OBCM)	X	
HPDM to Cabin Heater Cable		X
HPDM to Battery Coolant Heater Cable		X
HPDM to APM Cable		X
HPDM to SPIM Cable		X
HPDM to Air Conditioning Compressor Module Cable		X
HPDM to OBCM Cable		X
HPDM to Fast-Charging Port Cable		X
HPDM to REESS – Charging Cable		X
HPDM to REESS Cable		X
OBCM to Charging Port Cable		X
SPIM to Motor Cables (Qty 3)		X



Figure 3: Vehicle Occupant Compartment



Figure 4: Vehicle Luggage Compartment



Figure 5: Vehicle Manual Service Disconnect

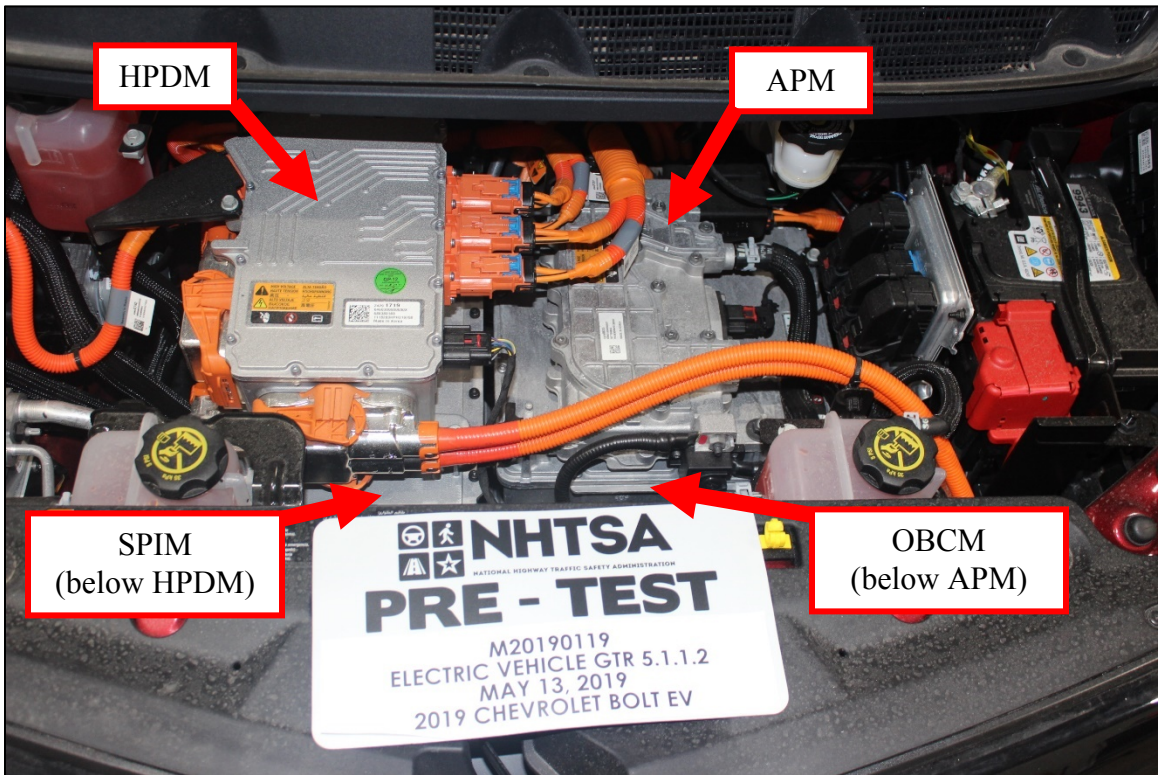

Figure 6: Vehicle Front Compartment

3.2. Protection Against Indirect Contact (5.1.1.2)

3.2.1. Procedure feedback and revisions

The Hioki RM3548 multimeter is identified in Appendix B of the draft test procedure as a tool that meets the requirements of the GTR. Upon inspection, it was noted that the maximum distance between the leads of the multimeter is 2.2 meters. The test procedure requires measurements at locations up to 2.5 meters apart. A different model, the Hioki RM3544 multimeter, is a bench-top model that provides leads that can measure points approximately 2.7 meters apart, according to the manufacturer’s specifications.

3.2.2. Validation testing results and discussion

The 2019 Chevrolet Bolt was visually inspected to identify any HV locations with exposed conductive parts on the vehicle’s interior and exterior. The grounding connection method for each component identified was recorded and the resistance was measured across each location and the chassis of the vehicle. The resistance between all HV locations in 2.5 meters of each other was measured and recorded. The Hioki RM3548 multimeter and resistance tester method from Appendix B of the draft test procedure was used for all resistance measurements. All identified locations were accessible with the Hioki RM3548 leads.

PROTECTION AGAINST INDIRECT CONTACT

<u>HV Location</u>	<u>Connection</u>	<u>Resistance</u>
High Power Distribution Module (HPDM)	Bolts	0.00 Ω
Single Power Inverter Module (SPIM)	Bolts	0.00 Ω
Accessory Power Module (APM)	Bolts	0.00 Ω
Onboard Charging Module (OBCM)	Bolts	0.00 Ω

<u>HV Location 1</u>	<u>HV Location 2</u>	<u>Resistance</u>
HPDM	SPIM	0.00 Ω
HPDM	APM	0.00 Ω
HPDM	OBCM	0.00 Ω
SPIM	APM	0.00 Ω
SPIM	OBCM	0.00 Ω
APM	OBCM	0.00 Ω

ISOLATION RESISTANCE – DC BUS

<u>Measurement</u>	<u>Value</u>	<u>Isolation</u>
Vb	382.2 V	
V1	187.8 V	1,527,807 Ω
V2	188.1 V	1,533,776 Ω
V1'	34.7 V	
V2'	34.6 V	
Ro	173,000 Ω	
Working Voltage	400 V	3,820 Ω /V

3.3. Functional Safety (5.1.2)

3.3.1. Procedure feedback and revisions

Electric vehicles may produce an exterior audio signal for the purpose of alerting pedestrians when the vehicle is in “active driving possible mode.” Exterior audio signals were not included in the validations conducted for this report.

The draft test procedure for GTR 5.1.2.2 evaluates two potential sequences for the driver leaving the vehicle while it is still in active driving possible mode. The vehicle is placed in an active driving possible mode and then the following two sequences are outlined.

1. Release the brake and open the door
2. Open the door and release the brake

After a review of the draft test procedure an additional sequence was identified: Open the door, place the vehicle in active driving possible mode, and then release the brake (if applicable). The GTR No. 20 5.1.2.2 requirement states that when leaving the vehicle, the driver shall be informed by a signal if the vehicle is still in active driving possible mode. All three scenarios above meet the criteria of GTR 5.1.2.2 and additional scenarios may exist that were not identified in the validations testing.

3.3.2. Validation testing results and discussion

5.1.1.1 Momentary indication when placed in active driving mode

A real-time camera was placed inside the vehicle to record the instrument cluster while the vehicle was started and placed into all possible active driving modes. The visual and audio indications were recorded and noted for the test report. Figure 7 presents the vehicle instrument cluster during startup, while most of the tell-tale signals are illuminated. The “Vehicle Ready” signal is located toward the bottom right and is represented by the outline of a passenger vehicle with the word ‘READY’ below it, both colored green. A drive direction signal is located at the bottom right corner of the instrument panel in white, which identifies the active driving mode that the vehicle is currently in.



Figure 7: Vehicle Instrument Cluster

<u>Drive Mode Selection</u>	<u>Momentary Indication Description</u>
Startup	Vehicle Ready light illuminates upon startup.
Drive/Forward	Drive direction icon at the bottom right of the instrument cluster changes from “P” to “D.”
Reverse	Drive direction icon at the bottom right of the instrument cluster changes from “P” to “R.”

5.1.1.2 Driver to be informed leaving vehicle

A real-time camera was placed inside the vehicle to record the instrument cluster while the driver attempted to leave the vehicle while still in active driving mode. While following the draft procedure the vehicle responded to any attempts with three actions:

1. The vehicle was removed from active driving mode and placed in Park.
2. A message on the instrument cluster common space informed the driver “Always Shift to Park When Exiting,” shown in Figure 8. This message needed to be dismissed by the driver by pressing the confirmation button (✓) on the steering wheel, and is shown in Figure 8.
3. The parking brake was engaged and a momentary message to the driver appeared on the instrument cluster common space stating that the parking brake was engaged, and then reverted back to the message outlined in item #2. The parking brake tell-tale signal, located at the upper right corner of the instrument cluster, illuminated.



Figure 8: GTR 5.1.2.2 Driver Signal

An additional validation test was performed using the following sequence.

1. Vehicle was placed in “Vehicle Ready” mode
2. Driver’s foot depressed the brake pedal
3. Driver’s door was opened
4. An active drive mode was selected (Drive or Reverse)
5. Driver’s foot released the brake pedal

At the conclusion of this sequence the driver could leave the vehicle while still in active driving mode without any visual or audio signal.

The vehicle met the requirements when evaluated to the draft test procedure, but did not meet the requirements when subjected to the additional evaluation that included similar actions performed in slightly different sequence.

5.1.1.4 Vehicle movement disabled during external charging

The vehicle was delivered with a 1440W AC L1 external charger (part number 24291478), which was used for the validation test. Plum bobs were placed at the front and rear of the vehicle and the initial position of the vehicle was marked on the floor at each location. The charger was connected following the instructions in the owner’s manual provided with the vehicle. A visual signal on the dash confirmed that the vehicle was actively charging. The vehicle was then powered up and placed into each active driving mode possible. The vehicle responded to any attempts with the following messages:

1. “Conditions Not Correct for Shift” was momentarily displayed on the instrument cluster common space, shown in Figure 11.

2. “Charge Cord Connected” was displayed on the instrument cluster common space, shown in Figure 12, and had to be dismissed by the driver by pressing the confirmation button (✓) on the steering wheel.



Figure 9: Vehicle Level 1 (L1) Charger



Figure 10: Vehicle Level 1 (L1) Charger



Figure 11: Momentary Signal to Driver When Selecting Active Drive Mode Possible While External Charging Is Active.



Figure 12: Signal to Driver When Selecting Active Drive Mode Possible While External Charging Is Active.

3.4. Requirements With Regard to Installation and Functionality of REESS in a Vehicle (5.3)

3.4.1. Procedure feedback and revisions

The draft test procedure references materials and information provided by the vehicle manufacturer to satisfy the requirements of GTR 5.3, but no procedure or forms exist for obtaining the appropriate information from the manufacturer. A form was developed and included in the revised laboratory test procedure.

3.4.2. Validation testing results and discussion

The vehicle’s REESS system warnings to the driver consist of text shown in the common space on the instrument cluster, and are therefore not evaluated to the requirements of GTR 5.3.2 and 5.3.3.

5.3.4 Warning in the event of low energy content of REESS

The vehicle warns the driver of low energy content at approximately 10 percent remaining state of charge. A visual message is displayed to the driver in the instrument cluster common space stating “Propulsion Power is Reduced,” the range gauge turns from green to yellow, and the numeric range is replaced with the text “Low.” Figure 13 displays the low energy driver alerts present on the instrument cluster. The infotainment screen also displays a message, providing the driver the option of entering low power mode to conserve energy, and is presented in Figure 14.



Figure 13: Low Energy Warning to the Driver



Figure 14: Low Energy Warning on Infotainment System

3.5. Safety of REESS In-Use (5.4)

3.5.1. Procedure feedback and revisions

Test Information/Methodology

The GTR No. 20 test procedure relies on vehicle manufacturer information for the majority of the “in-use” testing, due to the specific details of each vehicle and REESS system’s design and function. Break out harnesses are required to connect laboratory equipment to the vehicle, and test parameters are defined by the manufacturer for over-charge, over-discharge, over-temperature, and overcurrent testing. For the validation testing conducted in this report it took 14 weeks for the vehicle manufacturer to respond to the test lab’s request for test parameters and break out harnesses. Based on the draft test procedure the test lab provided the request in Figure 15 to the vehicle manufacturer prior to “in-use” testing. Communication continued bi-weekly via telephone conference calls and email to resolve questions or areas of uncertainty by any of the parties.

MGA OEM Information Request to support GTR Evaluations

Battery Specifications

MGA has 2018 Chevrolet Bolt FMVSS 305 Documentation

- Normal operating Range (voltage and SOC) of vehicle
- Maximum Battery Voltage within normal operating range – 400V from MY 2018
- Nominal voltage level - 348V from MY 2018

Evaluation Specific Items

- Current or Voltage limit for charging (6.2.6.3.2.3 (a)). Provide charge profile from 0-100SOC or recommendation for limit cutoff.
- Discharge resistor recommendation if not 1kW 6.2.7.3.2.3 (b)
- Discharge rate for normal operating conditions 6.2.7.3.2.3 (b)
- Directions on how to limit/disable cooling system 6.2.3.2
- CAN support to monitor cell temperature 6.2.8.3.3
- Charge / discharge rate for 6.2.8.4.2
- Internal overheating temperature protection limit (if equipped)
- Break out harness pertaining to sections 6.2.5.3.1 (d), 6.2.6.3.2.3, 6.2.7.3.2.3, 6.2.9.5 (a)

Figure 15: Test Lab Information Request

In order to facilitate communication between the regulatory body, test laboratory, and vehicle manufacturer it is recommended that a procedure is created with the appropriate forms and instructions to ensure the necessary information is supplied to each party. The following list was the minimum information required for testing that was identified through the validation testing conducted in this report. An example of an updated technical information sheet that includes these items is presented in Appendix A of this report.

- Standard Cycle
 - Provide discharge rate and procedure for a standard cycle, including end voltage.
- External Short Circuit
 - Provide a break out harness and installation instructions.
- Over-charge
 - Provide a break out harness and installation instructions.
 - Provide maximum charge current and voltage limit of the tested device.
 - Provide maximum operating temperature of the REESS.
- Over-discharge
 - Provide a break out harness and installation instructions.
 - Provide the maximum discharge rate. Default value is 1 kW.

- Over-temperature
 - Provide a break out harness and installation instructions if charging is required.
 - Provide a procedure for disabling the REESS cooling system to the extent possible while maintaining REESS operation.
 - Provide the charging (if applicable) and driving profile to produce maximum REESS temperatures during the test.
- Over-current
 - Provide a break out harness and installation instructions.
 - Provide the maximum current and voltage of external DC charging equipment, and the maximum normal operating charging current of the external DC charging equipment.
- REESS Temperature Monitoring
 - Provide a procedure for monitoring the temperature of the REESS during testing.

Standard Cycle

GTR No. 20 section 6.2.1.1 states that a standard cycle shall start with a standard discharge and is followed by a standard charge.

For a complete vehicle, the discharge procedure using a dynamometer shall be defined by the manufacturer. The test lab did not have a dynamometer available for use, so normal vehicle operation was used for the standard discharges conducted in this test report. Normal vehicle operation included travel at a speed of 40 mph on a level surface with the cabin environmental controls set to high temperature. A full discharge cycle was completed in approximately 4 hours following this method.

For a full vehicle that can be charged by an external source, a procedure using an external electric power supply shall be defined by the manufacturer. The level 1 charger supplied with the vehicle was used for the standard charges conducted in this test report. A full charge cycle took approximately 72 hours following this method.

There is no provision in the GTR No. 20 for using a break out harness and battery test machine to conduct the standard cycles. Using this equipment would allow the test lab to monitor and record the inputs to the vehicle during the standard cycles.

REESS Temperature Measurement

REESS temperature is monitored in all of the “in-use” tests presented in this report. In an effort to minimize the modifications made to the vehicle prior to testing the test lab requested that the vehicle manufacturer provide the necessary support to monitor the REESS temperature through the internal battery management system.

3.6. External Short Circuit Protection (5.4.5)

3.6.1. Procedure feedback and revisions

The draft test procedure specifies to continuously monitor the current across the short circuit contactor, but does not provide direction on whether to record this data and at what sample rate recording should be done. The short circuit test presents two different types of events that should be captured, an initial pulse immediately after the contactor is closed and a potentially much longer duration of test in the event that the battery management system does not terminate the flow of current from the battery after the short is applied. It may be necessary to capture two sets of current data to ensure that all relevant data is recorded during the test. An event flag in the data sets displaying the status of the contactor would be helpful when reviewing the data.

3.6.2. Validation testing results and discussion (6.2.5)

The manufacturer's breakout harness was connected between the high power distribution module and single power inverter module. The short circuit contactor and associated cabling had a measured resistance of 0.9 mΩ and was equipped with a 30,000 amp shunt. Vehicle battery voltage, current, and temperature values were recorded through the on-board diagnostics port with a Vector VN1610A CAN interface. Voltage across the short circuit contactor shunt was measured at 20,000 samples per second and 1,000 samples per second. The higher sample rate was recorded for 300 seconds to capture the initial pulse when the contactor closed and the lower sample rate was used to monitor the current across the short circuit contactor and determine if the test could be terminated.

The maximum state of charge is 400 V and the short circuit test was conducted at 398 V. The vehicle was soaked at 20 °C for four hours prior to the test. The short circuit test was conducted outdoors with an ambient temperature of 5 °C as a safety precaution.

The short circuit contactor was closed approximately 23 seconds after the data recorders were started. Two current pulses in the range of 200 – 250 amps were recorded about 70 milliseconds apart in the high sample rate data set, shown in Figure 21. The CAN data and 1,000 hertz data logger each only recorded a single current pulse at the time of contact closure. No additional current was observed in any of the data after 70 milliseconds, and the battery voltage value recorded through the diagnostic port measured 0 V after the current pulse. The short circuit contactor was opened after observing no current across the shunt for 30 seconds. Data traces from the test are presented in Figures 18 – 21.

A standard cycle was not possible after the short circuit test, but the vehicle would power on. The instrument cluster stated "Service Vehicle Soon," the service vehicle soon tell-tale was illuminated, and the Vehicle Ready light would not illuminate. No evidence of electrolyte leakage, rupture, venting, fire, or explosion was observed. The vehicle was towed to a dealership for repair, and required replacement of the lever disconnect fuse (MFG Part # 24294004) and relay contactor assembly (MFG Part # 24291633).

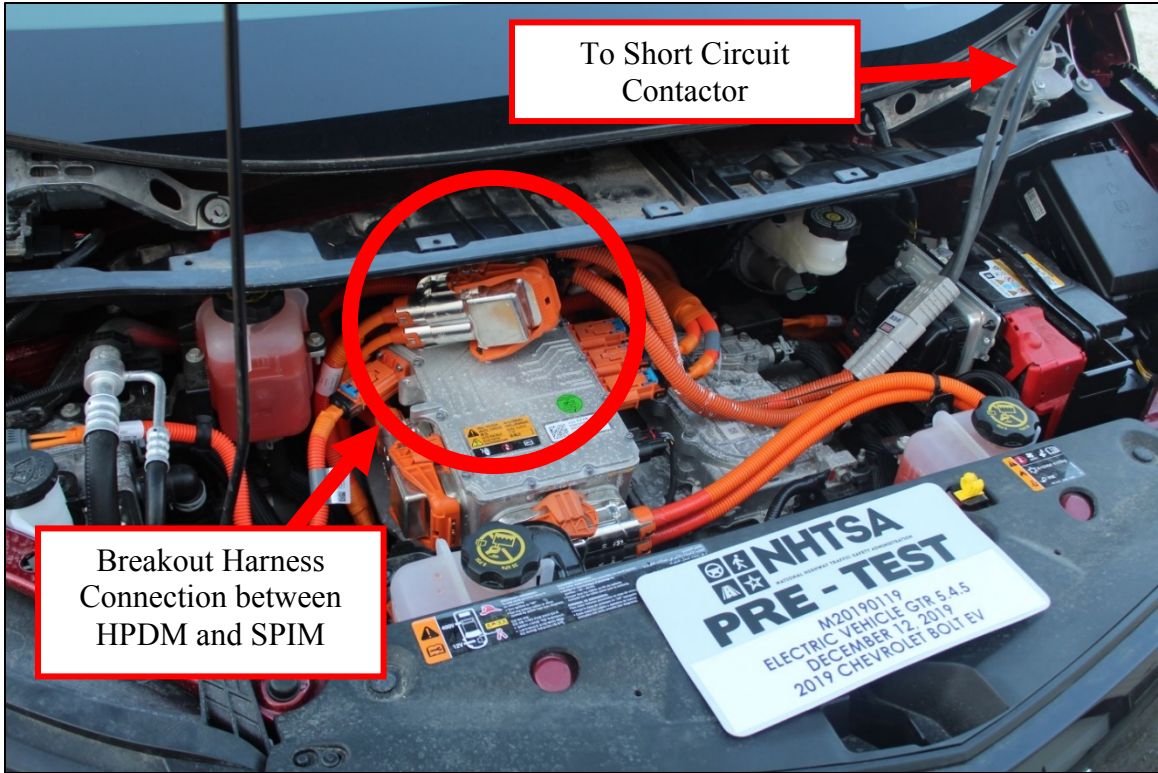

Figure 16: External Short Circuit Breakout Harness

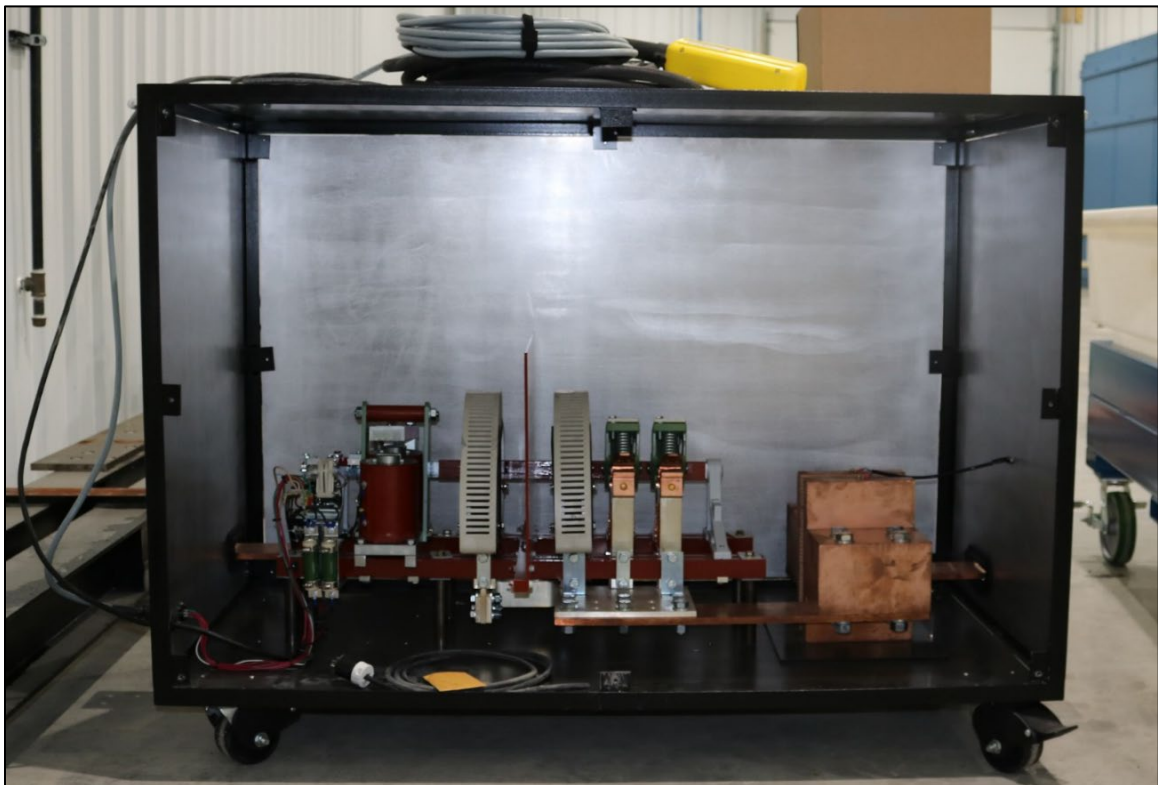

Figure 17: External Short Circuit Contactor

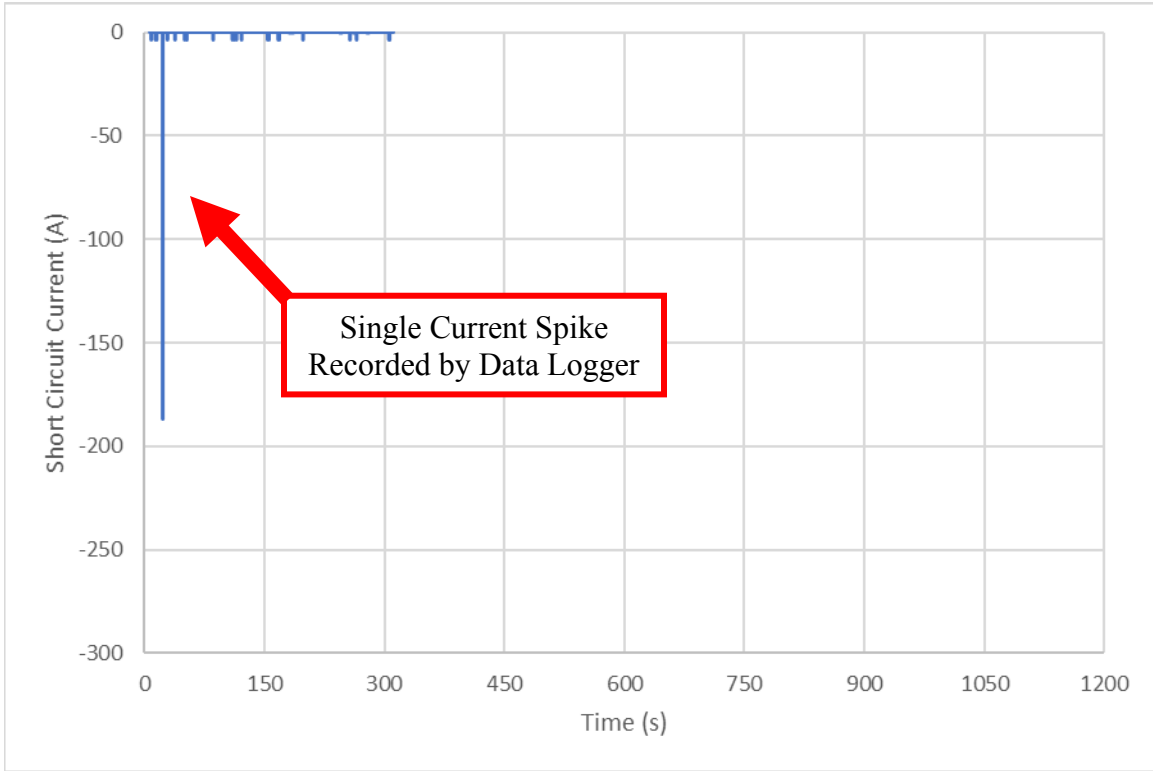

Figure 18: External Short Circuit Test Shunt Current at 1,000 sps

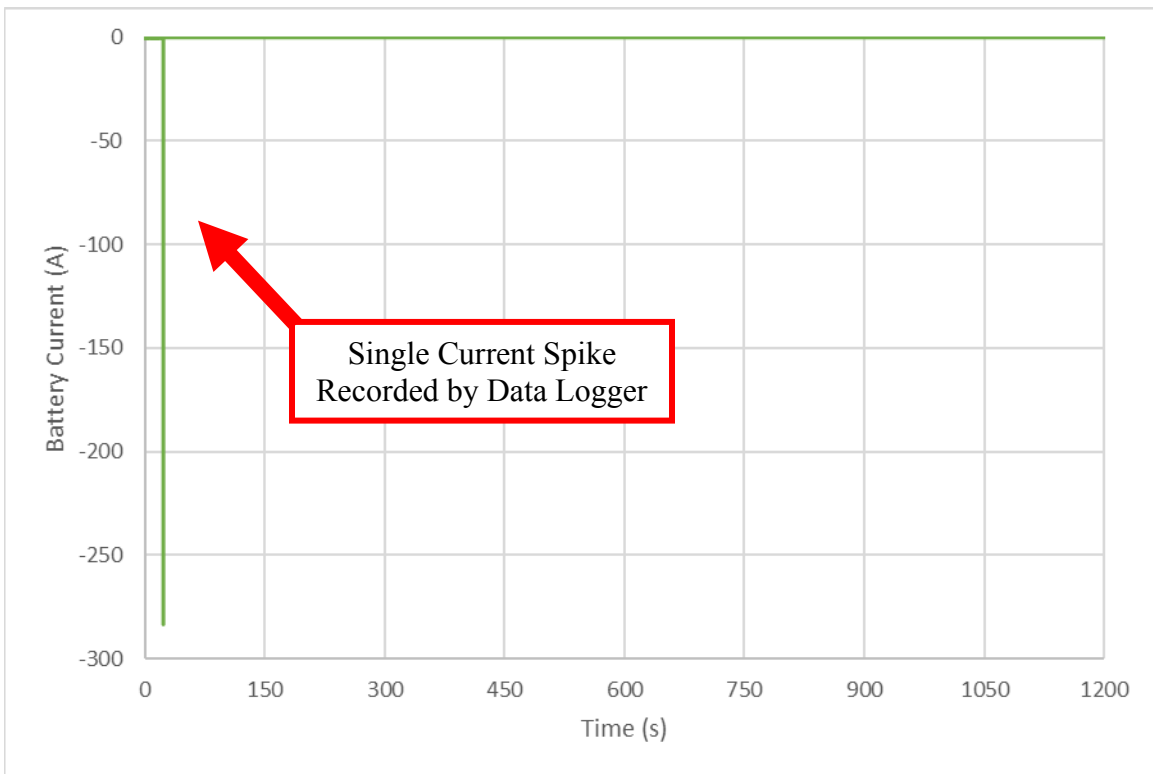

Figure 19: External Short Circuit Test Battery Current

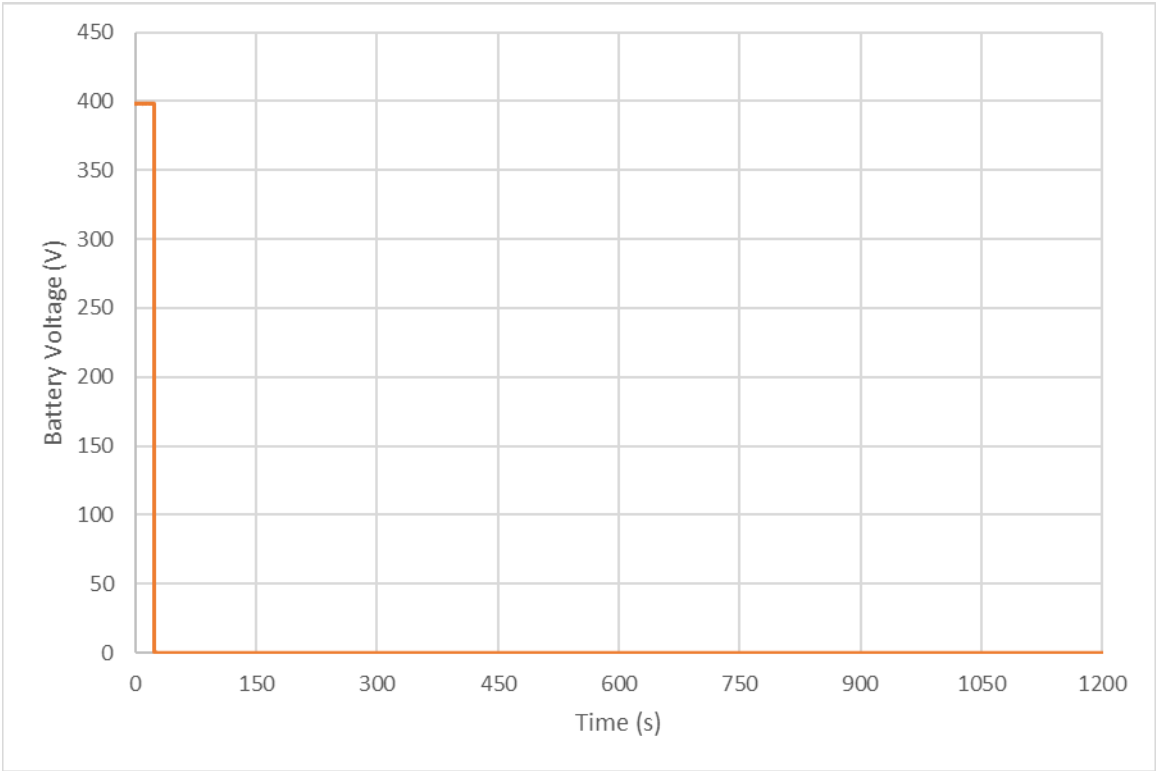

Figure 20: External Short Circuit Test Battery Voltage

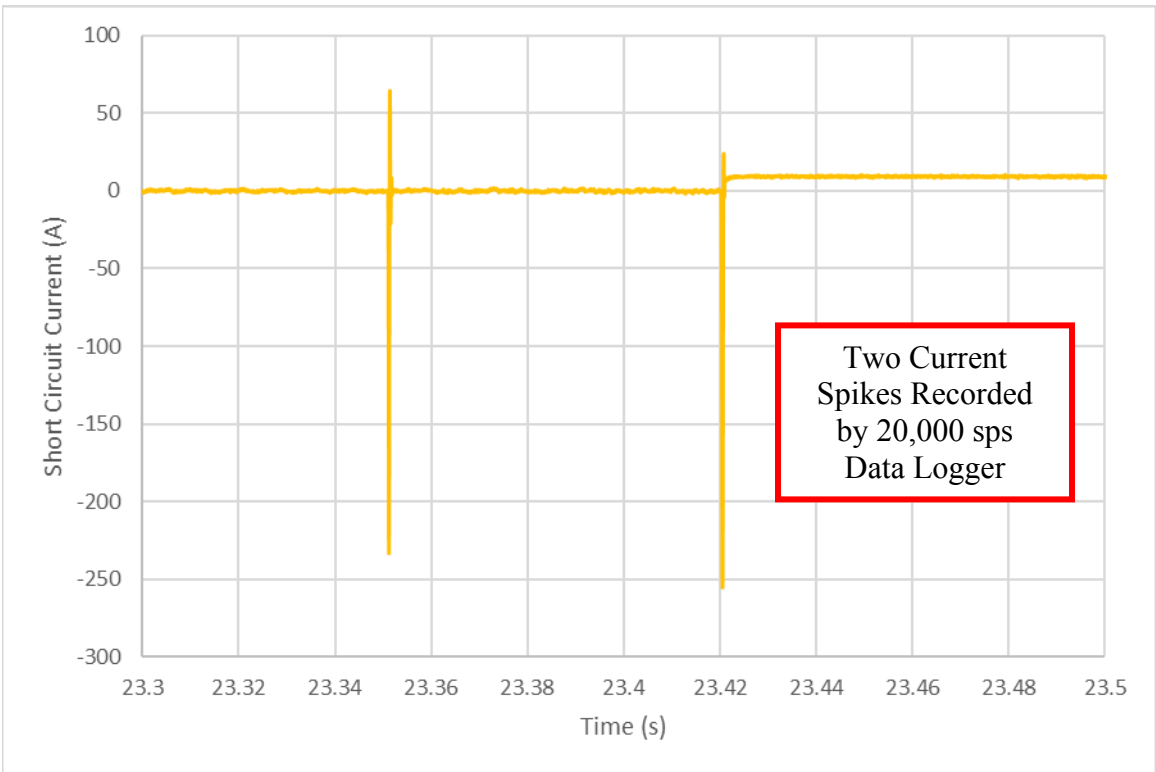

Figure 21: External Short Circuit Test Shunt Current at 20,000 sps

3.7. Over-Charge Protection (5.4.6)

3.7.1. Procedure feedback and revisions

The draft procedure and GTR No. 20 specify that the initial state of charge of the battery should be at the middle of the normal operating range. A high capacity battery and a low maximum current specified by the manufacturer could create a test that requires over 24 hours to complete. For the purpose of the validation testing all parties agreed that a starting voltage of 95 percent maximum state of charge would be appropriate to reduce the total test time in order to facilitate the observation of the test by NHTSA and manufacturer representatives.

Step 10 of the draft procedure was modified to note that charging of the vehicle would continue until either step 11, 12, or 13 occurred. Step 11 was modified to state that the test should proceed to step 14 if the battery management system terminated charging. Finally, step 15 was modified to include a duration of 1 hour for the observation period as specified in the GTR.

The GTR No. 20 specifies for high-voltage REESS an isolation measurement after the test shall not be less than 100 Ω/V . This measurement is not included in the draft procedure and was not performed in the validation testing.

3.7.2. Validation testing results and discussion (6.2.6)

The manufacturer's breakout harness was connected between the high power distribution module and onboard charging module. The manufacturer's test method used the supplied Level 1 AC charger in conjunction with the NHR Battery Test System to produce the over-charge. The Level 1 AC charger supplied AC current to the onboard charging module. The onboard charging module converted the AC current to DC current and then passed it through the breakout harness to the high power distribution module. The NHR Battery Test System produced an additional DC current that was supplied through the breakout harness to the high power distribution module. The manufacturer specified that the NHR Battery Test System should supply an additional 1kW of charging power for the test. The maximum normal operating temperature of the battery pack was specified as 50 °C.

The vehicle was charged to 95 percent state of charge prior to the test, resulting in an initial voltage of 393 V. The starting temperature of the battery pack was 20 °C according to the battery management system. The Level 1 charger was secured to the vehicle and charging was confirmed by observing the indicator light on the dash. The vehicle instrument cluster stated that full charge would be reached in 4 hours. The NHR Battery Test System was started and continued to supply its over-charge for 1 hour and 57 minutes, at which point the battery management system terminated charging at 400 V. The indicator light on the dash turned solid green, indicating fully charged. The instrument cluster also stated "Fully Charged." Battery pack temperature was 20 °C as measured by the battery management system. A standard cycle was performed on the vehicle with discharge conducted via vehicle operation and charging completed with the Level 1 charger. No evidence of electrolyte leakage, rupture, venting, fire, or explosion was observed.

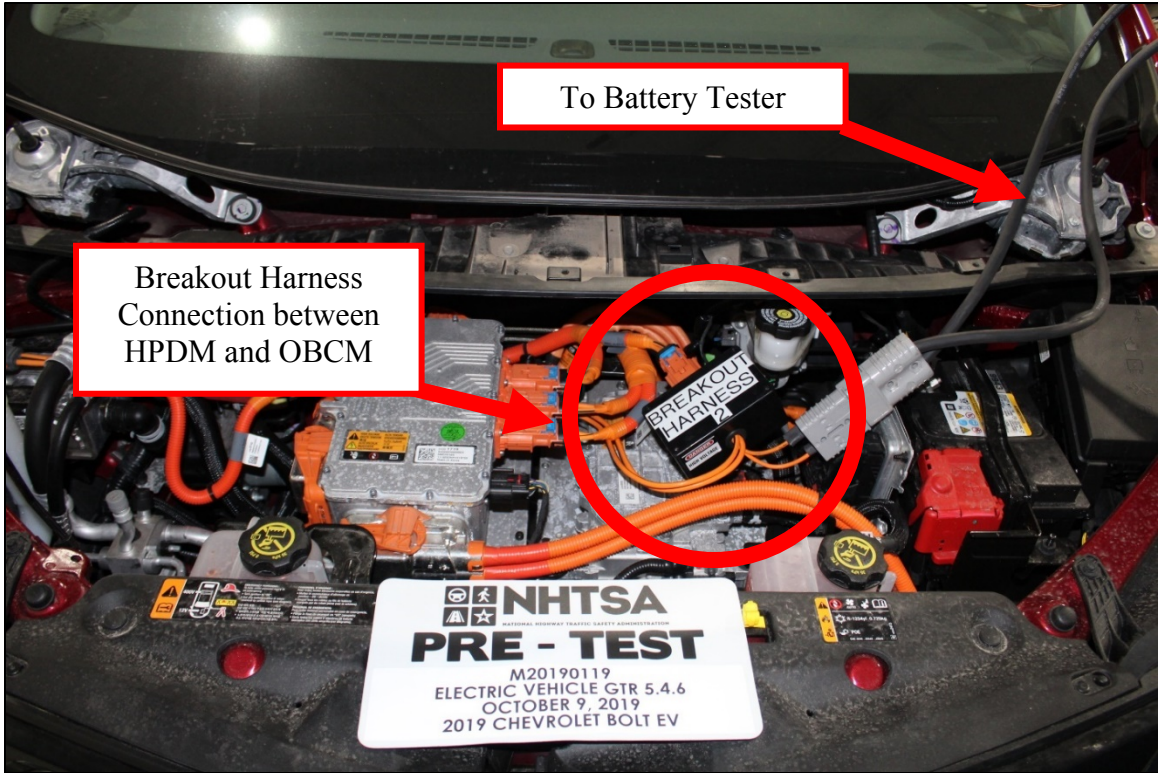

Figure 22: Over-Charge Breakout Harness



Figure 23: Over-Charge Test Setup



Figure 24: Over-Charge Dash Indicator Light



Figure 25: Over-Charge Instrument Cluster Message

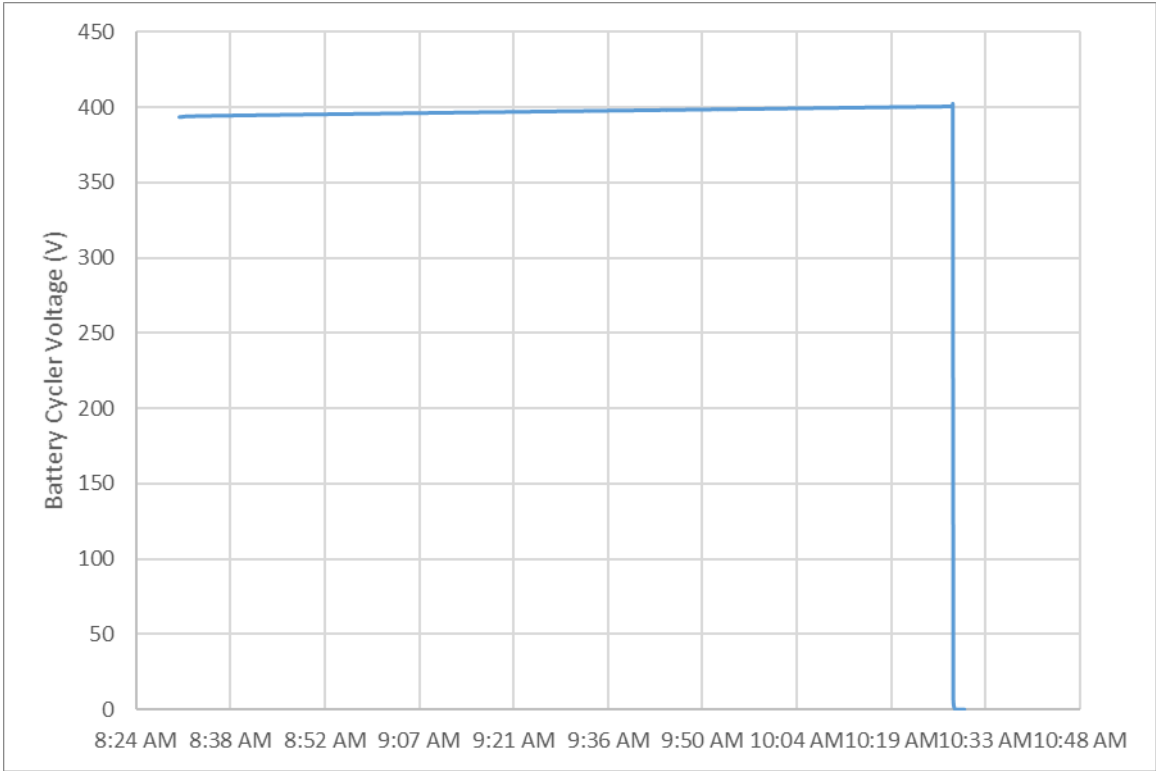

Figure 26: Over-Charge Test Battery Tester Voltage

Figure 27: Over-Charge Test Battery Tester Current (line graph)



Figure 27: Over-Charge Test Battery Tester Current

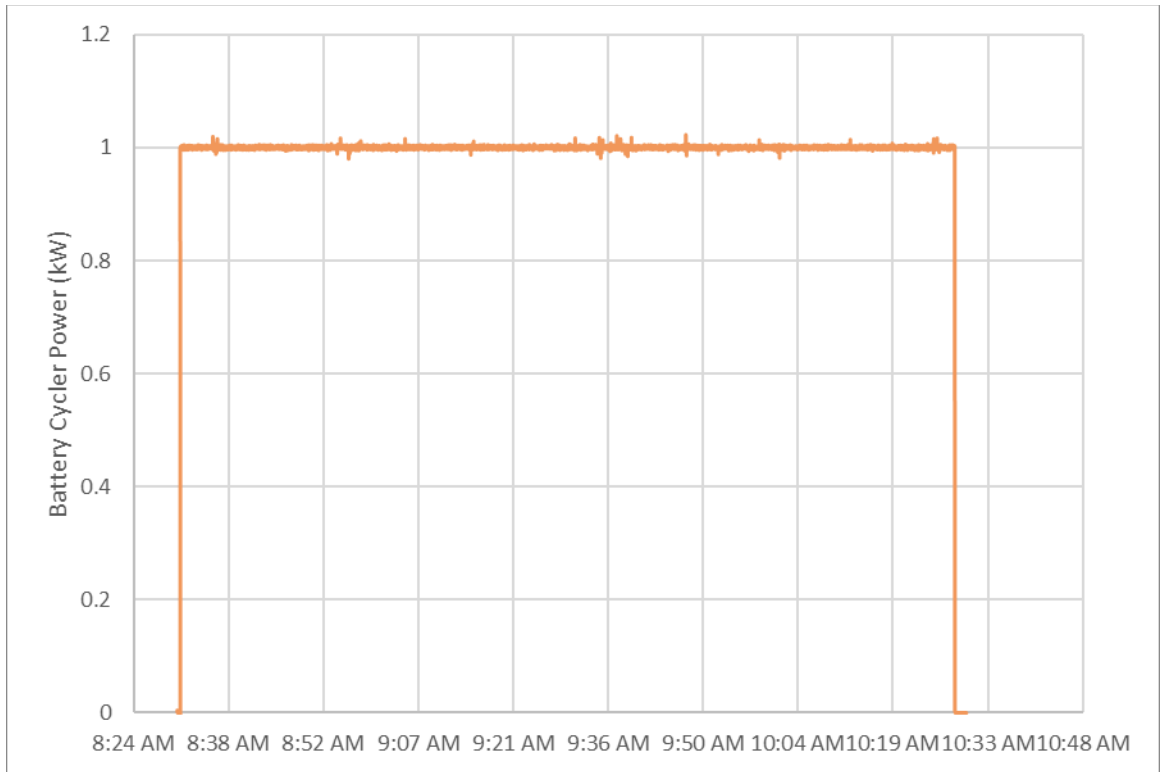

Figure 28: Over-Charge Test Battery Tester Power

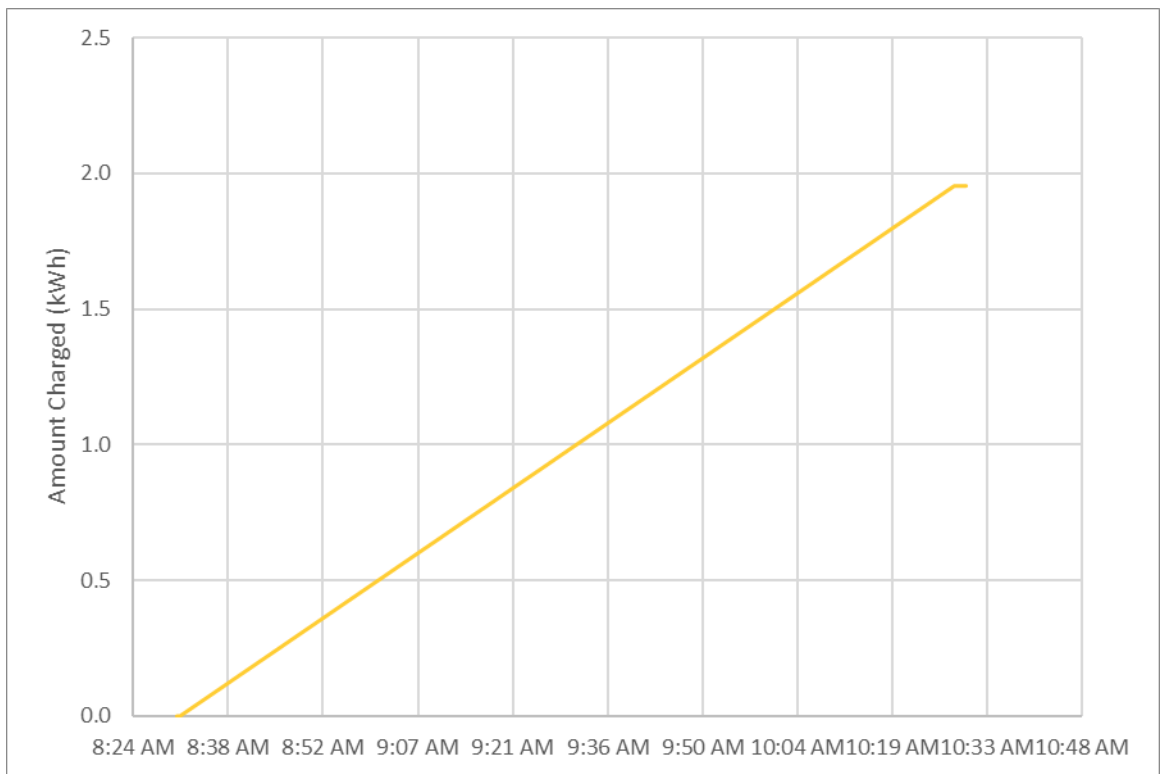

Figure 29: Over-Charge Test Battery Tester Amount Charged

3.8. Over-Discharge Protection (5.4.7)

3.8.1. Procedure feedback and revisions

The GTR No. 20 states that the state of charge of the REESS shall be adjusted at the low level, but in normal operating range. Accurate adjustment is not required, as long as the normal operation of the REESS is enabled. The draft test procedure specifies starting at 3 percent state of charge, or a level recommended by the vehicle manufacturer. The starting state of charge was revised to 10 percent for the validation testing conducted for this report.

Step 14 of the draft test procedure includes an observation for failure, without any time duration. This was modified to include a duration of 1 hour for the observation period as specified in the GTR No. 20.

3.8.2. Validation testing results and discussion (6.2.7)

The manufacturer's breakout harness was connected between the high power distribution module and the single power inverter module. The NHR Battery Test System was connected to the breakout harness and initially programmed to provide a 1 kW discharge rate. The state of charge of the battery was adjusted to approximately 10 percent prior to the test through normal operation, and initial REESS voltage was 330 V. Prior to testing, the vehicle displayed several low energy messages to the driver as outlined in Section 3.4 of this report.

The starting temperature of the battery pack was 23 °C according to the battery management system. The NHR Battery Test System was enabled and the vehicle began discharging at a rate of 1 kW, corresponding to approximately 3 amps. Discharging continued for 107 minutes, until the vehicle manufacturer's onsite representative requested to pause the test to perform diagnostics. The REESS voltage was 326 V when the test was paused. Vehicle power was cycled on and off several times for diagnostics, which is visible in the battery voltage graph in Figure 34. Testing was paused for a total of 20 minutes. At the manufacturer's direction, the discharge rate was increased to 20 amps constant current when testing resumed.

When the battery voltage reached 288 volts the REESS terminated the discharge current. A message displayed on the instrument cluster common space stating "Out of Energy, Charge Vehicle Now!" A standard cycle was performed on the vehicle with the discharge cycle conducted via vehicle operation and the charging cycle using the Level 1 charger. No evidence of electrolyte leakage, rupture, venting, fire, or explosion was observed.

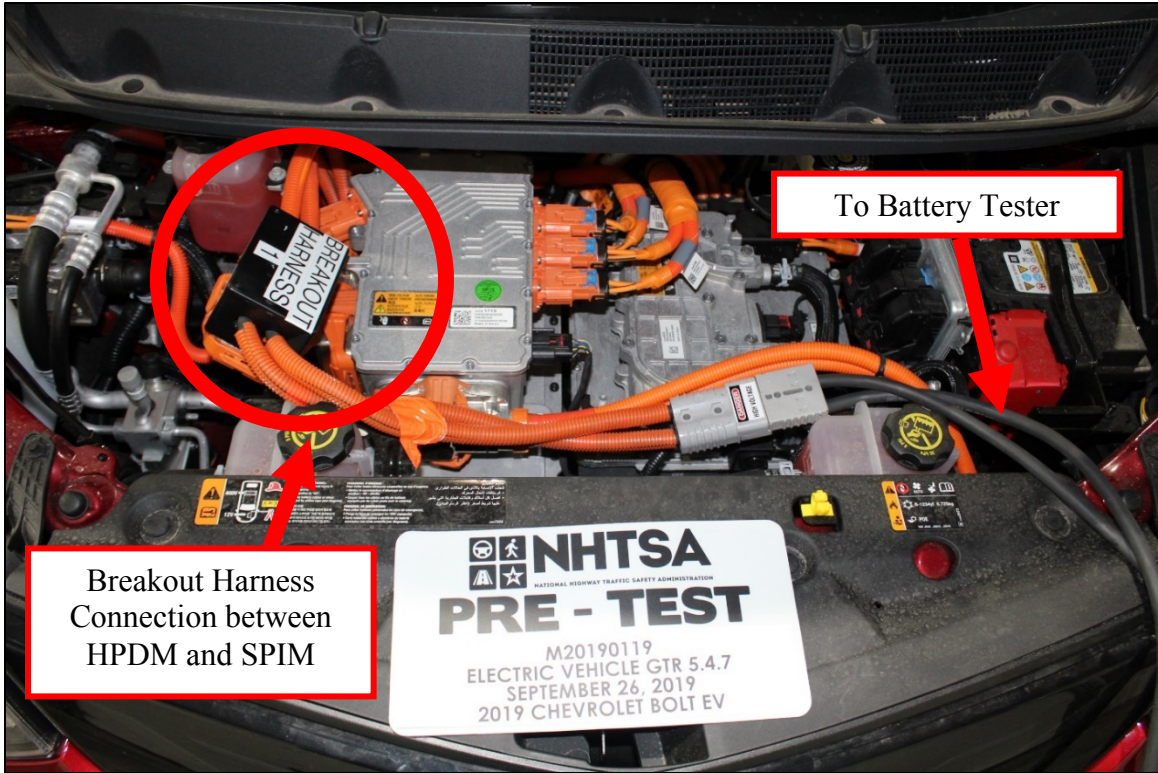

Figure 30: Over-Discharge Breakout Harness



Figure 31: Over-Discharge Test Setup



Figure 32: Over-Discharge Pre-Test Instrument Cluster Message



Figure 33: Over-Discharge Post-Test Instrument Cluster Message

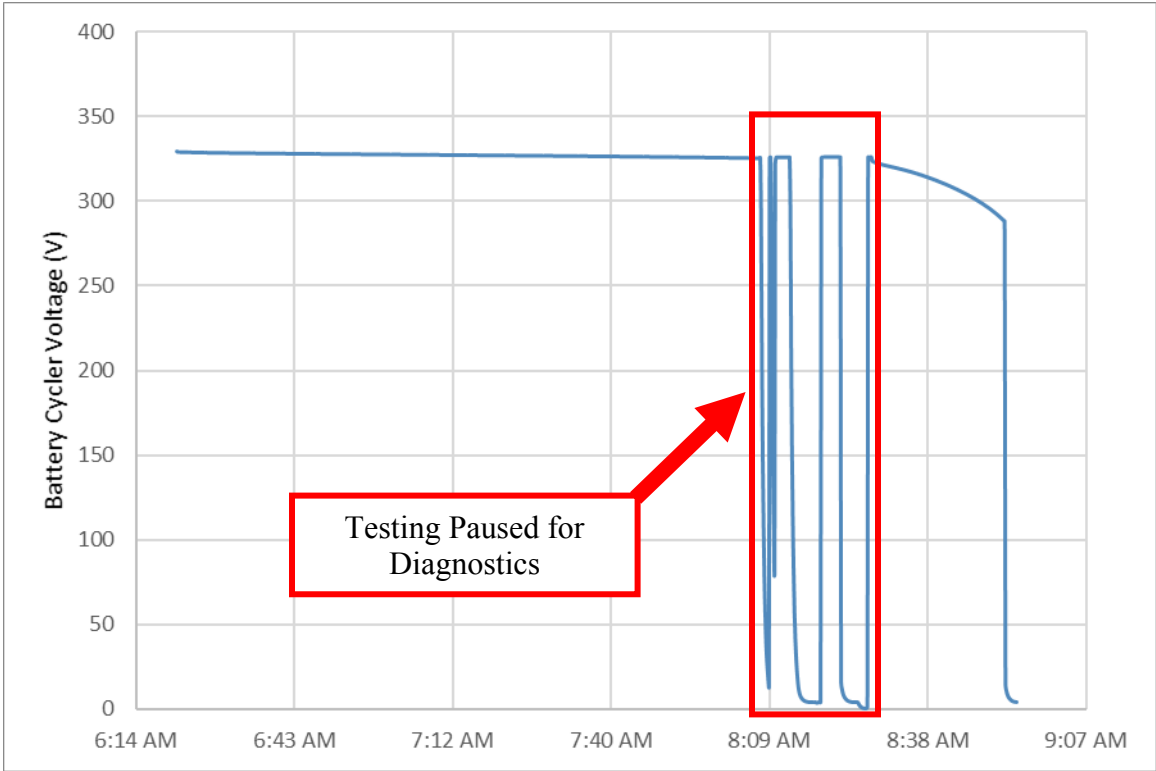

Figure 34: Over-Discharge Test Battery Tester Voltage

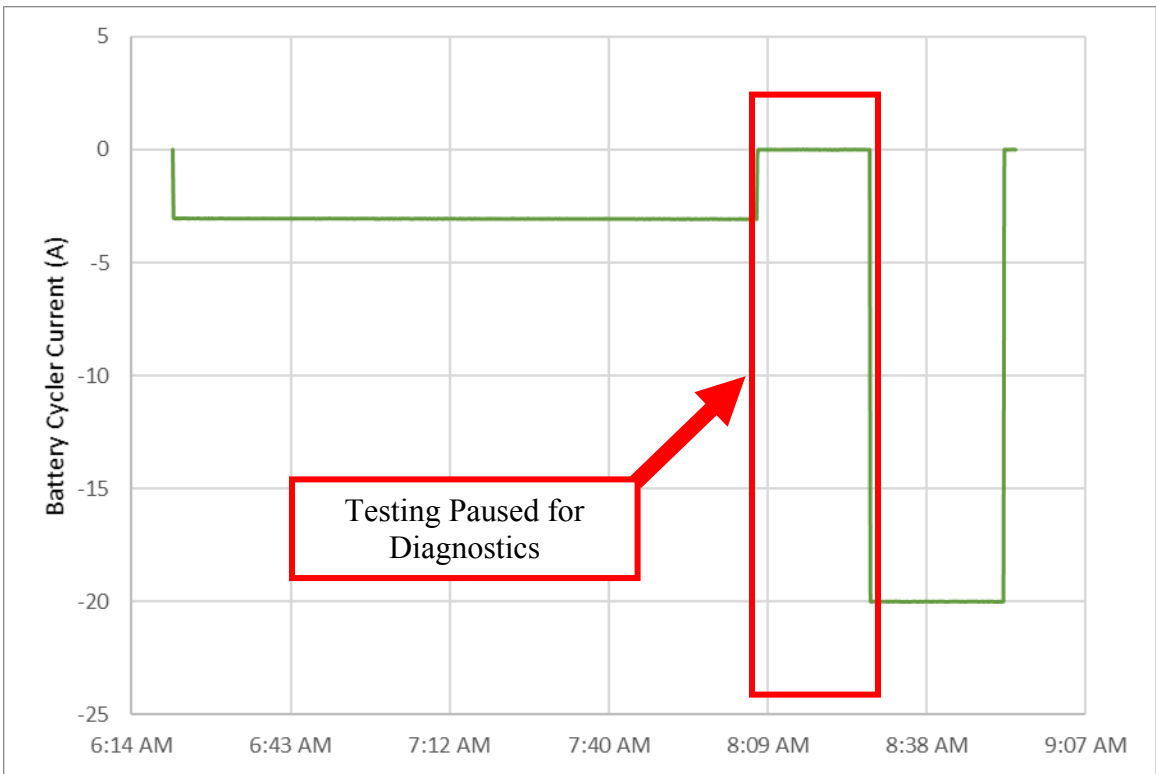

Figure 35: Over-Discharge Test Battery Tester Current

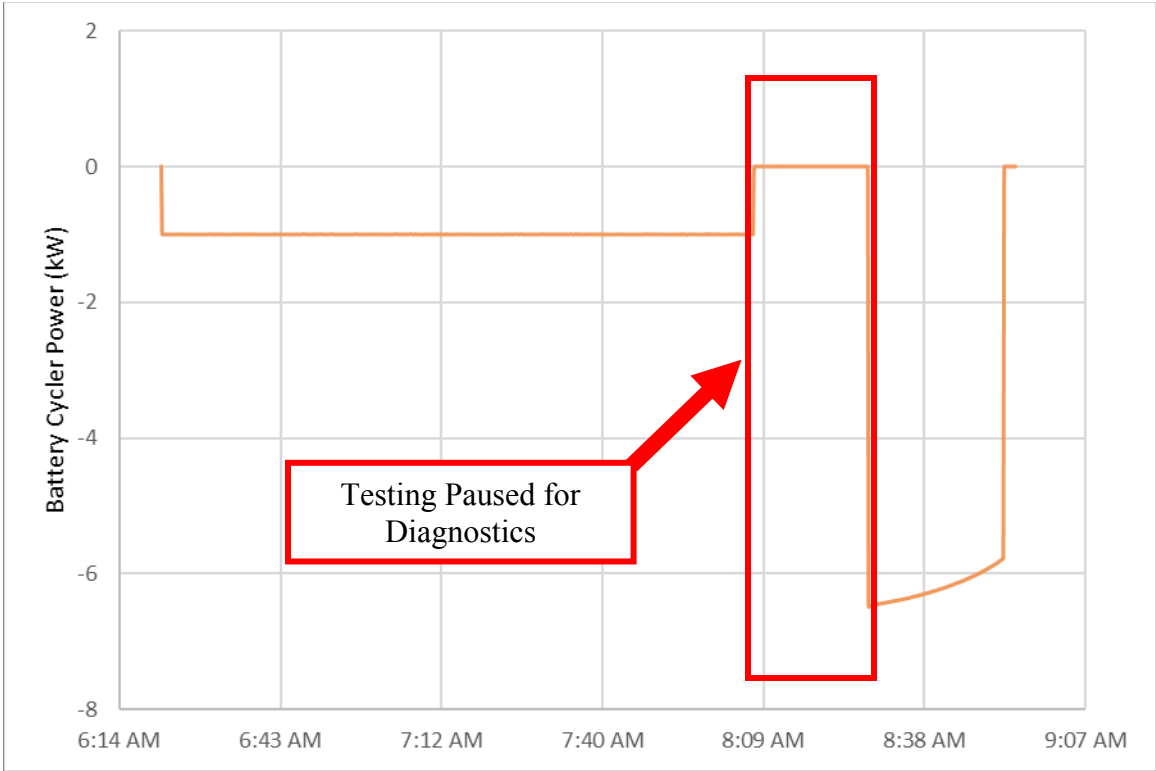

Figure 36: Over-Discharge Test Battery Tester Power

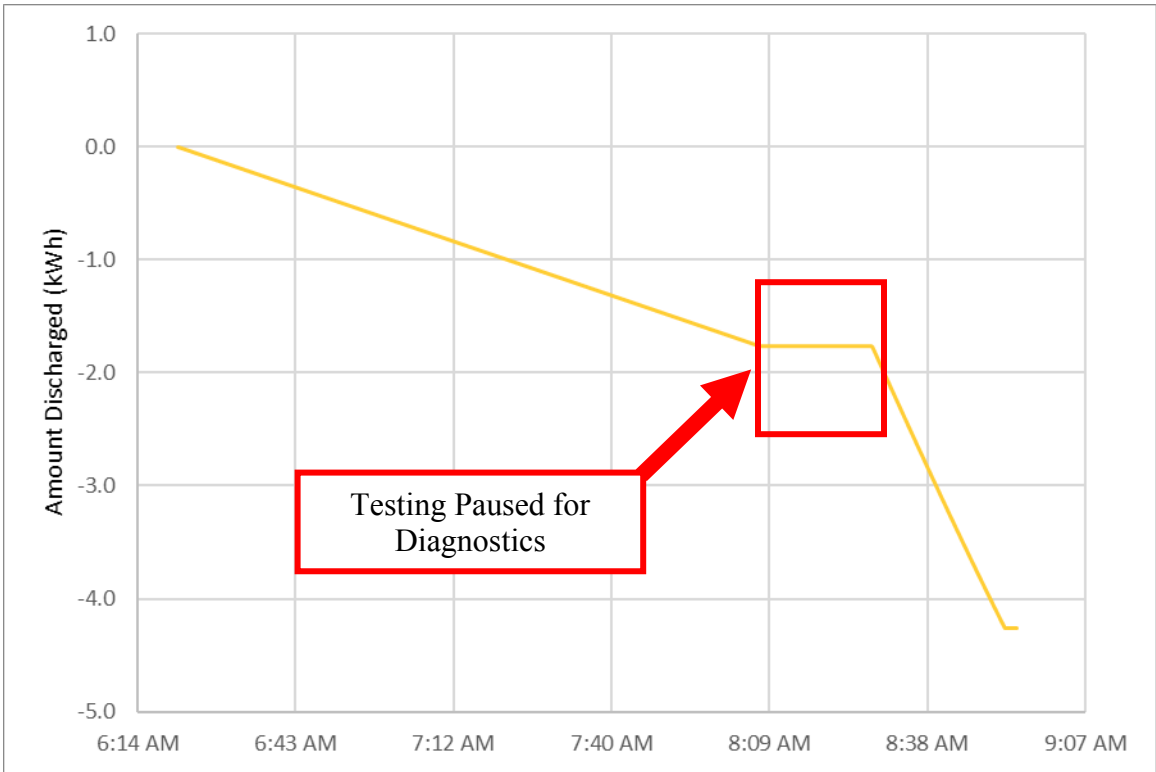

Figure 37: Over-Discharge Test Battery Tester Amount Discharged

3.9. Over-Temperature Protection (5.4.8)

3.9.1. Procedure feedback and revisions

GTR No. 20 section 6.2.8.5.3 states for vehicles with on-board energy conversion systems, adjust the fuel level to nearly empty but so that the vehicle can enter into active driving possible mode. The draft test procedure specifies to verify that the fuel system have sufficient supply to allow operation of the energy conversion system for the 3 hours of testing. There is no mention in the draft test procedure of adjusting the fuel level to nearly empty as stated in the GTR.

Step 10 of the draft test procedure was modified to include item (d) from GTR section 6.2.8.6.2 that states that the test shall end when 3 hours has elapsed from the time of starting the charge/discharge cycles.

3.9.2. Validation testing results and discussion (6.2.8.5)

The vehicle was fully charge with the provided Level 1 charger. In the absence of vehicle manufacturer provided information, the driving profile parameters were identified by conducting several trials on a high-speed test track with the ‘Sport’ driving mode selected. Starting from a complete stop, 0 kph, the vehicle was accelerated with the throttle pedal fully depressed to a maximum velocity of 150 kph. The instrument cluster reported a maximum discharge rate of 150 kW while accelerating to 120 kph, and then began to decrease during acceleration from 120 kph to 150 kph. Based on these trials a driving profile consisting of a repeated acceleration from 24 kph to 120 kph, immediately followed by coasting from 120 kph to 24 kph, was proposed.

The vehicle was placed in an environmental chamber for 12 hours overnight prior to testing. The initial temperature of the chamber was 24 °C, and the controller was set to 43 °C. At the conclusion of the environmental soak the battery temperature was 32 °C.

Prior to installation on the mobile dynamometer, two coolant hoses were crimped to reduce the capacity of the battery cooling system, but not fully restrict coolant flow, following guidance provided by the onsite manufacturer representative. Battery and coolant temperature, battery voltage, and current were recorded from the battery management system through the CAN bus.

Two operators were used to execute the driving profile on the mobile dynamometer, each performing approximately half of the cycles. The driving profile was paused for 60 seconds after 20 minutes to investigate a tire pressure monitoring system warning that appeared on the instrument cluster. Driving resumed after it was determined that the right rear tire sensor had lost communication with the vehicle due to a lack of movement in the rear wheels, and the tire pressure was verified to be in the manufacturer’s specified range. The left rear tire lost communication several minutes after the right rear. The driving profile was also momentarily paused after 90 minutes to accommodate the operator swap.

Battery temperature and coolant temperature measured during the test are presented in Figure 44. Battery temperature decreased during the test setup from its initial value of 32 °C to 23 °C at the start of the driving profile. Battery temperature rose 11 °C during the first 120 minutes of the driving profile. At approximately the 120 minute mark the coolant temperature decreased rapidly to 23 °C , and continued to decline to 18 °C over the next 30 minutes. Battery temperature continued to climb an additional 2 °C during this time, and peaked at 36 °C after 150 minutes of driving. Battery temperature remained at 36 °C for the final 30 minutes of testing, and coolant temperature remained at 18 °C. It was not possibly to quantify the effects of reducing the cooling

system, or the impact that the coolant temperature decrease had on the overall battery temperature. Additional steps may be necessary in future tested to ensure that the cooling system has no, or very minimal, impact during the over-temperature evaluation. Several methods were discussed prior to testing, including disabling the cooling system pump and removing the coolant from the system. There was some concern that these actions would reduce the vehicle's performance from the onset of the driving profile, which is contrary to the intention of the GTR procedure.

The test continued until 3 hours had elapsed from the start of the driving profile discharge/charge cycling. No evidence of electrolyte leakage, rupture, venting, fire, or explosion was observed at the conclusion of the test.



Figure 38: Vehicle Installed on Mobile Dynamometer



Figure 39: Over-Temperature Pre-Test Instrument Cluster



Figure 40: Over-Temperature Coolant Hose Crimps



Figure 41: Over-Temperature Post-Test Instrument Cluster

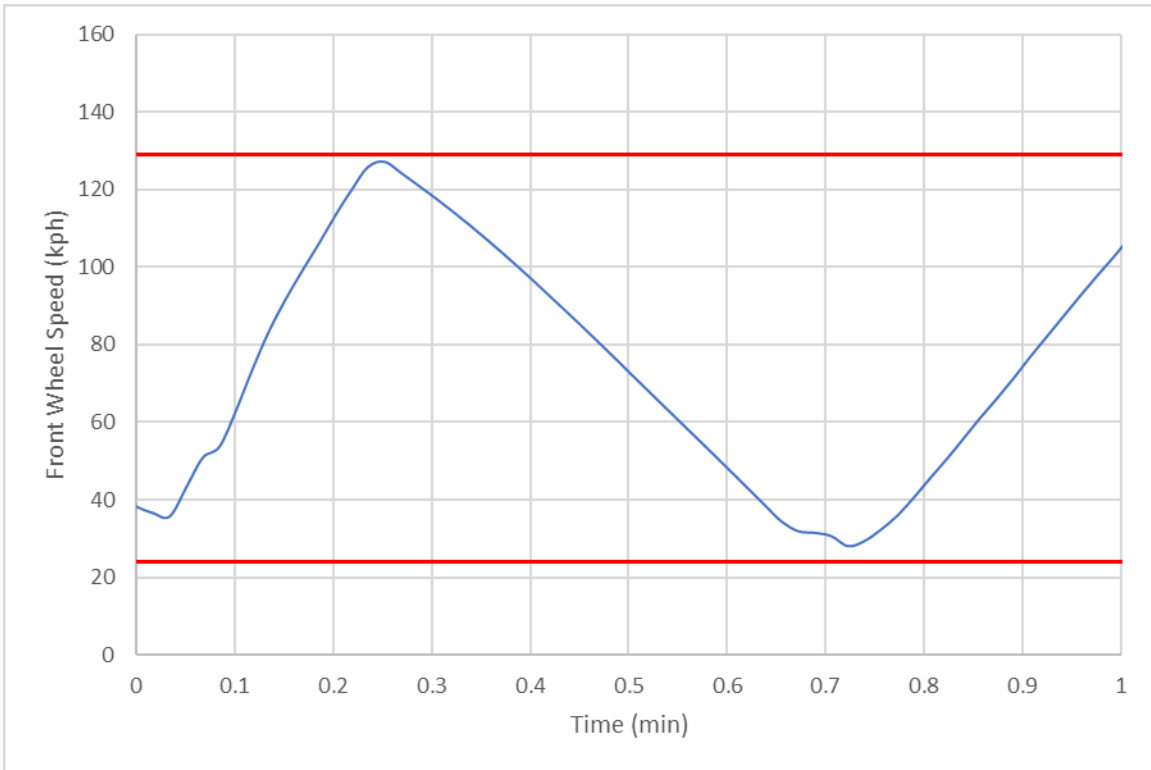

Figure 42: Over-Temperature Test Vehicle Drive Profile – Single Cycle

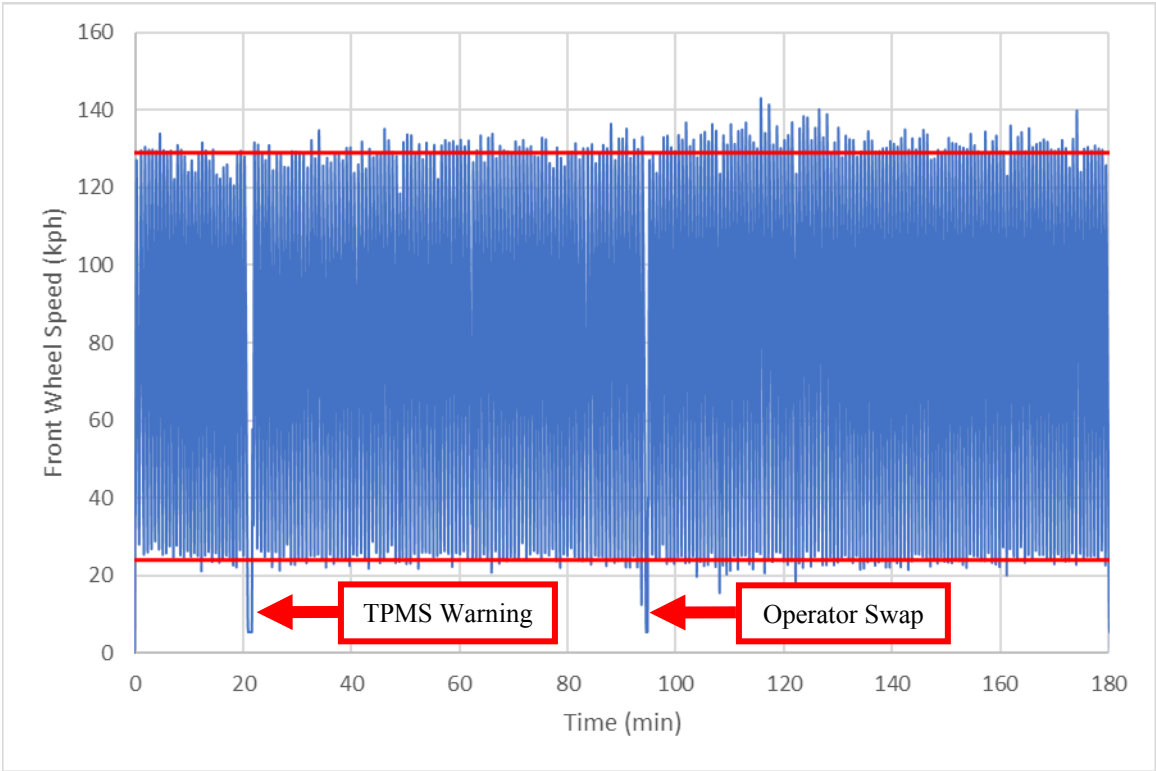

Figure 43: Over-Temperature Test Vehicle Drive Profile

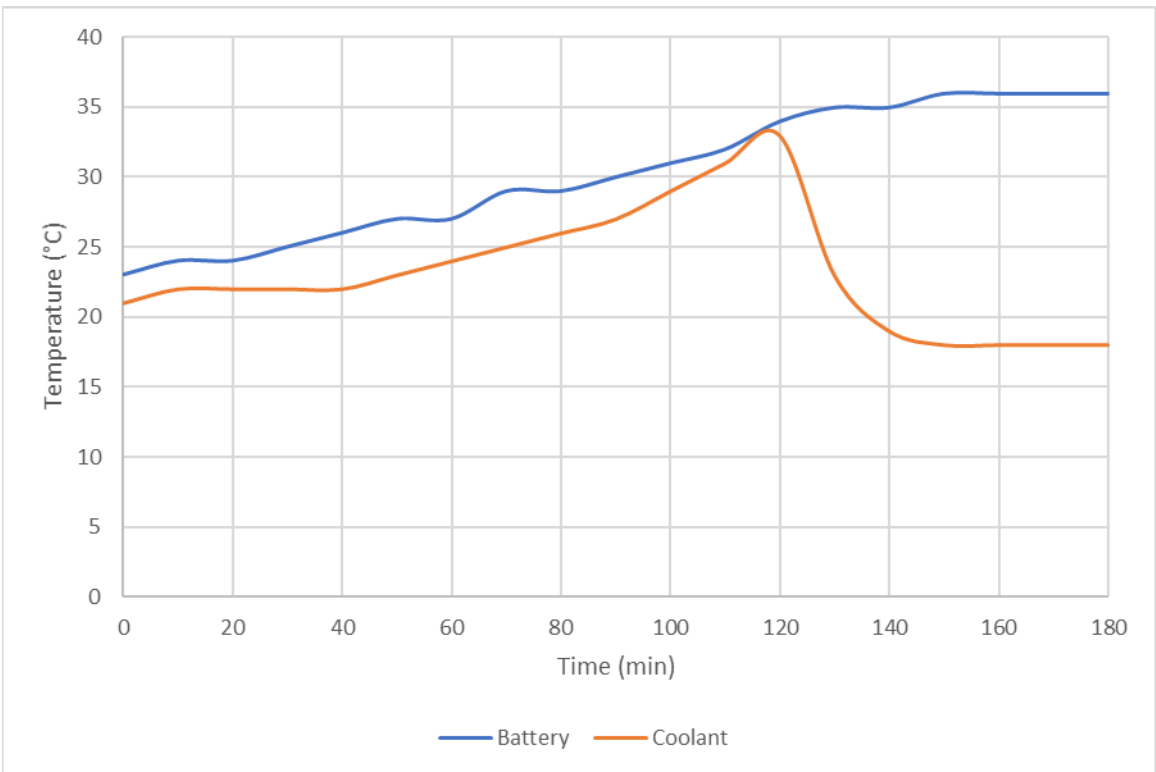

Figure 44: Over-Temperature Test Battery Temperature

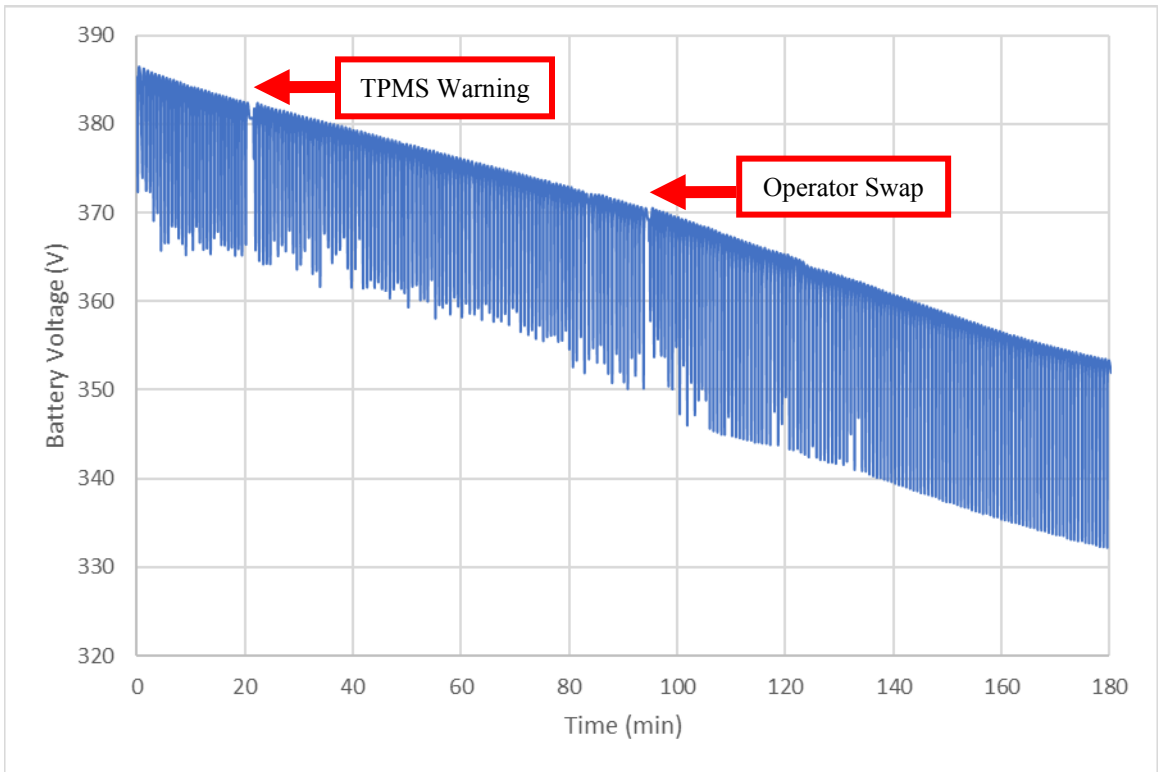

Figure 45: Over-Temperature Test Battery Voltage

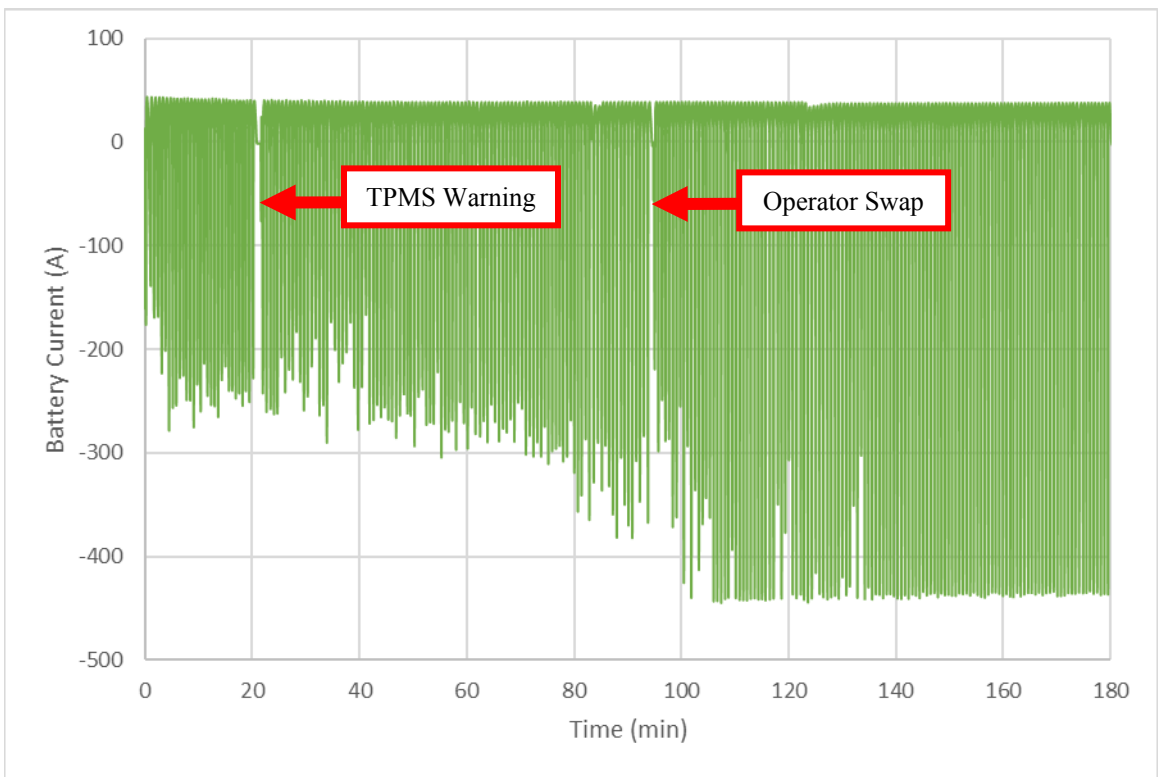

Figure 46: Over-Temperature Test Battery Current

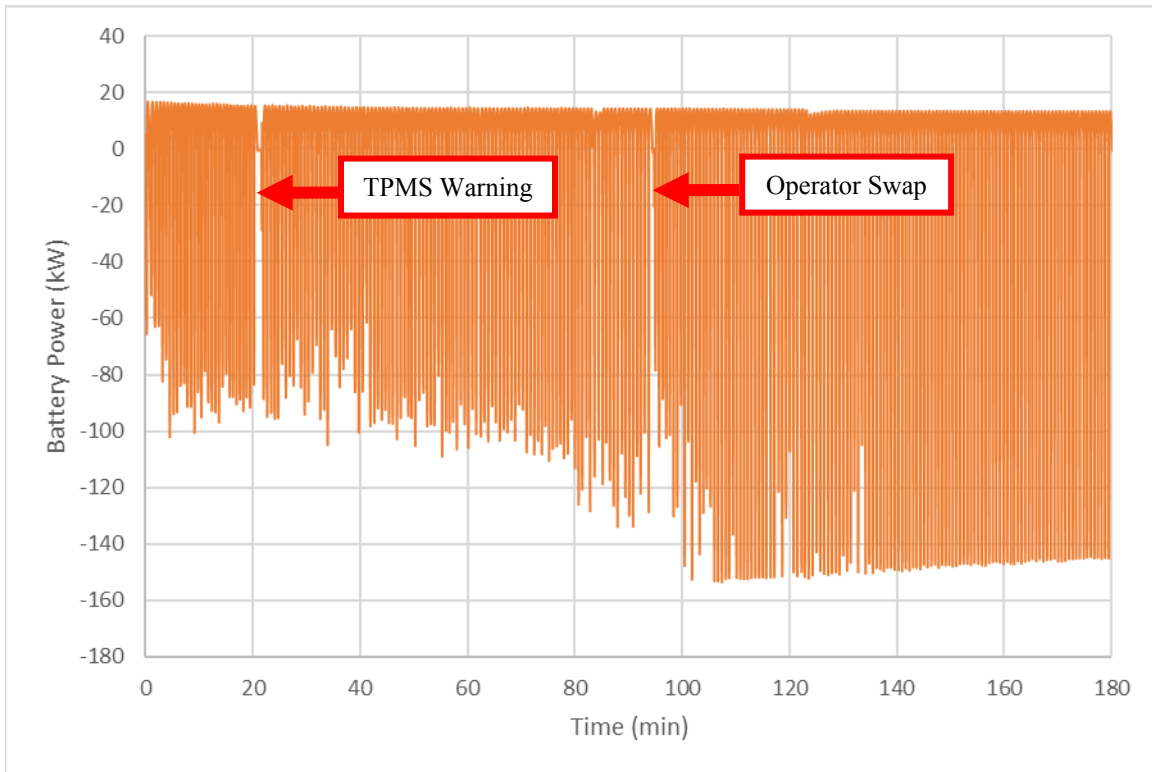

Figure 47: Over-Temperature Test Battery Power

3.10. Over-Current Protection (5.4.9)

3.10.1. Procedure feedback and revisions

Step 14 of the draft test procedure includes an observation period for failure, without any time duration. This was modified to include a duration of 1 hour for the observation period as specified in the GTR No. 20 standard.

3.10.2. Validation testing results and discussion (6.2.9)

The manufacturer's breakout harness was connected between the high power distribution module and the DC fast charger port. The NHR battery test system was connected to the breakout harness and programmed to supply 4 amp current steps up to a total of 20 additional amps. The state of charge of the battery was adjusted to approximately 50 percent prior to the test through normal operation, and initial REESS voltage was 354 V. A DC fast charger was used in conjunction with the battery test system according to the manufacturer's supplied test methodology. The DC fast charger provided the handshake communication required by the vehicle to close the contactors in the REESS and allow charging. At 50 percent state of charge the DC fast charger supplied 100 amps to the vehicle. The starting temperature of the battery pack was 20 °C according to the battery management system.

Several attempts to initialize the test were required to determine the proper sequence of starting the DC fast charger and battery test system. For the first attempt, the battery test system was enabled prior to the DC fast charger's ground fault check and caused an alert on the DC fast charger and the necessary contactors in the vehicle for charging remained open. The battery state

of charge was adjusted to approximately 70 percent during these attempts, and the REESS voltage was 378 V. The DC fast charger supplied 60 amps to the vehicle at this state of charge.

For the second attempt, the battery test system was enabled after the DC fast charger had initiated charging. The battery test system began increasing current output by 4 amps every minute. At each step the DC fast charger reduced its current output in a manner that kept the total current input to the vehicle at approximately 60 amps. This continued until the battery test system output reached 16 amps. The vehicle terminated charging 12 seconds after the battery test system switched from 12 amps to 16 amps. The DC fast charger terminated charging, illuminated the failure indicator light, and displayed a message stating “Error Vehicle Battery Malfunction.” A message displayed on the vehicle’s instrument cluster stated “Unable to Charge.” The DC fast charger was disconnected from the breakout harness and vehicle was power cycled once. The vehicle powered on normally and accepted charging from the Level 1 charger. A standard cycle was performed on the vehicle with discharge conducted via vehicle operation and charging completed with the Level 1 charger. No evidence of electrolyte leakage, rupture, venting, fire, or explosion was observed.

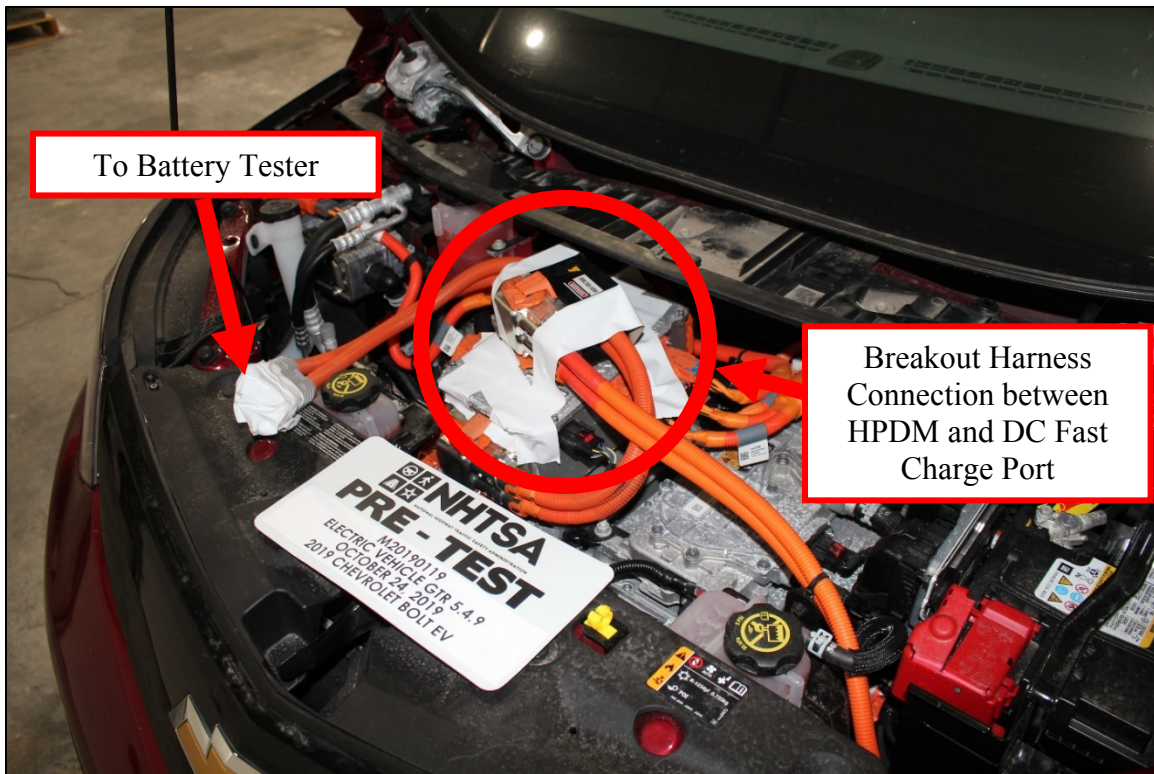

Figure 48: Over-Current Breakout Harness



Figure 49: DC Fast Charger



Figure 50: Over-Current Pre-Test Instrument Cluster Message

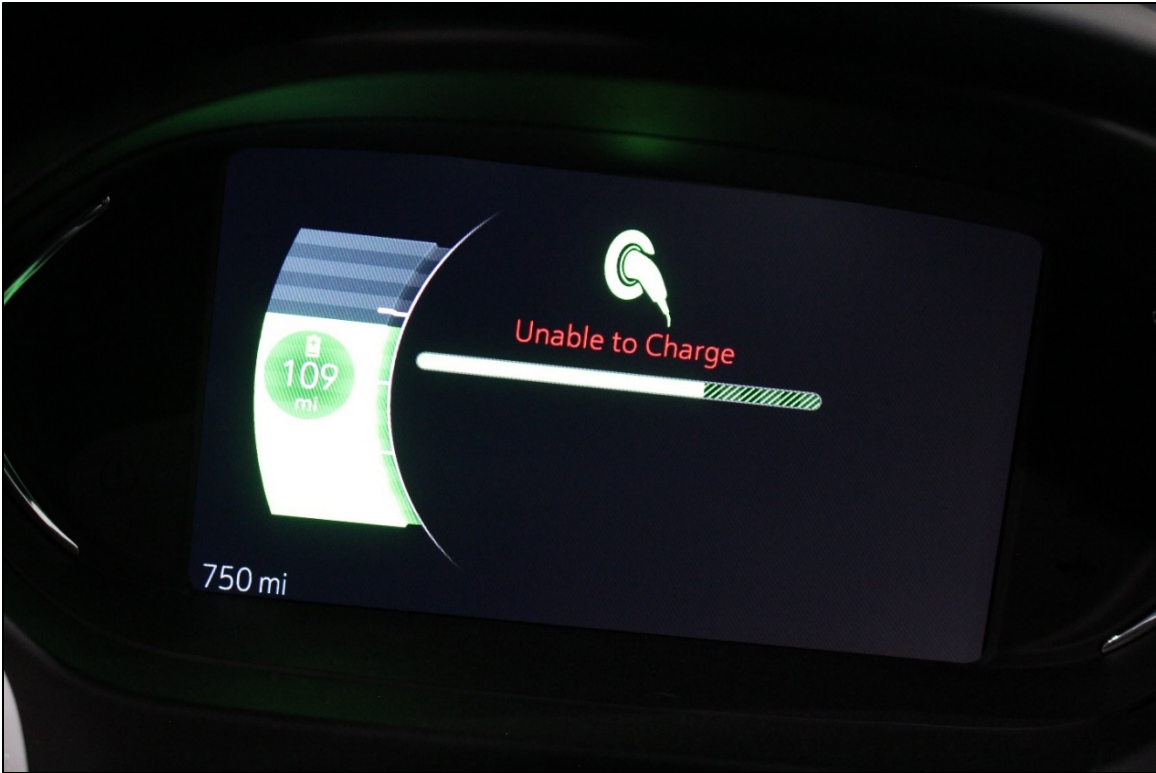

Figure 51: Over-Current Post-Test Instrument Cluster Message

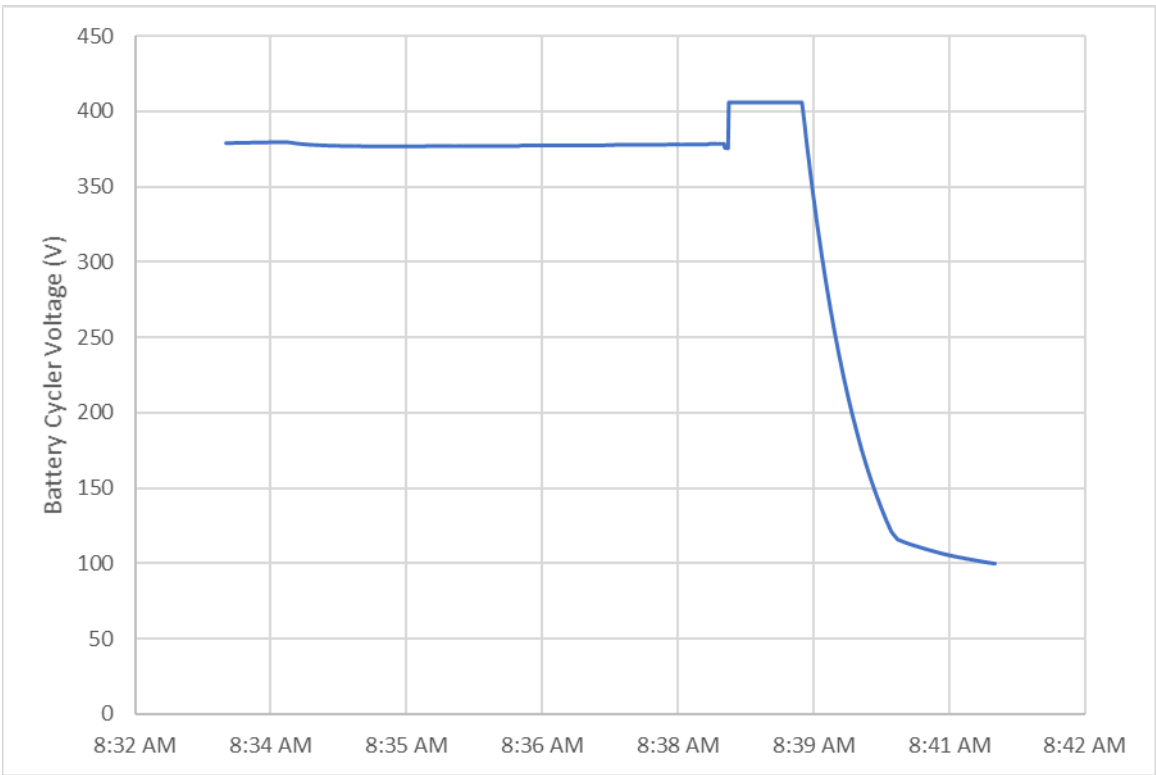

Figure 52: Over-Current Test Battery Tester Voltage

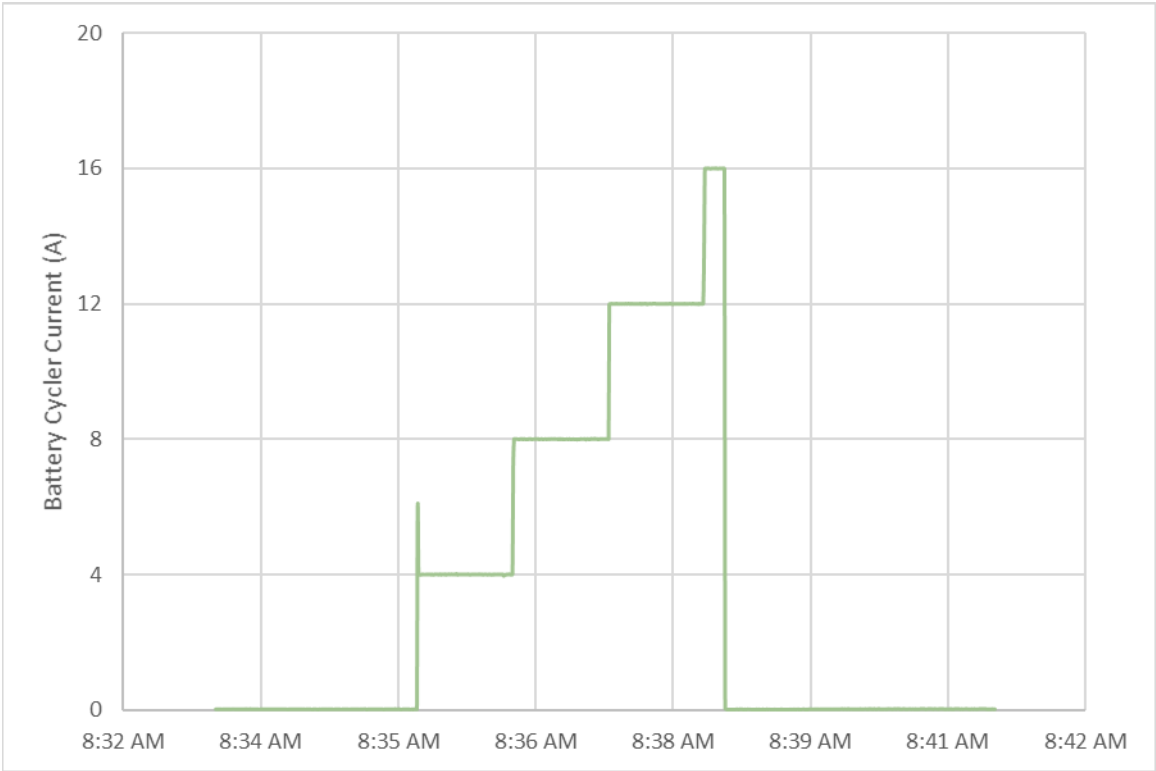

Figure 53: Over-Current Test Battery Tester Current

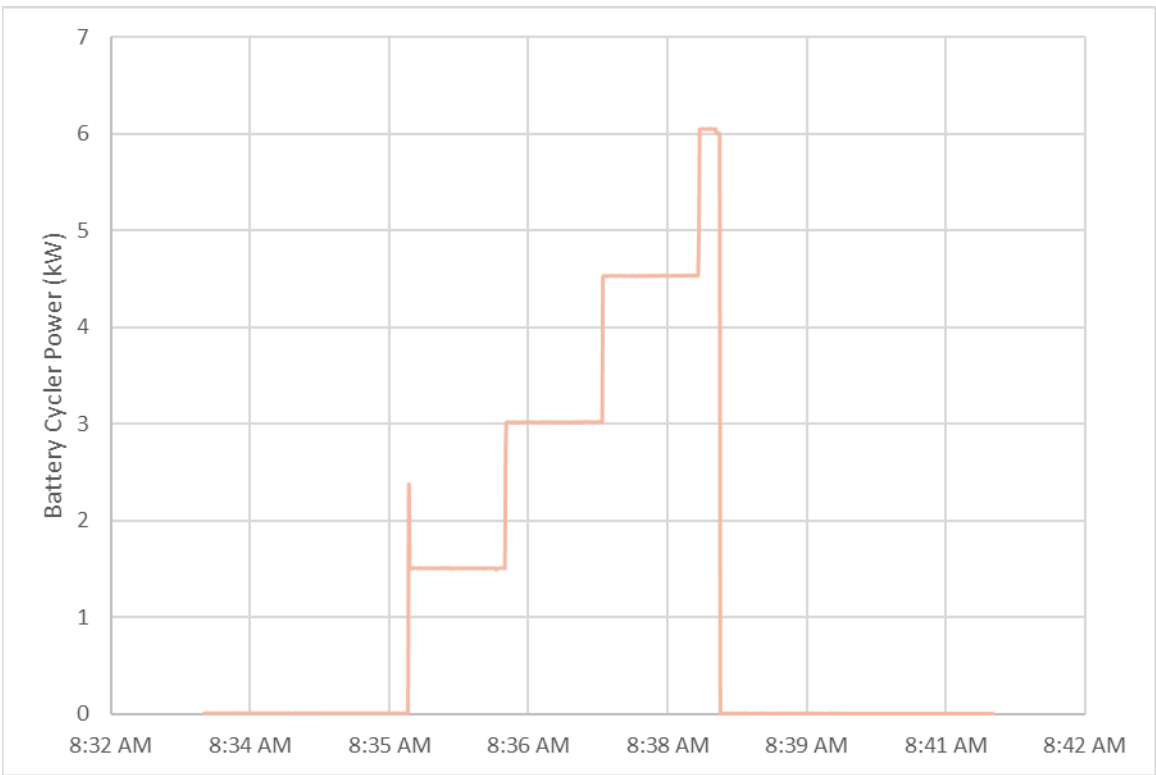

Figure 54: Over-Current Test Battery Tester Power

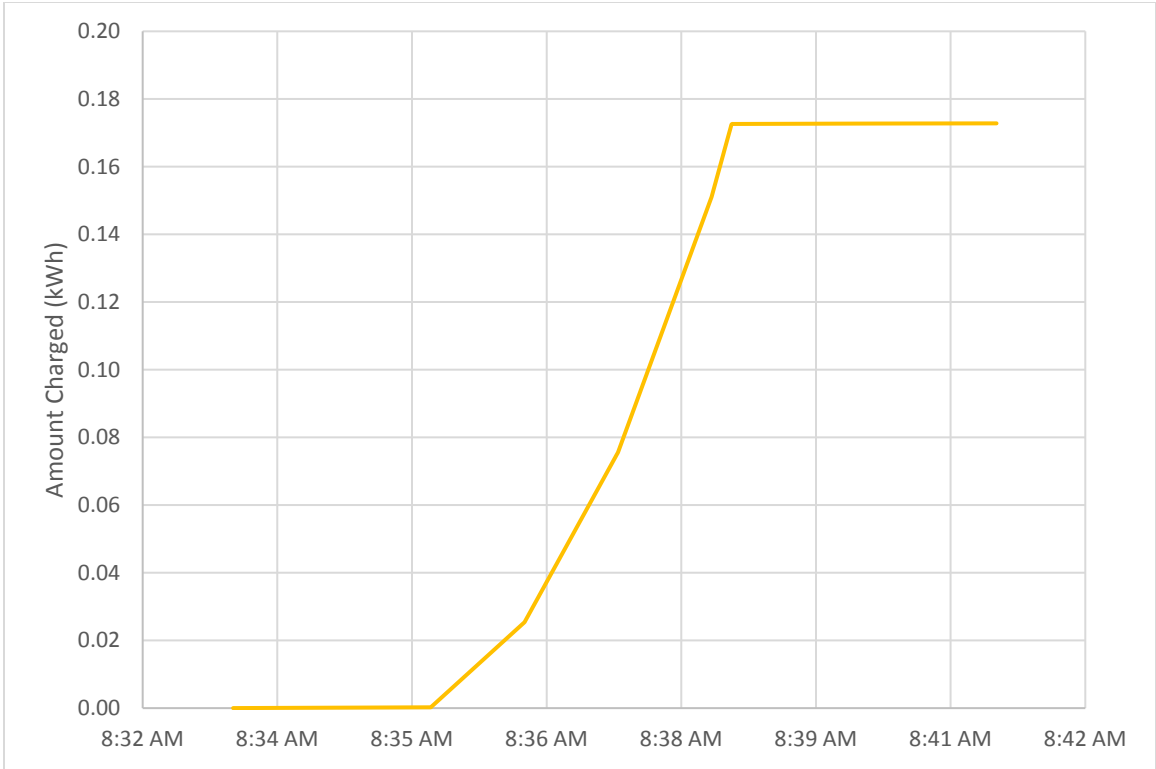

Figure 55: Over-Current Test Battery Tester Amount Charged

4. Conclusions

The following sections of GTR No. 20 were evaluated in this report.

- 5.1.1.1 Protection against direct contact
- 5.1.1.2 Protection against indirect contact
- 5.1.2.1 Momentary indication when placed in active driving mode
- 5.1.2.2 Driver to be informed when leaving vehicle
- 5.1.2.4 Vehicle movement during charging
- 5.3.2 Warning in event of operation failure
- 5.3.3 Warning in case of thermal event in REESS
- 5.3.4 Warning in event of low energy content of REESS
- 5.4.5 External short circuit protection
- 5.4.6 Over-charge protection
- 5.4.7 Over-discharge protection
- 5.4.8 Over-temperature protection
- 5.4.9 Over-current protection

A revised laboratory test procedure was created based on the draft test procedure detailed in this report, incorporating the recommendations presented below.

The following recommendations are presented based on the experiences of the validations testing.

- Create a procedure and refine supporting forms to improve the sharing of information between the regulatory body, test laboratory, and vehicle manufacturer. A proposed form is presenting in Appendix A of this report, but evaluation and revisions will be necessary to validate its effectiveness.
 - Many of the test procedures required by GTR No. 20 require the vehicle manufacturer supply technical information to the test laboratory. In several instances the primary regulatory contacts at the vehicle manufacturer did not have this information, and instead consultation with subject matter experts at the vehicle manufacturer was necessary. This process significantly increased the time and complexity in completing the testing.
- Quantify and record all electrical inputs into the vehicle during “in-use” testing.
 - May require additional components to be added to the breakout harness to allow for voltage and current monitoring through the harness in cases where the battery test system is used in conjunction with additional external chargers.
- Investigate the use of a battery test system for applying the standard cycles.
- Investigate increasing the starting state of charge for the over-charge test to 95 percent.

The validations conducted in this report are limited by their scope, only one validation of each test method was conducted on a single vehicle model. In each case, the battery management system terminated the test in accordance with the requirements of the GTR No. 20 standard. Therefore, the end of test conditions outlined in the GTR No. 20 and draft test procedures that rely on a prescribed amount of time of observation of REESS temperature were not validated. Isolation measurements were not performed at the conclusion of “in-use” validations, but this procedure was evaluated for the protection against indirect contact. No failure modes were observed or validated during this test series. The subject test vehicle was not equipped with an on-board energy conversion system (i.e., hybrid) and the corresponding test methods were not validated. Finally, test repeatability was not addressed during the validation testing.

Appendix A: Example of Pre-Test Information Sheet for GTR Testing

TEST VEHICLE INFORMATION FOR HYBRID AND ELECTRIC VEHICLES (for GTR No. 20)

Vehicle Model Year and Make:

Vehicle Model and Body Style:

GVWR: _____ lbs, _____ kg

GAWR Front: _____ lbs, _____ kg

GAWR Rear: _____ lbs, _____ kg

Please provide instructions via electronic link or attachment that may be useful or necessary in relation to FMVSS No. 305 in preparing the battery system and/or vehicle pre-test, executing the crash test (immediately prior to and after the crash event), performing assessment of the battery system and/or vehicle post-test (including handling instructions), and battery discharge instructions.

TIRES:

Manufacturer:

Location of Placard on Vehicle:

Recommended Tire Size: _____

Recommended Cold Tire Pressure:

Front: _____ kPa; Rear: _____ kPa

Size of Tires on Test Vehicle:

Type of Spare Tire:

Tire Pressure with Maximum Capacity Vehicle Load:

Front: _____ kPa; Rear: _____ kPa

VEHICLE CAPACITY DATA

Type of Front Seat(s):

Number of Occupants:

Front: _____ Rear: _____ Total: _____

Vehicle Capacity Weight (VCW): _____ kg

Number of Occupants x 68 kg: _____ kg

Rated Cargo and Luggage Weight (RCLW): _____ kg

ELECTRONIC VEHICLE PROPULSION SYSTEM:

Type of Electric Vehicle Propulsion (Electric/Gas-Electric Hybrid/Fuel Cell-Electric Hybrid):

Propulsion Battery Type:

Nominal Voltage: _____ V

Is this vehicle equipped with an Automatic Propulsion Battery Disconnect?

YES NO

Physical Location of Automatic Propulsion Battery Disconnect?

Auxiliary Battery Type:

PROPULSION BATTERY SYSTEM DATA:

Electrolyte Fluid Type:

Electrolyte Fluid Specific Gravity: _____

Electrolyte Fluid Kinematic Viscosity: _____

Electrolyte Fluid Color:

Propulsion Battery Coolant:

Propulsion Battery Coolant Color (if applicable):

Location of Battery Modules (Check location):

- Inside Passenger Compartment
- Outside Passenger Compartment

Propulsion Battery State of Charge:

Maximum State of Charge: _____ V

-OR-

Range of Normal Operating Voltage: _____ V

Provide step-by-step instructions on how to charge the propulsion battery system to the level specified in (1), (2), or (3) below **along with how to verify condition is met:**

1. The voltage corresponding to the maximum state of charge recommended by the manufacturer, as stated in the vehicle's owner's manual or on a label that is permanently affixed to the vehicle;

-OR-

2. If the manufacturer has made no recommendation, a voltage corresponding to a state of charge of not less than 95 percent of the maximum capacity of the battery system;

-OR-

3. If the batteries are rechargeable only by an energy source on the vehicle, how to operate the vehicle such that the maximum practicable state of charge within the normal operating range, as specified by the manufacturer, is reached as indicated by the vehicle's instrumentation, if installed, or using other measurement methods.

VEHICLE CHASSIS GROUND POINT(S) LOCATION(S):

What is the recommended chassis ground point(s) & location(s) for measurement of electrical isolation? Attach necessary documentation.

PROPULSION BATTERY SYSTEM:

What are the recommended positive and negative measurement points for automatic disconnect and propulsion battery? Attach necessary documentation.*

What is the recommended method for attaching test leads to measurement points? Attach necessary documentation.*

* Attach .pdf of First Responder's manual or Service Manual (or website link to information), if applicable.

TESTING PERFORMED BY YOUR COMPANY:

Vehicle Model Year and Make:

Vehicle Model and Body Style:

Test No.: _____ VIN:

Build Date: _____ GVWR/LLVW: _____ lbs

Transmission Type:

Automatic

Manual

List all FMVSS tests performed on this vehicle:

PRE-IMPACT DATA:

Propulsion Battery Voltage:

V1: _____ V V2: _____ V

Propulsion Battery to Vehicle Chassis:

V1: _____ V V2: _____ V

Propulsion Battery to Vehicle Chassis Across Resistor:

Ro: _____ Ω Ri/Vb: _____ Ω/V (Electrical Isolation Value)

POST-IMPACT DATA:

Propulsion Battery to Vehicle Chassis:

V1: _____ V V2: _____ V

Propulsion Battery to Vehicle Chassis Across Resistor:

Ro: _____ Ω Ri/Vb: _____ Ω/V (Electrical Isolation Value)

TESTING PERFORMED BY YOUR COMPANY:

Vehicle Model Year and Make:

Vehicle Model and Body Style:

Test No.: _____ VIN:

Build Date: _____ GVWR/LLVW: _____ lbs

Transmission Type:

Automatic

Manual

List all FMVSS tests performed on this vehicle:

PRE-IMPACT DATA:

Propulsion Battery Voltage:

V1: _____ V V2: _____ V

Propulsion Battery to Vehicle Chassis:

V1: _____ V V2: _____ V

Propulsion Battery to Vehicle Chassis Across Resistor:

Ro: _____ Ω Ri/Vb: _____ Ω/V (Electrical Isolation Value)

POST-IMPACT DATA:

Propulsion Battery to Vehicle Chassis:

V1: _____ V V2: _____ V

Propulsion Battery to Vehicle Chassis Across Resistor:

Ro: _____ Ω Ri/Vb: _____ Ω/V (Electrical Isolation Value)

TESTING PERFORMED BY YOUR COMPANY:

Vehicle Model Year and Make:

Vehicle Model and Body Style:

Test No.: _____ VIN:

Build Date: _____ GVWR/LLVW: _____ lbs

Transmission Type:

Automatic

Manual

List all FMVSS tests performed on this vehicle:

PRE-IMPACT DATA:

Propulsion Battery Voltage:

V1: _____ V V2: _____ V

Propulsion Battery to Vehicle Chassis:

V1: _____ V V2: _____ V

Propulsion Battery to Vehicle Chassis Across Resistor:

Ro: _____ Ω Ri/Vb: _____ Ω/V (Electrical Isolation Value)

POST-IMPACT DATA:

Propulsion Battery to Vehicle Chassis:

V1: _____ V V2: _____ V

Propulsion Battery to Vehicle Chassis Across Resistor:

Ro: _____ Ω Ri/Vb: _____ Ω/V (Electrical Isolation Value)

SPECIAL INSTRUCTIONS, HAZARDS, AND PRECAUTIONS:

Provide any special instructions, hazards, and precautions while working on the vehicle:

Also provide a current Material Safety Data Sheet (MSDS) for the battery and any other hazardous components.

PROPULSION BATTERY SYSTEM COMPONENTS:

Describe the propulsion battery module movement within the passenger compartment, if applicable:

Describe intrusion of an outside propulsion battery component into the passenger compartment, if applicable:

Describe propulsion battery electrolyte spillage or leakage into the passenger compartment, if applicable:

Additional Comments:

GROUNDING EXTERNAL CHARGING:

Provide any drawings or materials to support compliance of GTR 5.1.1.2.3:

EXTERNAL CHARGING SYSTEMS (IF APPLICABLE):

Provide part numbers and specifications of all external charging options:

WARNING INDICATION TO THE DRIVER:

Provide a description of the warning to the driver in the event of operational failure of REESS safety controls:

Provide a description of the warning to the driver in the event of a thermal event within the REESS:

Provide a description of the warning to the driver in the event of low energy content of the REESS:

STANDARD CYCLE:

Provide discharge rate and procedure for a standard cycle (including end voltage):

EXTERNAL SHORT CIRCUIT:

Provide a breakout harness along with installation instructions for short circuit testing:

OVERCHARGE:

Provide a breakout harness along with installation instructions for over-charge testing. Provide maximum charge current and voltage limit of the tested device, and the maximum operating temperature of the REESS:

OVER-DISCHARGE:

Provide a breakout harness along with installation instructions for over-discharge testing. Provide the maximum discharge rate or choose to use a 1 kW resistor:

OVER-TEMPERATURE:

Provide a procedure for disabling the REESS cooling system to the extent possible while maintaining REESS operation:

OVERCURRENT:

Provide a breakout harness along with installation instructions for overcurrent testing. Provide maximum current and voltage of the external DC supply equipment, and the maximum normal operating charging current of the external DC supply equipment:

REESS TEMPERATURE MONITORING:

Provide a procedure for monitoring the temperature of the REESS during testing:

DOT HS 813 092
April 2021



U.S. Department
of Transportation
**National Highway
Traffic Safety
Administration**

