

**NEW CAR ASSESSMENT PROGRAM (NCAP)
DYNAMIC ROLLOVER RESISTANCE TEST**

Hyundai Motor Company
2020 Hyundai Palisade SEL FWD

TEST NUMBER: NCAP-DRI-RR-20-08

Final Report
6 May 2020



Prepared by:

Dynamic Research, Inc.
355 Van Ness Ave. #200
Torrance, CA 90501

Prepared for:

National Highway Traffic Safety Administration
New Car Assessment Program
1200 New Jersey Avenue S.E.
Washington, DC 20590

The United States Government assumes no liability for the contents of this report or use thereof. If trade or manufacturers' names or products are mentioned, it is only because they are considered essential to the object of the publication and should not be construed as an endorsement. The United States Government does not endorse products or manufacturers.

Dynamic Research, Inc. does not endorse or certify products of manufacturers. The manufacturer's name appears solely to identify the test article. Dynamic Research, Inc. assumes no liability for the report or use thereof. It is responsible for the facts and the accuracy of the data presented herein. This report does not constitute a standard, specification, or regulation.

Report Prepared by:

John Lenkeit, Program Manager

Date: 6 May 2020

Stephen Rhim, Test Engineer

1. Report No. NCAP-DRI-RR-20-08	2. Government Accession No.	3. Recipient's Catalog No.	
4. Title and Subtitle NCAP Dynamic Rollover Resistance Maneuver (Fishhook) Test of a 2020 Hyundai Palisade SEL FWD		5. Report Date 6 May 2020	6. Performing Organization Code DRI
		8. Performing Organization Report No. DRI- TM-18-114	
7. Author(s) John Lenkeit, Program Manager Stephen Rhim, Test Engineer		10. Work Unit No. (TRAIS)	
9. Performing Organization Name and Address Dynamic Research, Inc. 355 Van Ness Ave. #200 Torrance, CA 90501		11. Contract or Grant No. DTNH22-14-D-00332	
		13. Type of Report and Period Covered Final Report January 2020 to May 2020	
12. Sponsoring Agency Name and Address National Highway Traffic Safety Administration New Car Assessment Program 1200 New Jersey Avenue S.E. Washington, DC 20590		14. Sponsoring Agency Code NRM-110	
		15. Supplemental Notes	
16. Abstract An NCAP Dynamic Rollover Maneuver (Fishhook) Test was conducted on a 2020 Hyundai Palisade SEL FWD at Dynamic Research, Inc. on January 28, 2020. The vehicle did not experience two-wheel lift. The vehicle's steering angle at 0.3 g lateral acceleration at 50 mph was 31.1 degrees.			
17. Key Words New Car Assessment Program Rollover Fishhook Test		18. Distribution Statement Copies of this report are available from: NHTSA Technical Reference Division National Highway Traffic Safety Administration 1200 New Jersey Avenue, SE Washington, DC 20590	
19. Security Classif. (of this report) Unclassified	20. Security Classif. (of this page) Unclassified	21. Number of Pages 55	22. Price

TABLE OF CONTENTS

	Page
I. INTRODUCTION.....	1
II. VEHICLE PREPARATION	2
A. Test Vehicle	2
B. Tires	2
C. Vehicle Loading.....	2
D. Steering Controller	5
E. Real-Time Controller and Data Acquisition	5
F. Equipment Weight.....	5
G. Sensors	6
H. Other Vehicle Preparation	6
III. TEST PROCEDURES.....	9
A. Test Procedure Overview.....	9
B. Test Conditions	10
IV. RESULTS.....	13
APPENDIX A Photographs	A-1
APPENDIX B Test Run Log.....	B-1
APPENDIX C Slowly Increasing Steer Test Worksheet.....	C-1
APPENDIX D Time History Plots	D-1

LIST OF FIGURES

	Page
1. Nominal Position of Video Cameras for Fishhook Tests	8
2. DRI-Minter Vehicle Dynamics Area	12

LIST OF TABLES

	Page
1. Test Vehicle Data	3
2. Tire Information	4
3. Vehicle Loading	4
4. Weight of In-Cab Test equipment.....	6
5. Sensor Specifications	7
6. Surface Friction	10
7. Handwheel Angles	10
8. Weather Conditions.....	11

Section I
INTRODUCTION

Beginning with the 2006 fiscal year, the National Highway Traffic Safety Administration (NHTSA) has engaged Dynamic Research, Inc. (DRI) of Torrance, CA to conduct dynamic rollover testing and gather data from that testing as part of NHTSA's New Car Assessment Program (NCAP).

The purpose of the testing reported herein was to determine if a typical 2020 Hyundai Palisade SEL FWD would experience tip-up, defined as simultaneous two-wheel lift of two inches or more at an entry speed of 50 mph or less in the Fishhook Procedure developed by NHTSA. This procedure may be found at www.regulations.gov, docket item NHTSA-2006-26555-0136.

The testing reported herein was accomplished under contract DTNH22-14-D-00332. The task order is entitled, "NCAP Dynamic Rollover Testing."

Section II
VEHICLE PREPARATION

A. Test Vehicle

The test vehicle was new or in as-new condition, meaning the vehicle had been driven no more than 500 miles prior to the start of dynamic rollover testing. It was acquired through a commercial rental/leasing company. Details of the test vehicle are given in Table 1.

B. Tires

All tires used were new, and of the same make, model, size, and DOT specification of those installed on the vehicle when purchased new. Tire inflation pressures were in accordance with the recommendations indicated on each vehicle's identification placard. To further reduce the possibility of tire debanding, the tires were mounted to the rims without the use of tire mounting lubricant. Tire specifications are listed in Table 2.

C. Vehicle Loading

The multi-passenger load, described in the Fishhook Procedure, was used for all tests. The load and positioning of the load in the vehicle are listed in Table 3.

In addition to water dummies, the loading included instrumentation, a steering machine, and outriggers. Test vehicle bumper assemblies were removed for outrigger installation. The reduction in vehicle weight due to the removal of the bumpers was offset by the additional weight of the outriggers and their mounting system. The outrigger system typically outweighs the bumper assemblies.

Table 1. Test Vehicle Data

General Data					
Model year, make, model	2020 Hyundai Palisade SEL FWD				
VIN	KM8R24HEXLU10xxxx				
Vehicle type/Body style	MPV/SUV				
Number of doors	4				
Trim level	SEL				
Seating positions	Front:	2 nd row	3 rd row	4 th row	5 th row
	2	2	3		
Electronic stability control	Yes				
4-Wheel ABS (Yes/No)	Yes				
Power steering (Yes/No)	Yes				
Major optional equipment	Sun Roof Option				
Odometer at start of testing	15 miles				
Drivetrain					
Engine cylinder arrangement	V-6				
Engine displacement	3.8 L				
Transmission type	Automatic				
Drive arrangement	2WD (FWD)				
Chassis					
Track width	F: 66 in (1676.4 mm), R: 67 in (1701.8 mm)				
Wheelbase	114.38 in (2905.3 mm)				
Curb weight	4170 lb (1891.5 kg)				
Certification Data from Vehicle's Label					
Vehicle manufactured by	Hyundai Motor Company				
Date of manufacture	Dec/02/19				
GVWR	5732 lb (2600 kg)				
GAWR Front	2954 lb (1340 kg)				
GAWR Rear	3197 lb (1450 kg)				

Table 2. Tire Information

Tire Manufacturer	Bridgestone
Tire Model	Dueler H/P Sport A/S
Tire Size	Front: 245/60R18 Rear: 245/60R18
Load rating	Front:105 Rear:105
Speed rating	Front: H Rear: H
Treadwear grade	Front: 400 Rear: 400
Traction grade	Front: A Rear: A
Temperature grade	Front: B Rear: B
Location of "Recommended Tire Pressure" label	Driver's door jamb
Recommended cold tire pressure	Front: 35 psi, (240 kPa) Rear: 35 psi, (240 kPa)
First 8 digits of DOT code	Front: EJ L2 CEC Rear: EJ L2 CEC

Table 3. Vehicle Loading

Water dummy and other loading	3 water dummies - 2 in second row, 1 in center of third row
Water dummy weight	525 lb (238.1 kg)
Fuel level	Full
Weight as Tested	
Left front	1380 lb (626 kg)
Right front	1311 lb (594.7 kg)
Left rear	1257 lb (570.2 kg)
Right rear	1216 lb (551.6 kg)

D. Steering Controller

Precise controlled steering is accomplished using a steering machine designed and constructed by DRI. DRI has used its Automated Vehicle Controller (AVC) steering machine for many vehicle tests including FMVSS 126 tests. It can provide up to 65 ft-lb torque and rates over 1300 deg/sec. The integrated angle encoder has an unlimited range with a resolution of 0.045 degrees and an accuracy of ± 0.045 degrees. The steering motor is controlled by a MicroAutoBox II from dSPACE, which also acts as the data acquisition system.

E. Real-Time Controller and Data Acquisition

Data acquisition is achieved using a MicroAutoBox II from dSPACE, which also serves as the real-time system for the steering controller. Data from the Oxford IMU, including Longitudinal, Lateral, and Vertical Acceleration, Roll, Yaw, and Pitch Rate, Forward and Lateral Velocity, Roll and Pitch Angle, are sent over Ethernet to the Micro AutoBox. The Oxford IMUs are calibrated per the manufacturer's recommended schedule (Table 5). The MicroAutoBox II specifications are:

Model: dSPACE Micro-Autobox II 1401/1513
Base Board SN 549068
I/O Board SN 588523

Two video cameras were used to record the Fishhook runs. They were positioned nominally as shown in Figure 1. The recorded videotapes were reviewed after the Fishhook runs to check for any two-wheel lift. If any two-wheel lift was observed, eight infrared distance- measuring sensors for measurement of wheel lift (two sensors at each wheel) were then mounted for use in subsequent confirmation Fishhook tests.

F. Equipment Weight

Table 4 lists the equipment and associated weights outlined in the NHTSA Laboratory Test Procedure for Dynamic Rollover and the equipment at DRI used for this specific test program. The equipment used at DRI for this test program differs slightly from the equipment that was previously used by NHTSA for rollover testing. Because DRI's equipment is lighter than NHTSA's equipment, DRI uses ballast to maintain a consistent weight and weight distribution in the vehicle.

Table 4. Weight of In-Cab Test Equipment

Equipment	Location	Equipment Weight (lb)	
		NHTSA*	DRI
Data Acquisition System	Front passenger seat	58	
Steering Machine	Handwheel	31	31
Steering Machine Electronics Box	Passenger row foot well behind the front passenger seat. If vehicle does not have a rear passenger row foot well, the Electronics Box should be placed in the front passenger seat foot well.	39	
MABX, and laptop	Front passenger seat		21
Motor control and power supply	Front passenger footwell		26
Ballast	Front passenger footwell		50
Total		128	128

* Table A.1 from US DOT NHTSA - Laboratory Test Procedure for Dynamic Rollover - The Fishhook Maneuver Test Procedure - New Car Assessment Program (NCAP) - March 2013

G. Sensors

A list of the sensors is given in Table 5.

H. Other Vehicle Preparation

In addition to installation and preparation discussed above, the test vehicle was prepared as follows:

- Front and rear bumpers were removed
- Outrigger mounts were installed in the bumper locations and titanium outriggers were fastened to these mounts
- Airbags were removed or otherwise disabled
- Photographs of the vehicle tested are given in Appendix A.

Table 5. Sensors

Measured Variable	Sensor	Range	Resolution	Accuracy	Specifics	Serial Number	Calibration
Vehicle Tire Pressure	Tire Pressure Gauge	0-100 psi 0-690 kPa	0.01 psi 6.89 kPa	< 1% error between 20 and 100 psi	Omega DPG8001	17042707002	By: DRI Date: 7/3/2019 Due: 7/3/2020
Vehicle Total, Wheel, and Axle Load	Platform Scales (Minter)	1200 lb/platform 5338 N/platform	1 lb 4.4 N	0.5% of applied load	Intercomp SWI	1110M206352	By: DRI Date: 1/6/2020 Due: 1/6/2021
	Platform Scales (Torrance)	1200 lb/platform 5338 N/platform	1 lb 4.4 N	0.5% of applied load	Intercomp SW500	0828MA19001	By: DRI Date: 9/12/2019 Due: 9/12/2020
Handwheel Angle	Steering Angle Encoder (Automated Steering Controller)	±800 deg	0.045 deg	±0.045 deg	DRI Automatic Vehicle Controller using dSPACE Micro-Autobox II	NA	Verified by DRI at installation ¹
Longitudinal, Lateral, and Vertical Acceleration Roll, Yaw, and Pitch Rate, Forward and Lateral Velocity, Roll and Pitch Angle	Multi-Axis Inertial Sensing System	Accels ± 5 g, Angular Rate ±300 deg/s, Angle >45 deg, Velocity >200 km/h	Accels .001 g, Angular Rate 0.01 deg/s, Angle 0.05 deg, Velocity 0.1 km/h	Accels .001g, Angular Rate 0.01 deg/s, Angle 0.05 deg, Velocity 0.1 km/h	Oxford xNav 550	015386	By: Oxford Technical Solutions Date: 8/8/2019 Due: 8/8/2021

1 . The steering encoder is checked prior to beginning tests to verify that there are no faults. The steering controller is installed in the vehicle and the steering wheel is turned through two complete revolutions while recording data. The data are then reviewed for any dropouts or other nonlinearities that would indicate dust intrusion or faulty sectors.

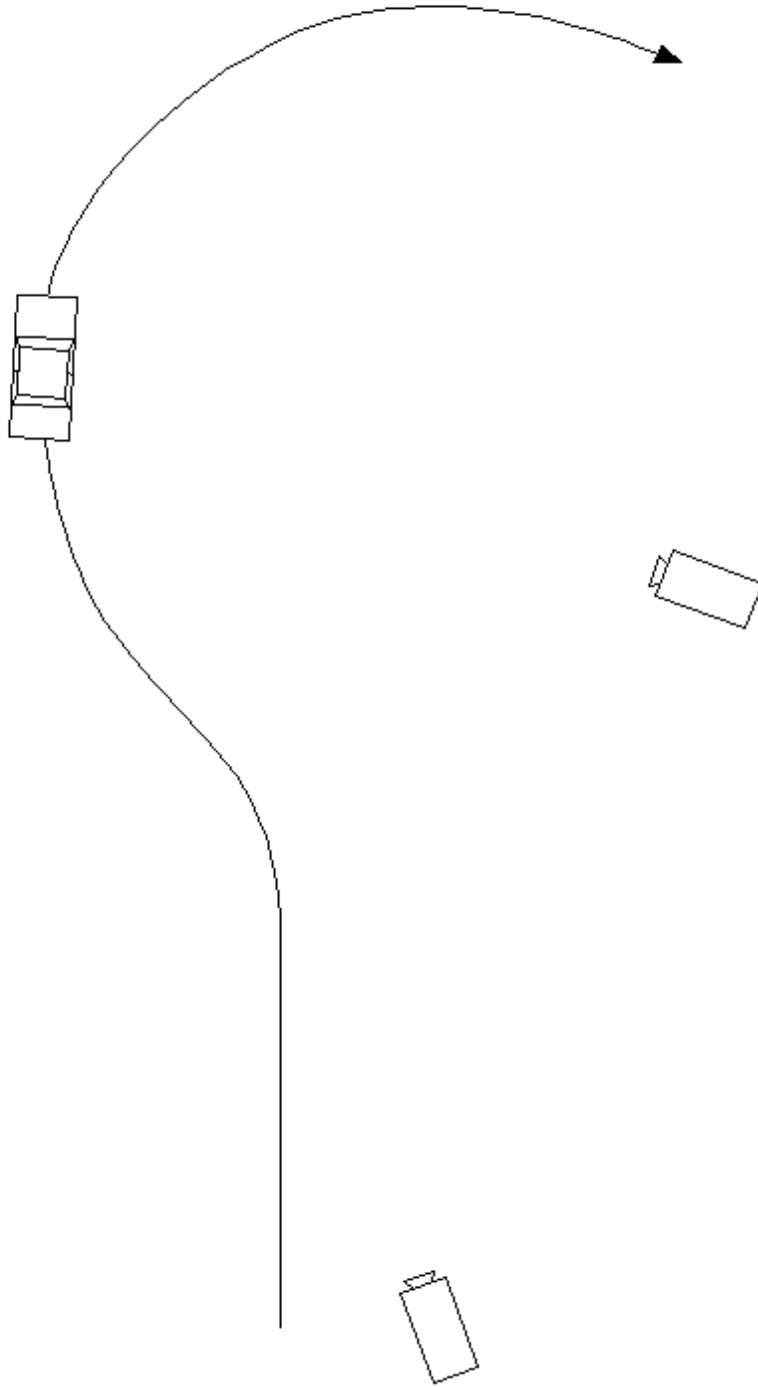

Figure 1. Nominal Position of Video Cameras for Fishhook Tests

Section III

TEST PROCEDURES

This section includes a general overview of the test procedures and details of the particular test.

A. Test Procedure Overview

This test was conducted in accordance with NHTSA's NCAP Rollover Resistance Test Procedure (Fishhook) as described in the Federal Register (68 FR 59250). Detailed descriptions of the test procedure, pass/fail criteria, and data acquisition specifications may be found at docket NHTSA-2001-9663.

There are two major components of the test procedure, the Slowly Increasing Steer (SIS) pre-test and the Fishhook test.

The Slowly Increasing Steer (SIS) maneuver was used to characterize the steady state lateral dynamics of each vehicle, and is based on the "Constant Speed, Variable Steer" test defined in SAE J266. The maneuver is used to determine the handwheel angle that produces a lateral acceleration of 0.3 g at 50 mph. This handwheel angle is then used to determine the magnitude of steering to be used for the NHTSA Fishhook maneuver.

SIS tests were performed at a constant speed of 50 mph. Handwheel angle was input at a rate of 13.5 deg/sec, from 0 to an angle that provided at least 0.55 g. Three tests were conducted in each direction, and the data for the six runs were averaged to obtain the handwheel angle that produced 0.3 g at 50 mph.

The Fishhook test is a programmed steering maneuver that is implemented via the steering controller. The vehicle was initially steered in one direction and then the steering was reversed. The timing, magnitude, and rate of the steering were prescribed by the Fishhook Procedure.

To begin the maneuver, the vehicle was driven in a straight line at a speed slightly greater than the desired entrance speed. The driver then released the throttle. When the vehicle was at the target speed, the steering controller automatically initiated the steering maneuver. Following completion of the steering reversal, the handwheel position was maintained for three seconds and then returned to zero angle in 1 second.

The tests were conducted in both left-right and right-left directions. The "Default" test series used a handwheel angle equal to 6.5 times the handwheel angle that produced 0.3 g at 50 mph in the SIS tests, and initial vehicle speeds beginning at 35 mph and concluding up to 50 mph (if no two-wheel lift occurs). Supplemental tests were also done, as specified in the Fishhook Procedure.

B. Test Conditions

1. TEST SURFACE

The tests were conducted on the Vehicle Dynamics Area at DRI's Minter Field facility, located near Bakersfield, California, on 1/28/2020. The VDA has a smooth, flat (slope less than 0.5% throughout) asphaltic concrete surface. Its dimensions are as shown in Figure 2. It was built in the spring of 2005.

VDA surface friction measurements were accomplished using the DRI Mobile Tire Tester. Three runs were done, one at each of three previously determined locations. Each run provided for a minimum of 3 seconds of tire friction at constant normal load, slip angle, and speed in a free rolling condition. The test was accomplished using an ASTM E1136 tire with an inflation pressure of 35 (± 0.5) psi at a test speed of 40 (± 0.5) mph. The net slip angle of the test tire for each test run was 7.5 deg. The test tire was no older than 6 months from the date of manufacture. The surface friction measurement results are shown in Table 6.

Table 6. Surface Friction

Date of surface friction measurements	1/31/2020
Average normalized lateral force	0.793

2. FISHHOOK HANDWHEEL ANGLES

The 0.3 g handwheel angle obtained from the SIS tests and the handwheel angles used in the Fishhook tests are shown in Table 7.

Table 7. Handwheel Angles

0.3 g handwheel angle (from SIS tests at 50 mph)	31.1°
5.5 scalar handwheel angle for Fishhook Test	171°
6.5 scalar handwheel angle for Fishhook Test	202°

3. WEATHER CONDITIONS

The weather conditions, recorded at the end of testing, are shown in Table 8.

Table 8. Weather Conditions

Ambient temperature	51.8° F (11° C)
Wind Speed	3.5 mph (1.3 m/s)
Wind Direction	NE

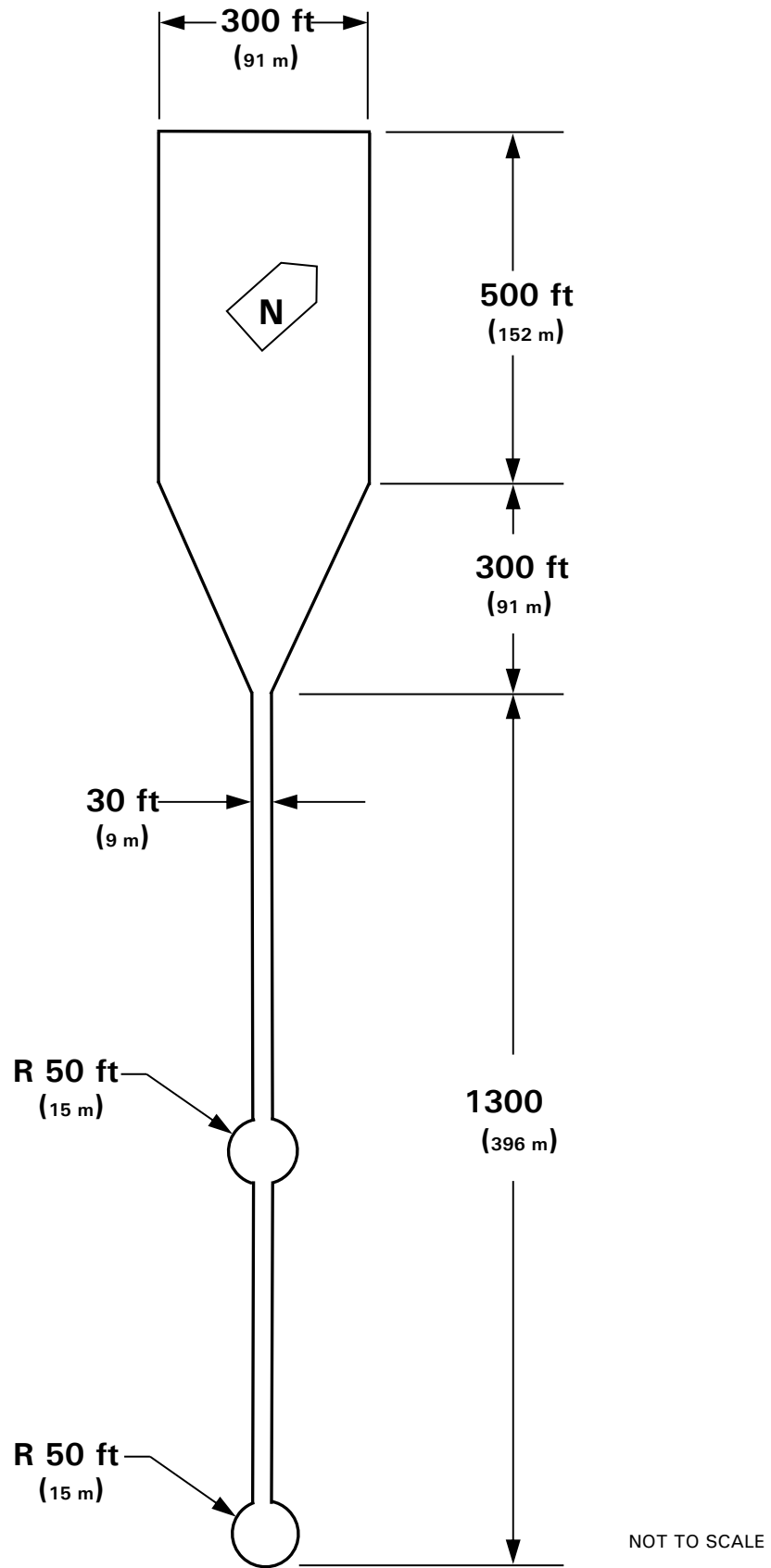

Figure 2. DRI-Minter Vehicle Dynamics Area

Section IV

RESULTS

The test run log is given in Appendix B. The Slowly Increasing Steer Test Worksheet is given in Appendix C. Appendix D contains time history plots for the 50 mph runs and any runs which resulted in two-wheel lift. There was no two-wheel lift at any test condition for the 2020 Hyundai Palisade SEL FWD.

APPENDIX A

Photographs

LIST OF FIGURES

	Page
A1. Window Sticker.....	A-3
A2. Front View, Test Vehicle as Delivered	A-4
A3. Rear View, Test Vehicle as Delivered	A-5
A4. Front View, Test Vehicle in Test Condition	A-6
A5. Rear View, Test Vehicle in Test Condition	A-7
A6. Certification Label.....	A-8
A7. Tire Placard	A-9
A8. Instrumentation in Test Vehicle	A-10
A9. Steering Controller and Computer	A-11
A10. Ballast Condition.....	A-12

VIN: KM8R24HEXLU10



Affix FULL Label to driver side Left-Rear.



2020 PALISADE SEL FWD

<p>SOLD TO: _____</p> <p>SHIPPED TO: _____</p> <p>VIN: KM8R24HEXLU10 MODEL: J1442F65 ENGINE: G6DNKA3198 PORT OF ENTRY: HU EXTERIOR COLOR: BECKETTS BLACK INTERIOR/SEAT COLOR: BLACK/BLACK TRANSPORT: TRUCK ACCESSORY WEIGHT: 18 lbs./ 8 kgs. EMISSIONS: This vehicle is certified to meet emission requirements in all 50 states</p>	<p>GOVERNMENT 5-STAR SAFETY RATINGS</p> <p>Overall Vehicle Score ★ ★ ★ ★ ★ <small>Based on the combined rating of frontal, side and rollover. Should ONLY be compared to other vehicles of similar size and weight.</small></p> <hr/> <p>Frontal Driver ★ ★ ★ ★ ★ Crash Passenger ★ ★ ★ ★ ★ <small>Based on the risk of injury in a frontal impact. Should ONLY be compared to other vehicles of similar size and weight.</small></p> <hr/> <p>Side Front seat ★ ★ ★ ★ ★ Crash Rear seat ★ ★ ★ ★ ★ <small>Based on the risk of injury in a side impact.</small></p> <hr/> <p>Rollover ★ ★ ★ ★ ★ <small>Based on the risk of rollover in a single-vehicle crash.</small></p> <p>Star ratings range from 1 to 5 stars (★★★★★) with 5 being the highest. Source: National Highway Traffic Safety Administration (NHTSA). www.safercar.gov or 1-888-327-4236</p>
<p>STANDARD FEATURES:</p> <p>AMERICA'S BEST WARRANTY 5-year/60,000-mile New Vehicle Warranty* INCLUDED 10-year/100,000-mile Powertrain Warranty* INCLUDED 7-year/Unlimited-mile Anti-perforation Warranty* INCLUDED 5-year/Unlimited-mile Roadside Assistance INCLUDED *Limited warranties, see dealer for details</p> <p>ADVANCED SAFETY TECHNOLOGY Vehicle Stability Management w/ ESC & TCS INCLUDED ABS w/ Electronic Brake-Force Distribution & Brake Assist INCLUDED Shift-By-Wire; Electric Parking Brake INCLUDED Front, Front Side Impact, Side-Curtain & Driver's Knee Airbag INCLUDED Tire Pressure Monitoring System & Rearview Camera INCLUDED Forward Collision-Avoidance Assist with Ped. Detection INCLUDED Lane Keeping Assist; Driver Attention Warning INCLUDED Rear Occupant Alert; Rear Parking Distance Warning INCLUDED Blind-Spot Collision-Avoidance Assist; Safe Exit Assist INCLUDED Rear Cross-Traffic Collision-Avoidance Assist INCLUDED</p> <p>POWERTRAIN TECHNOLOGY 3.8L GDI V6 Engine w/ Idle Stop & Go; 291 HP / 262 lb-ft Torque INCLUDED 8-Speed Automatic Transmission w/ SHIFTRONIC® paddle shifters INCLUDED Drive Mode Select knob INCLUDED</p> <p>EXTERIOR 18" Alloy Wheels & 245/60 R18 Tires; Satin Chrm ext dr handles INCLUDED LED Daytime Running Lights; High Beam Assist with auto on/off INCLUDED Heated Dual Power Side Mirrors w/ turn signal indicators INCLUDED Solar Front Glass & Privacy Rear Glass; Roof Side Rails INCLUDED Trailer pkg (pre-wiring, transmission cooler, sway control) INCLUDED</p> <p>COMFORT & CONVENIENCE 8-inch Display Audio w/ Android Auto(TM) & Apple CarPlay(TM) INCLUDED Captain's chairs; Prox key w/ push button start & immobilizer INCLUDED Pwr windows w/ front row auto down/up; Pwr driver seat INCLUDED Rear Seat Quiet Mode; Bluetooth® Hands-free Phone System INCLUDED Front Heated Cloth Seats; One-touch 2nd row; Remote Engine Starter INCLUDED Front USB ports; 2nd row USB charging ports on seats INCLUDED Leather wrapped steering wheel w/ audio, cruise & phone controls INCLUDED Auto-dimming interior rearview mirror with HomeLink INCLUDED Dual auto temp control; 2nd row auto HVAC; Haptic steering whl INCLUDED Smart Cruise Control w/ Stop & Go; Lane Following Assist INCLUDED Full Tank of Fuel INCLUDED</p>	<p>Manufacturer's Suggested Retail Price: \$33,500.00</p> <p>ADDED FEATURES:</p> <p>*Sunroof Option \$900.00 Power Sunroof; LED interior/map lamps *Carpeted Floor Mats \$160.00 *Cargo Net \$50.00 *Cargo Cover \$190.00 *Rear Bumper Appliqué \$70.00</p> <p>Inland Freight & Handling : \$1,095.00 Total Price : \$35,965.00</p>

Figure A1. Window Sticker



Figure A2. Front View, Test Vehicle as Delivered



Figure A3. Rear View, Test Vehicle as Delivered



Figure A4. Front View, Test Vehicle in Test Condition



Figure A5. Rear View, Test Vehicle in Test Condition



Figure A6. Certification Label



TIRE AND LOADING INFORMATION
RENSEIGNEMENTS SUR LES PNEUS ET LE CHARGEMENT

SEATING CAPACITY NOMBRE DE PLACES	TOTAL 7	FRONT AVANT 2	REAR ARRIÈRE 5
--------------------------------------	---------	------------------	-------------------

The combined weight of occupants and cargo should never exceed 532 kg or 1173 lbs.
Le poids total des occupants et du chargement ne doit jamais dépasser 532 kg ou 1173 lb.

TIRE PNEU	SIZE DIMENSIONS	COLD TIRE PRESSURE PRESSION DES PNEUS À FROID
FRONT AVANT	245/60R18	240kPa, 35psi
REAR ARRIÈRE	245/60R18	240kPa, 35psi
SPARE DE SECOURS	T155/90R18	420kPa, 60psi

**SEE OWNER'S
MANUAL FOR
ADDITIONAL
INFORMATION**
**VOIR LE MANUEL
DE L'USAGER
POUR PLUS DE
RENSEIGNEMENTS**

C04

Figure A7. Tire Placard

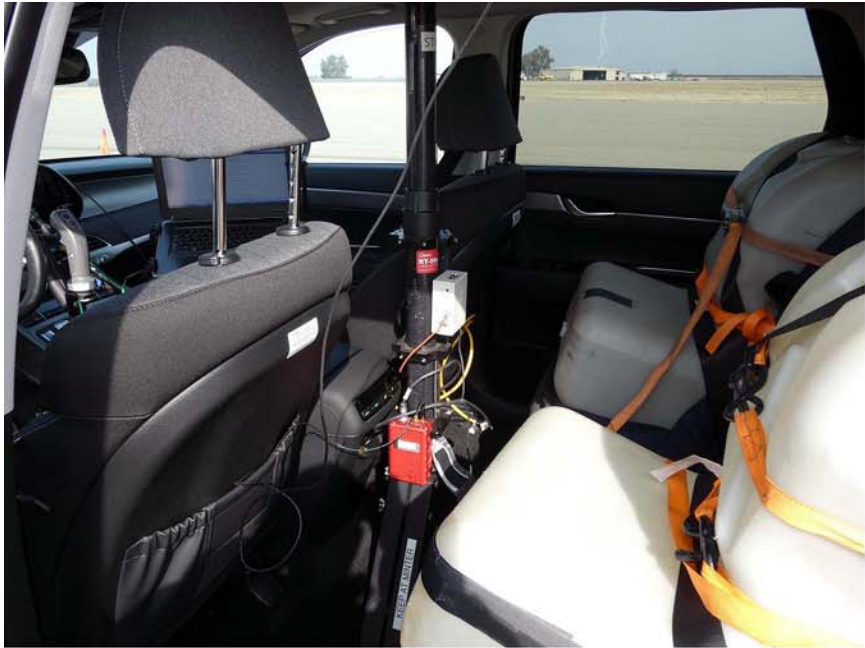

Figure A8. Instrumentation in Test Vehicle



Figure A9. Steering Controller and Computer



Figure A10. Ballast Condition

APPENDIX B

Test Run Log

Vehicle: **2020 Hyundai Palisade SEL FWD**

Driver: **Stephen Rhim**

Test Date: **1/28/2020**

Run Number	Test Type	Speed (mph)	Handwheel Angle (deg)	Dir. of First Steer	2 Wheel Lift	Notes
1	Tire Warm-Up	35	60	Right	NA	
2	"	"	70	"	"	
3	"	"	"	"	"	
4	"	"	"	"	"	
5	2x SWA last cycle	"	"	"	"	
6	Static	0	0			
7	Steady State	50	0			
8	Slowly Increasing Steer	50	50	Left	NA	
9	"	"	"	Left	"	
10	"	"	"	Left	"	
11	"	"	"	Right	"	
12	"	"	"	Right	"	
13	"	"	"	Right	"	

Run Number	Test Type	Speed (mph)	Handwheel Angle (deg)	Dir. of First Steer	2 Wheel Lift	Notes
14	6.5 Scalar Fishhook	35	202	Left	N	
15	"	40	"	"	"	
16	"	45	"	"	"	
17	"	47.5	"	"	"	
18	"	50	"	"	"	
19	5.5 Scalar Fishhook	45	171	Left	No	
20	"	47.5	"	"	"	
21	"	50	"	"	"	
22	6.5 Scalar Fishhook	35	202	Right	No	
23	"	40	"	"	"	
24	"	45	"	"	"	
25	"	47.5	"	"	"	
26	"	50	"	"	"	
27	5.5 Scalar Fishhook	45	171	Right	No	
28	"	47.5	"	"	"	

Run Number	Test Type	Speed (mph)	Handwheel Angle (deg)	Dir. of First Steer	2 Wheel Lift	Notes
29	"	50	"	"	"	

APPENDIX C

Slowly Increasing Steer Test Worksheet

NCAP, 2020 Hyundai Palisade SEL FWD, Multi-Passenger Load, Test Date: 1/28/2020

SIS_out_v2

Run	Dir of Steer	Start Speed (mph)	End Speed (mph)	Speed Red. (%)	Index of ay @ 0.3g	HW Angle (deg) at 0.3g	ay (g) @ 0.3g index	6.5x HW Angle (deg)	Ramp Time (sec) at 6.5x	5.5x HW Angle (deg)	Ramp Time (sec) at 5.5x	R2	Zero Begin Index	Zero End Index
8	L	49.9	0.0	100.0	1271	-31.3	-0.306	-203.7	-0.2829	-172.3	-0.2393	0.9991	600	800
9	L	49.9	0.0	100.0	1274	-31.5	-0.303	-204.9	-0.2846	-173.4	-0.2408	0.9994	600	800
10	L	50.0	0.1	99.8	1272	-31.4	-0.306	-204.0	-0.2833	-172.6	-0.2397	0.9988	600	800
11	R	50.2	0.1	99.8	1264	30.8	0.309	200.4	0.2783	169.5	0.2355	0.9958	600	800
12	R	50.0	1.4	97.1	1259	30.6	0.304	198.6	0.2759	168.1	0.2334	0.9956	600	800
13	R	50.0	3.0	93.9	1264	30.9	0.301	200.9	0.2790	170.0	0.2361	0.9966	600	800

Mean: 31.1 0.305 202 0.281 171 0.237

Steering Controller Input Values

Scalar 6.5 values:

Initial HW angle: 202 deg
 Initial time: 0.281 s
 Reversal HW angle: -202 deg
 Reversal time: 0.561 s

Scalar 5.5 values:

Initial HW angle: 171 deg
 Initial time: 0.237 s
 Reversal HW angle: -171 deg
 Reversal time: 0.475 s

APPENDIX D

Time History Plots

LIST OF FIGURES

	Page
D1. Vehicle Speed, Handwheel Angle, and Roll Angle Time History Plots for Default Test Series, L-R, 50 mph	D-3
D2. Steering Machine Operation Time History Plots for Default Test Series, L-R, 50 mph.....	D-4
D3. Yaw Rate, Roll Rate, and Lateral Acceleration Time History Plots for Default Test Series, L-R, 50 mph	D-5
D4. Pitch Rate and Longitudinal Acceleration Time History Plots for Default Test Series, L-R, 50 mph	D-6
D5. Vehicle Speed, Handwheel Angle, and Roll Angle Time History Plots for Default Test Series, R-L, 50 mph	D-7
D6. Steering Machine Operation Time History Plots for Default Test Series, R-L, 50 mph	D-8
D7. Yaw Rate, Roll Rate, and Lateral Acceleration Time History Plots for Default Test Series, R-L, 50 mph	D-9
D8. Pitch Rate and Longitudinal Acceleration Time History Plots for Default Test Series, R-L, 50 mph	D-10
D9. Vehicle Speed, Handwheel Angle, and Roll Angle Time History Plots for Supplemental 2 Test Series, L-R, 50 mph.....	D-11
D10. Steering Machine Operation Time History Plots for Supplemental 2 Test Series, L-R, 50 mph.....	D-12
D11. Yaw Rate, Roll Rate, and Lateral Acceleration Time History Plots for Supplemental 2 Test Series, L-R, 50 mph.....	D-13
D12. Pitch Rate and Longitudinal Acceleration Time History Plots for Supplemental 2 Test Series, L-R, 50 mph.....	D-14
D13. Vehicle Speed, Handwheel Angle, and Roll Angle Time History Plots for Supplemental 2 Test Series, R-L, 50 mph.....	D-15
D14. Steering Machine Operation Time History Plots for Supplemental 2 Test Series, R-L, 50 mph.....	D-16
D15. Yaw Rate, Roll Rate, and Lateral Acceleration Time History Plots for Supplemental 2 Test Series, R-L, 50 mph.....	D-17
D16. Pitch Rate and Longitudinal Acceleration Time History Plots for Supplemental 2 Test Series, R-L, 50 mph.....	D-18

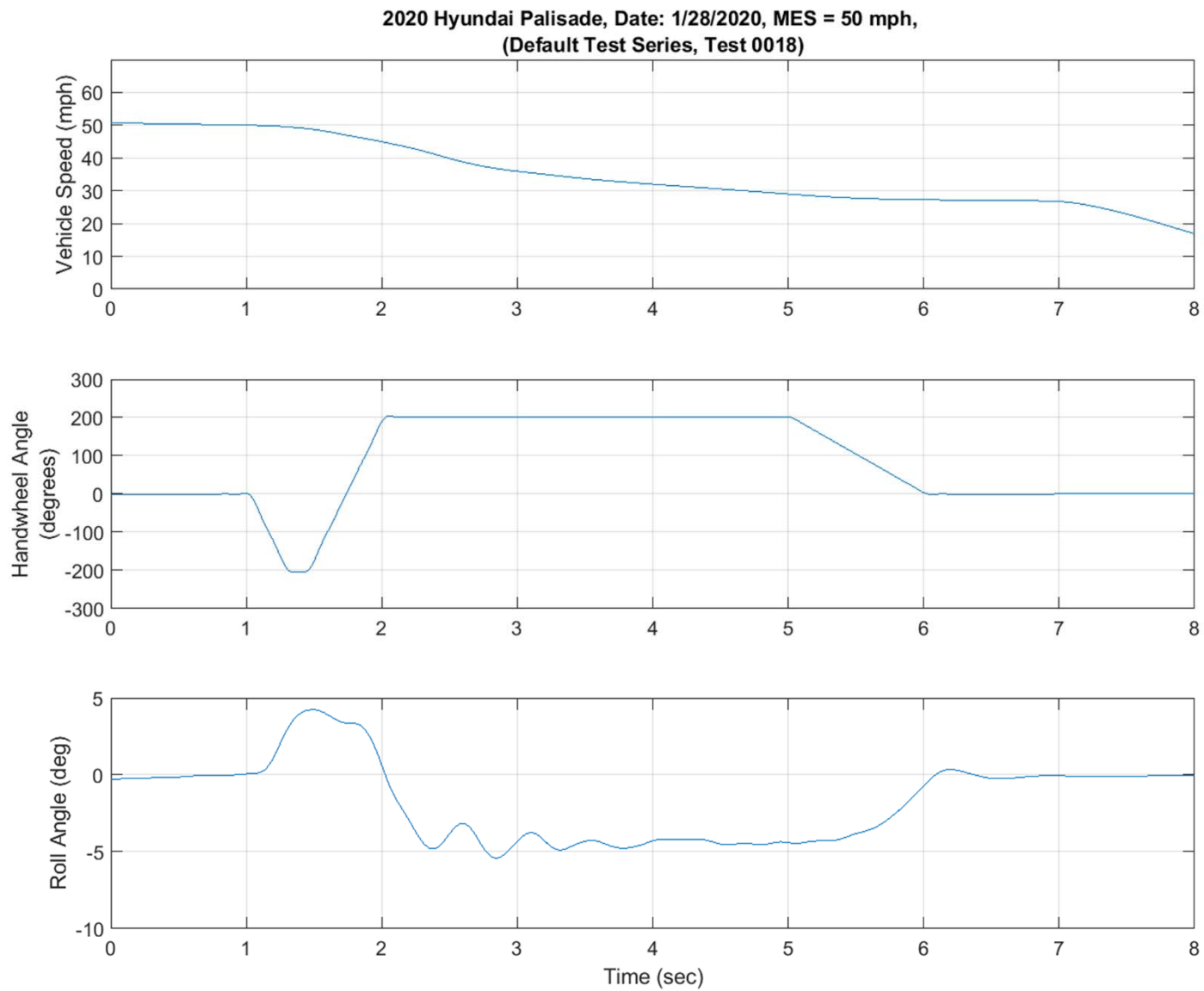

Figure D1. Vehicle Speed, Handwheel Angle, and Roll Angle Time History Plots for Default Test Series, L-R, 50 mph

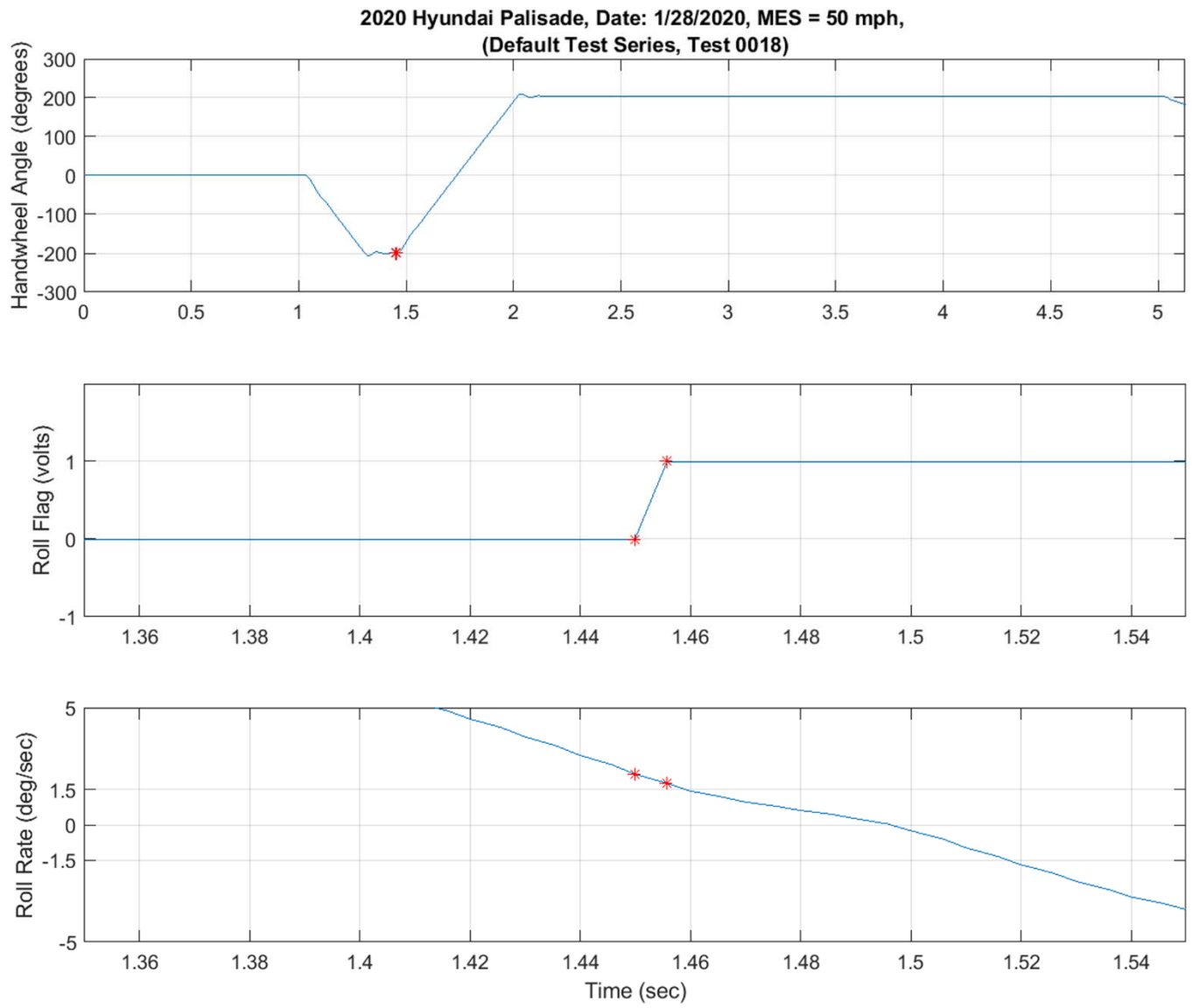

Figure D2. Steering Machine Operation Time History Plots for Default Test Series, L-R, 50 mph

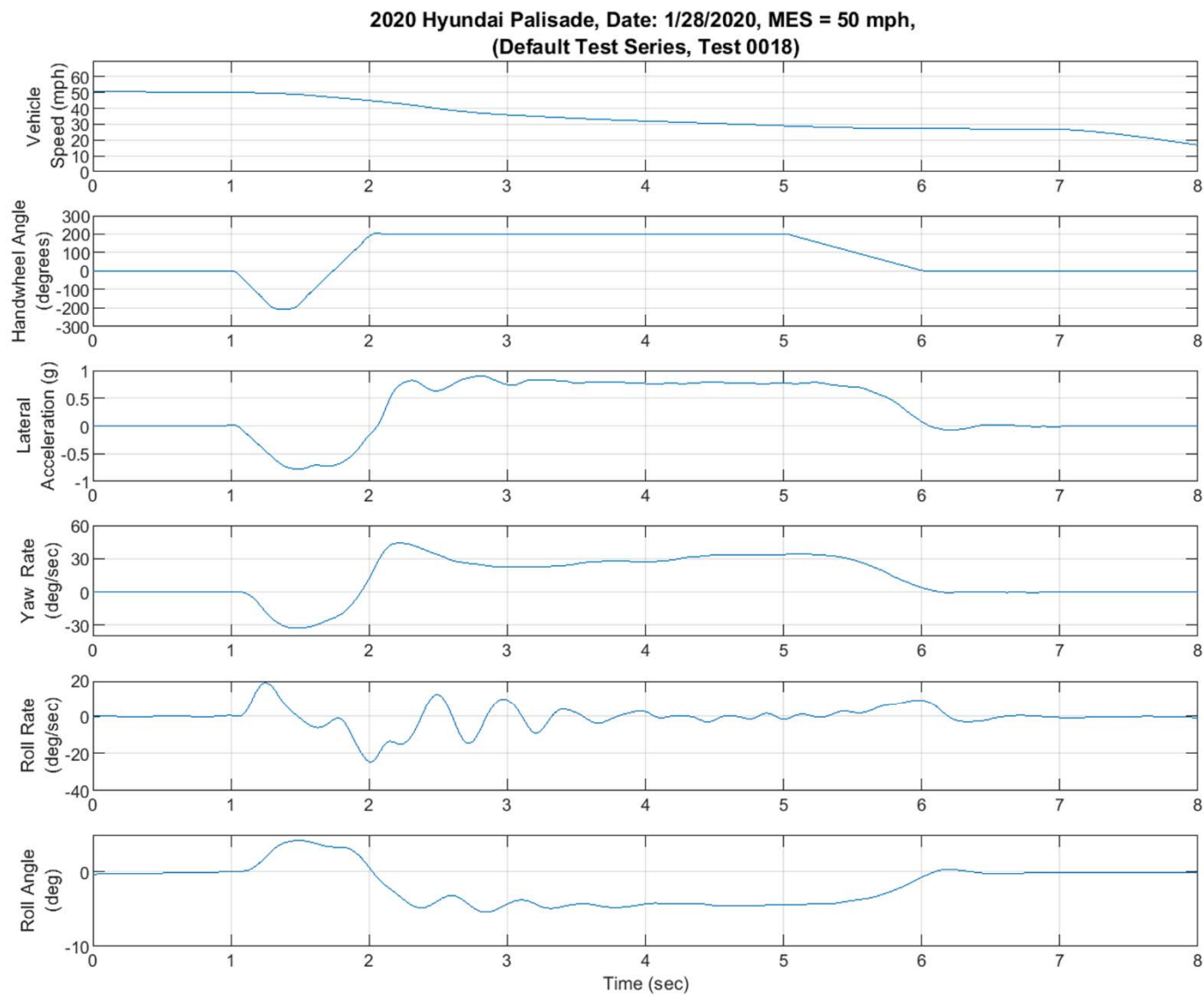

Figure D3. Yaw Rate, Roll Rate, and Lateral Acceleration Time History Plots For Default Test Series, L-R, 50 mph

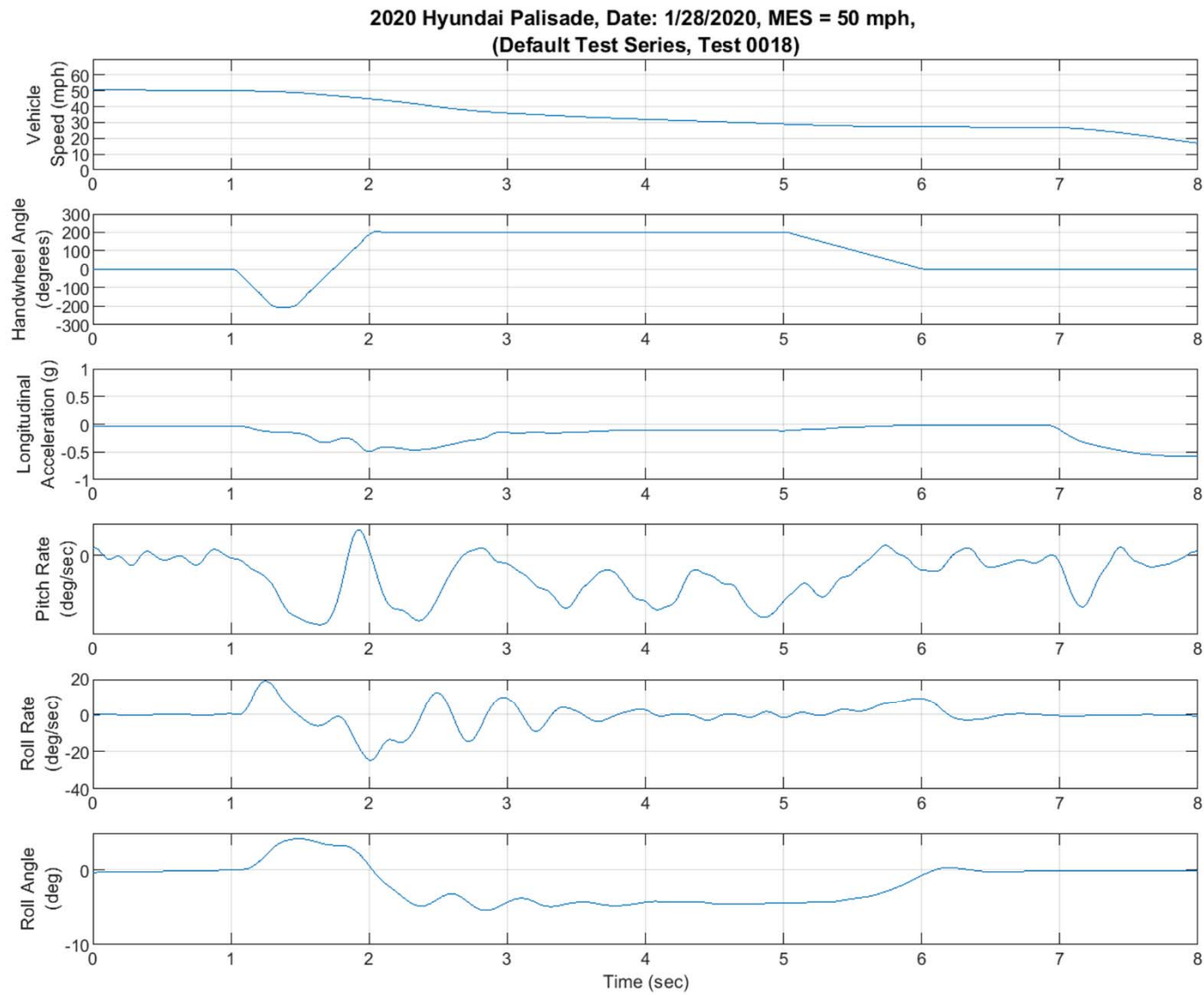

Figure D4. Pitch Rate and Longitudinal Acceleration Time History Plots for Default Test Series, L-R, 50 mph

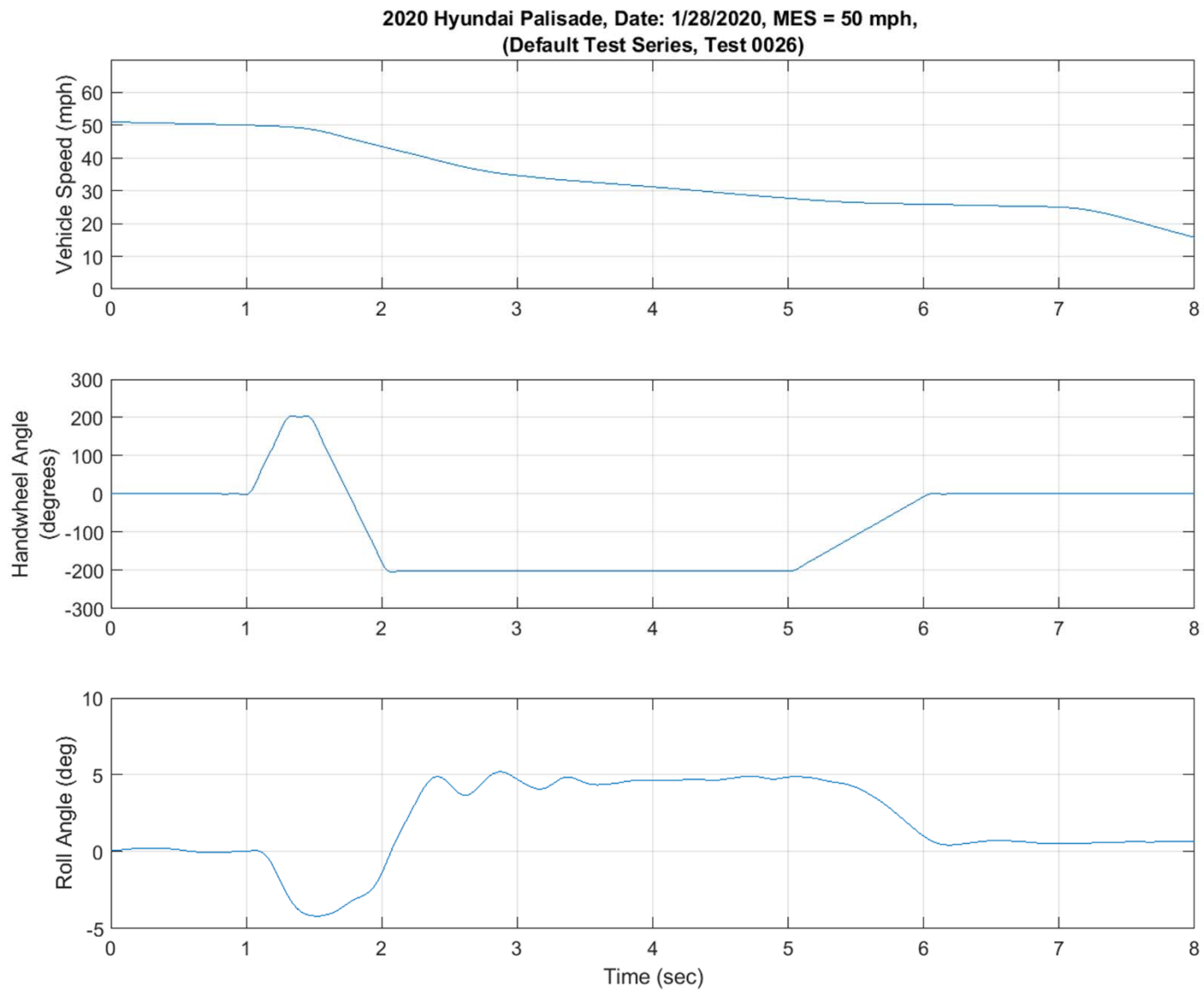

Figure D5. Vehicle Speed, Handwheel Angle, and Roll Angle Time History Plots for Default Test Series, R-L, 50 mph

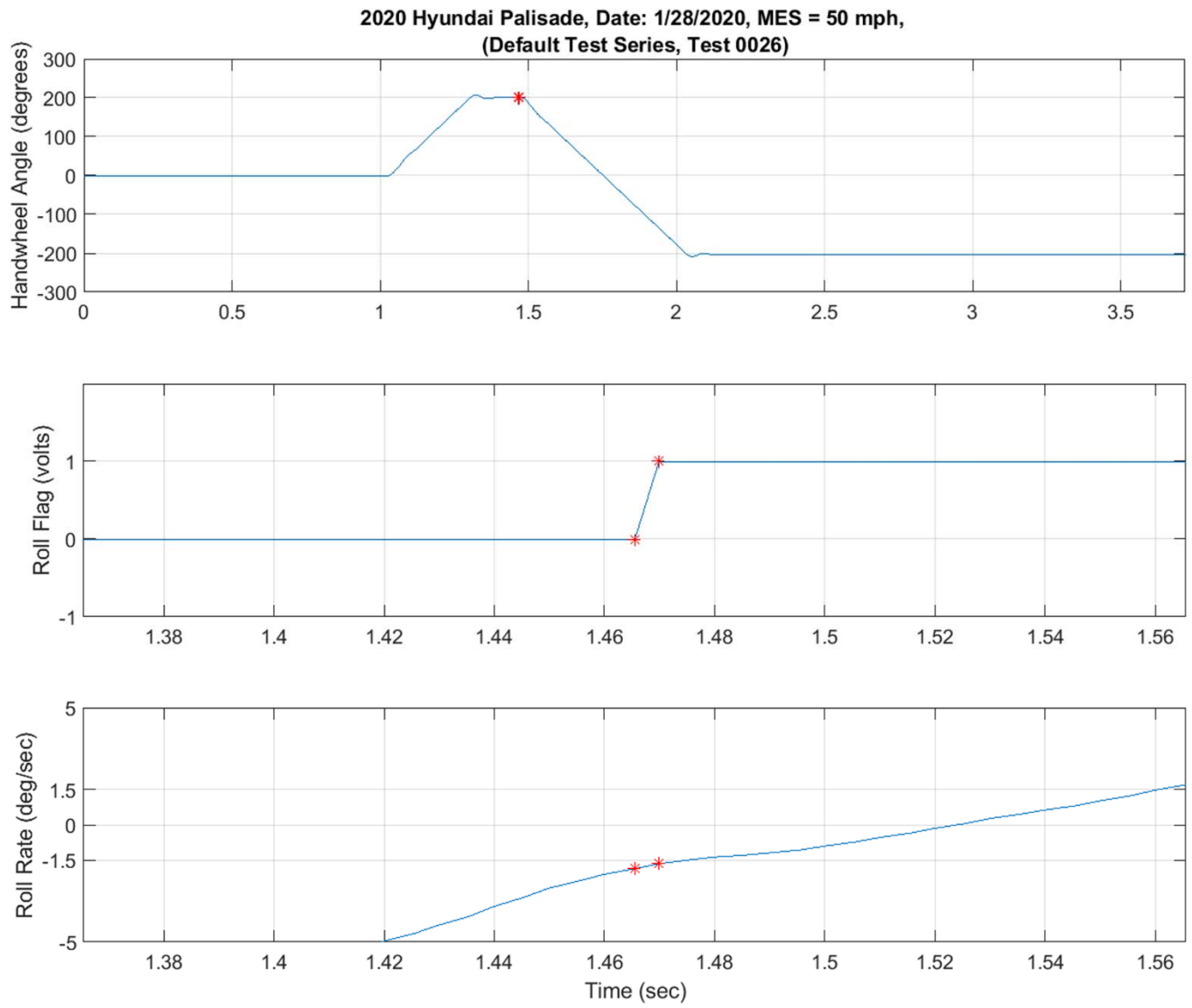

Figure D6. Steering Machine Operation Time History Plots for Default Test Series, R-L, 50 mph

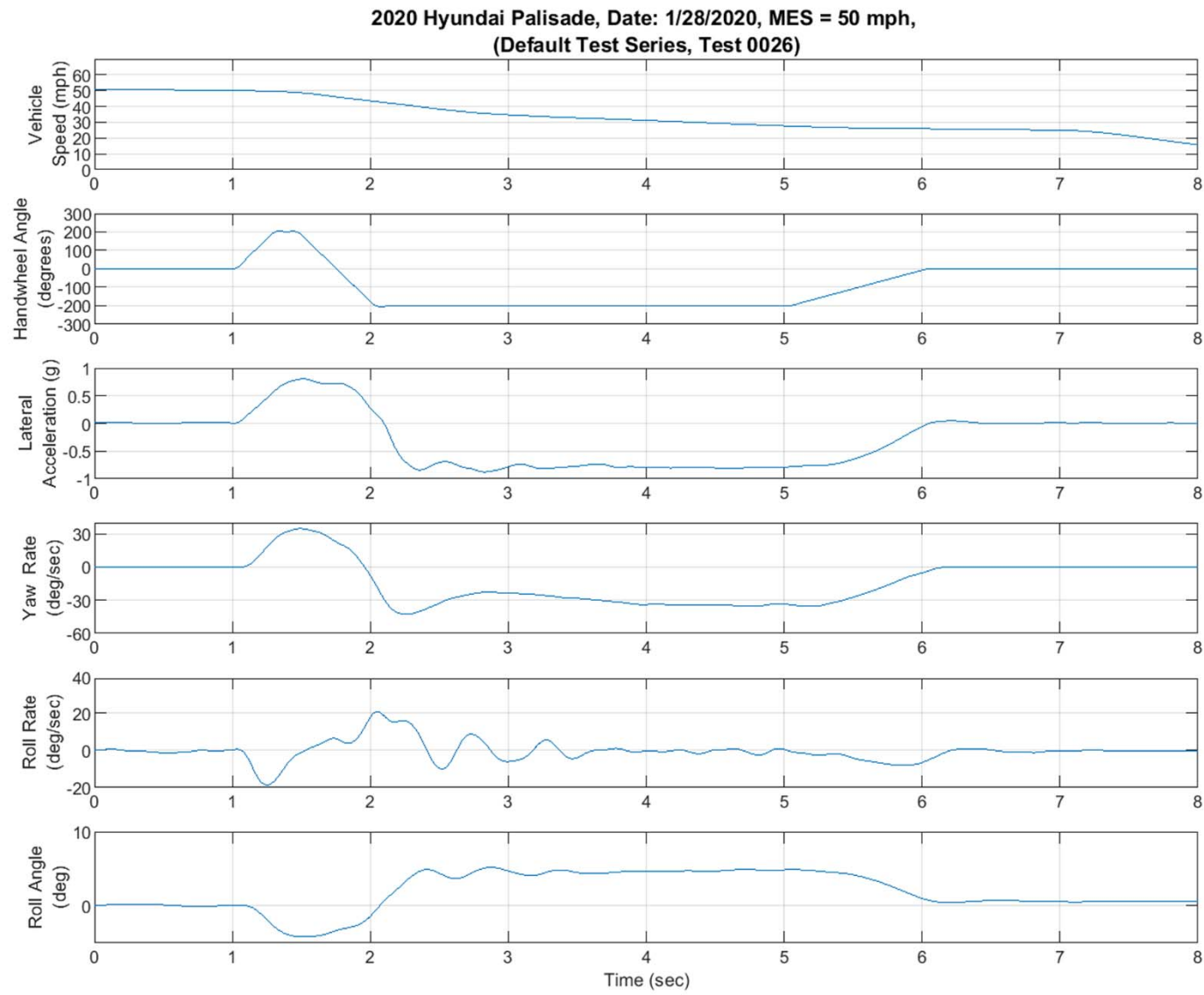

Figure D7. Yaw Rate, Roll Rate, and Lateral Acceleration Time History Plots for Default Test Series, R-L, 50 mph

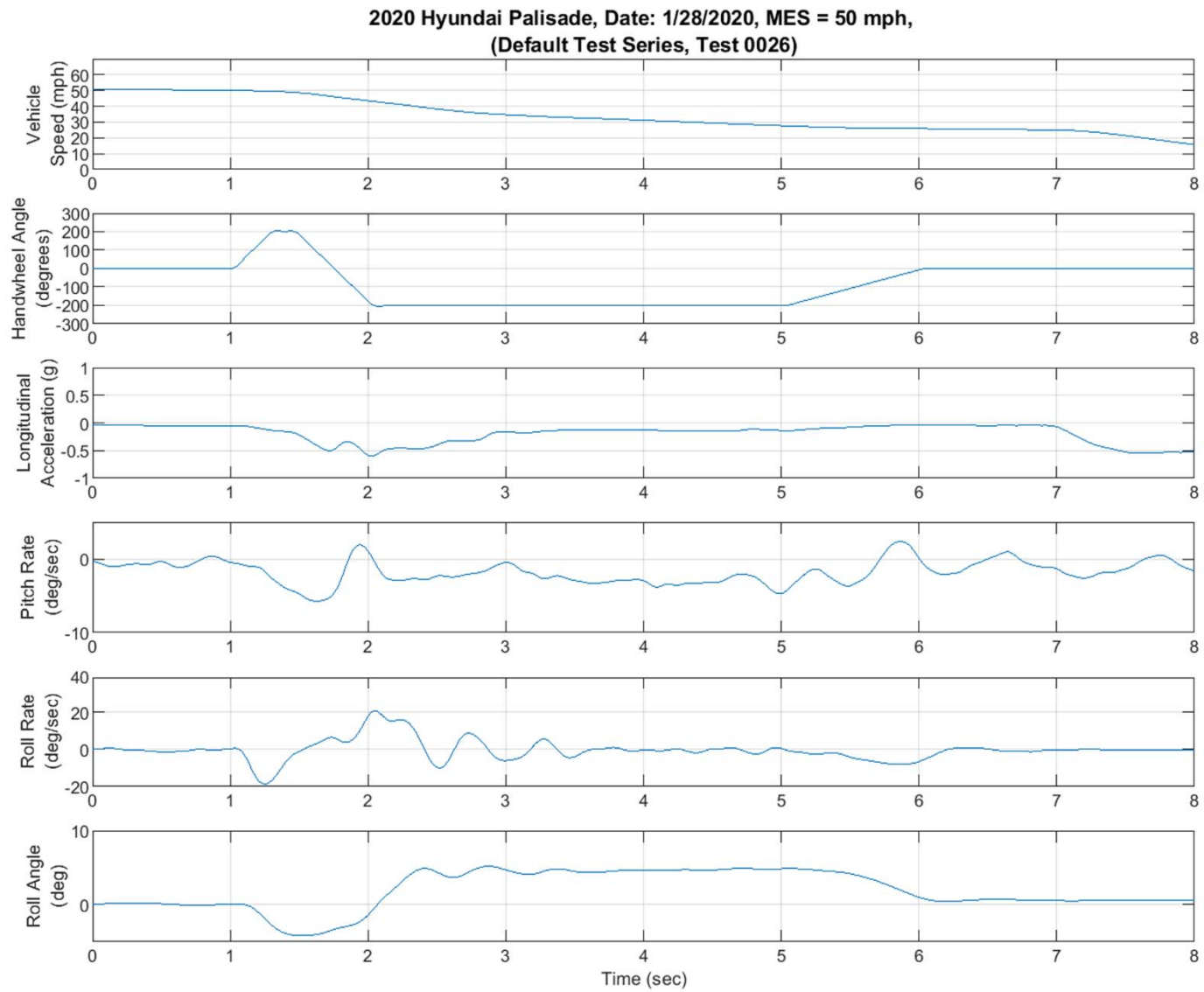

Figure D8. Pitch Rate and Longitudinal Acceleration Time History Plots or Default Test Series, R-L, 50 mph

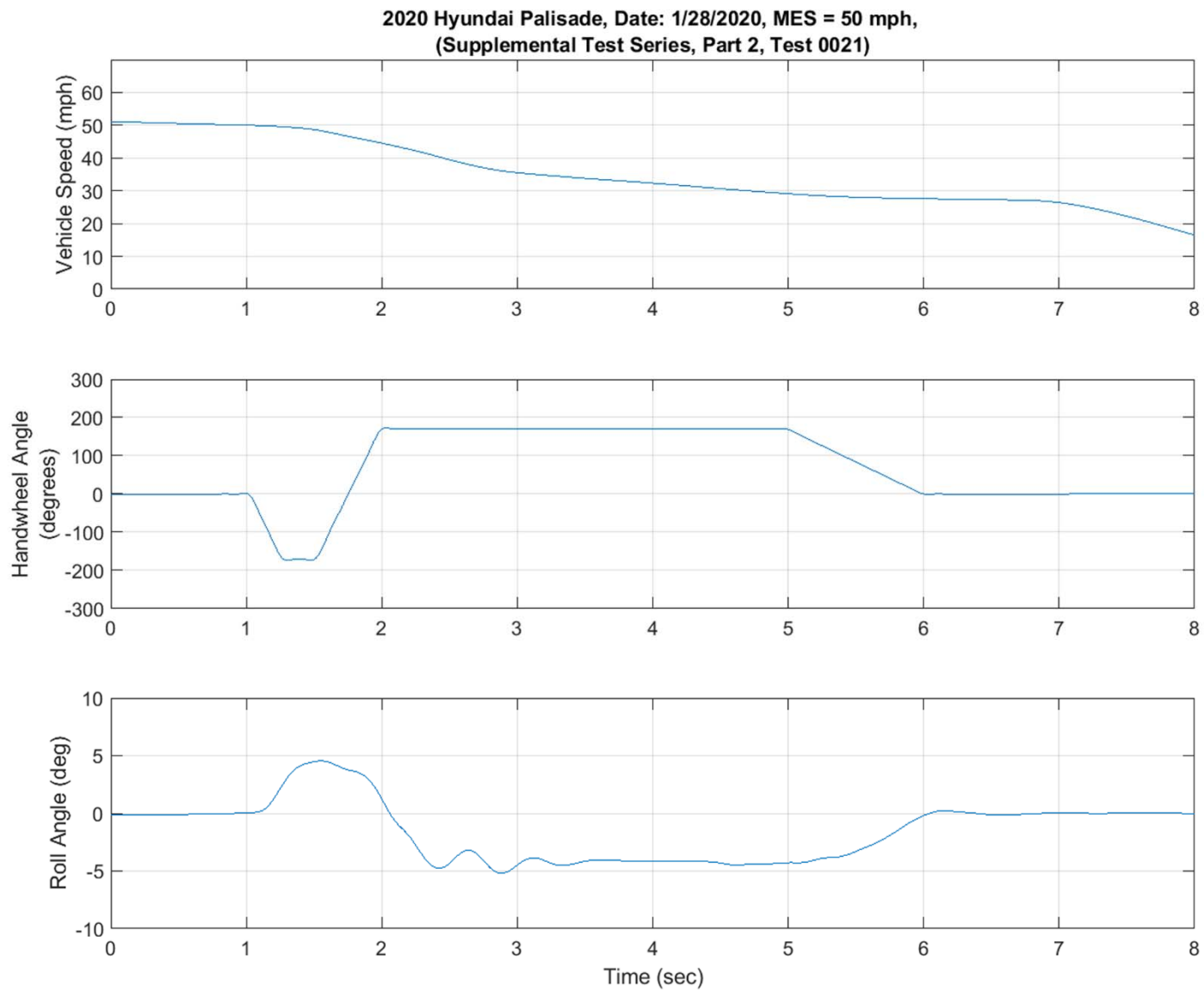

Figure D9. Vehicle Speed, Handwheel Angle, and Roll Angle Time History Plots for Supplemental 2 Test Series, L-R, 50 mph

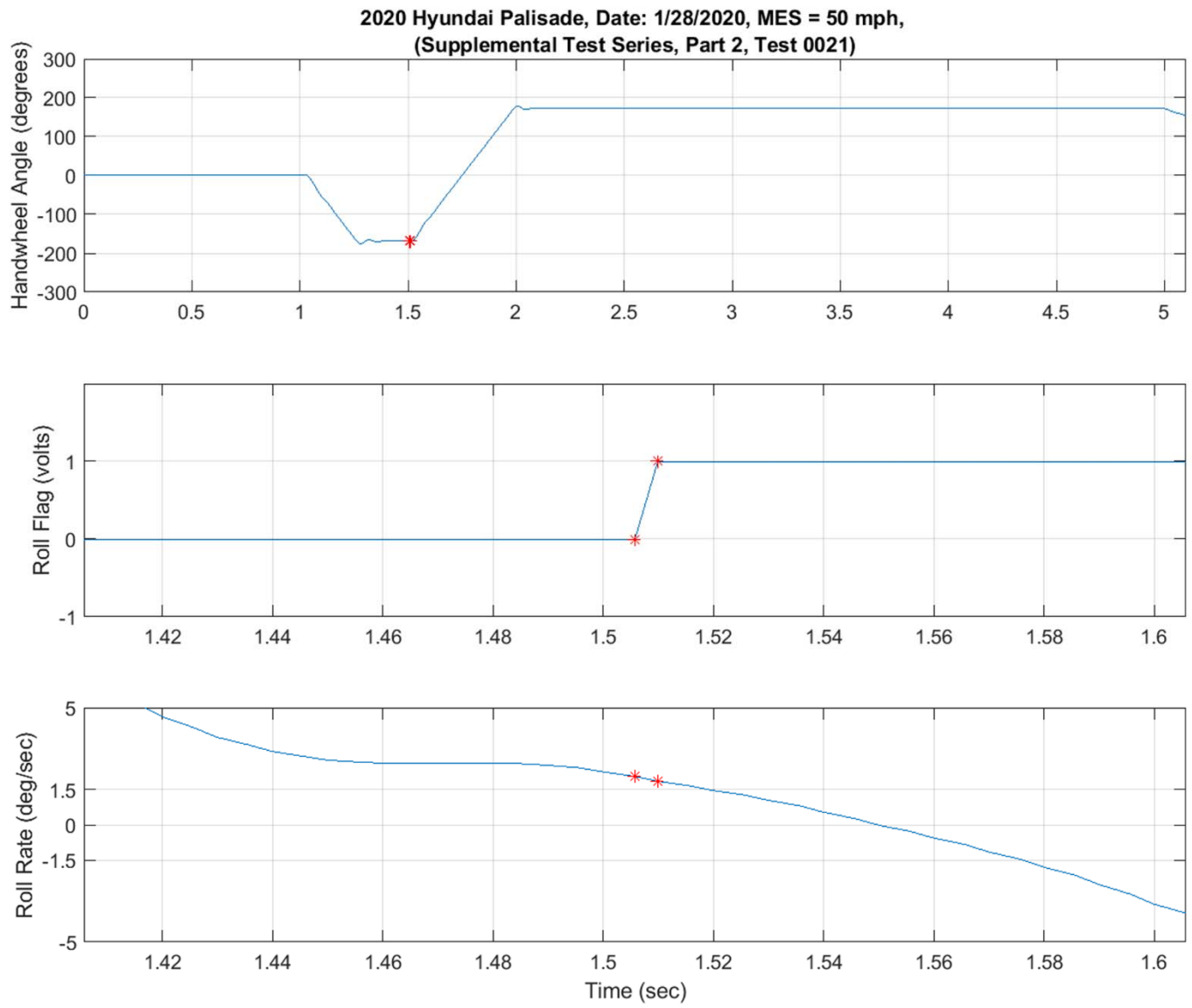

Figure D10. Steering Machine Operation Time History Plots for Supplemental 2 Test Series, L-R, 50 mph

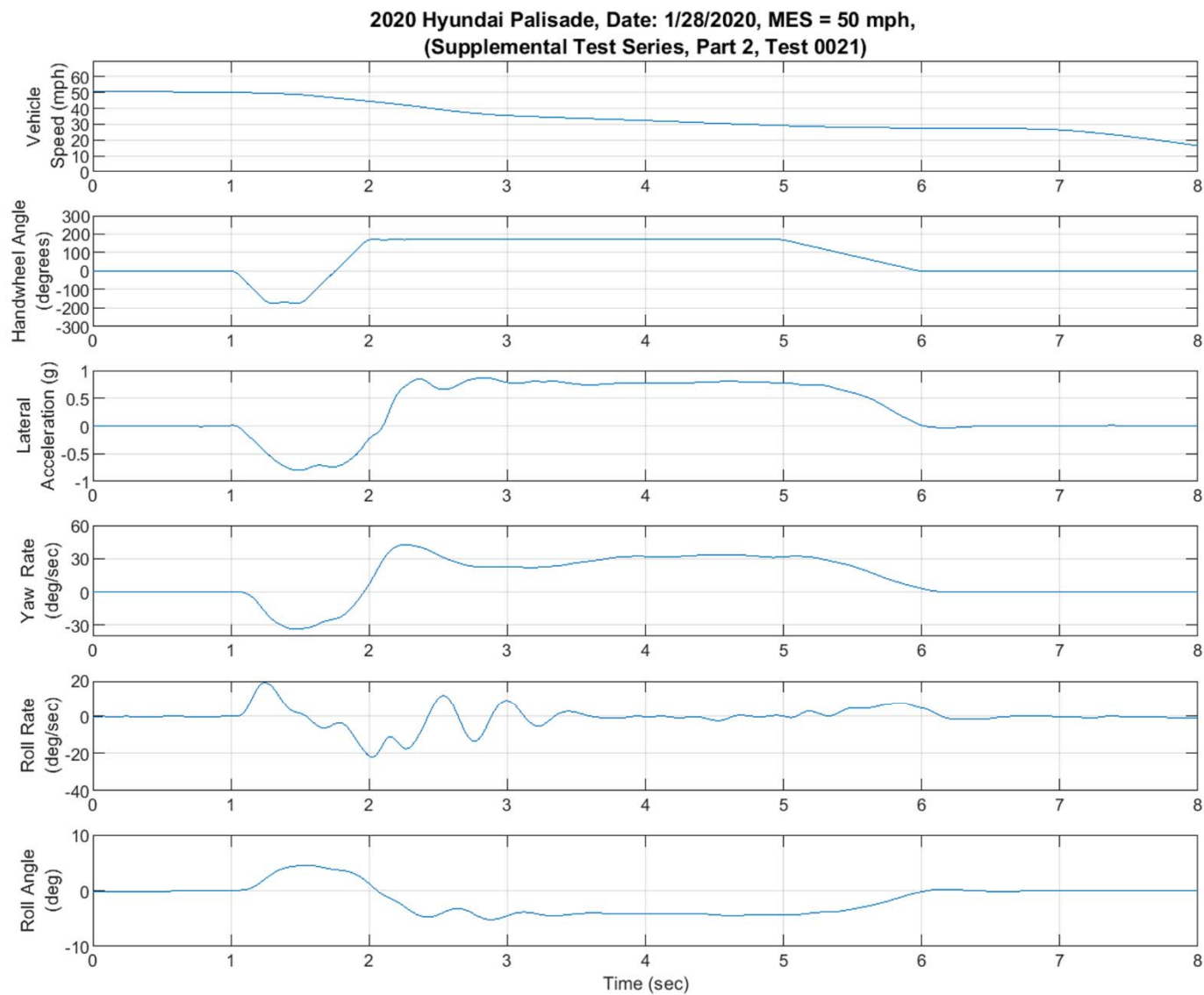

Figure D11. Yaw Rate, Roll Rate, and Lateral Acceleration Time History Plots for Supplemental 2 Test Series, L-R, 50 mph

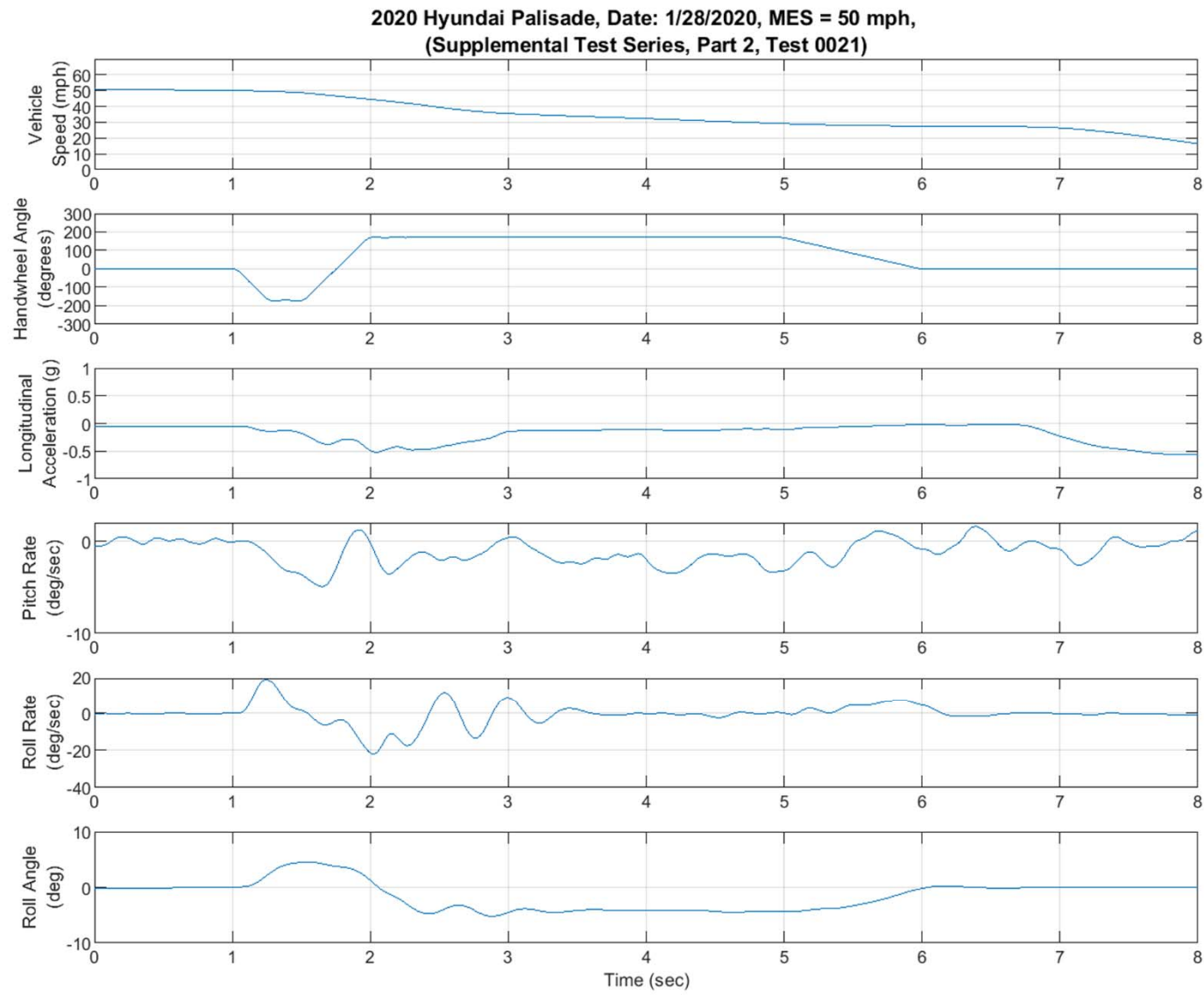

Figure D12. Pitch Rate and Longitudinal Acceleration Time History Plots for Supplemental 2 Test Series, L-R, 50 mph

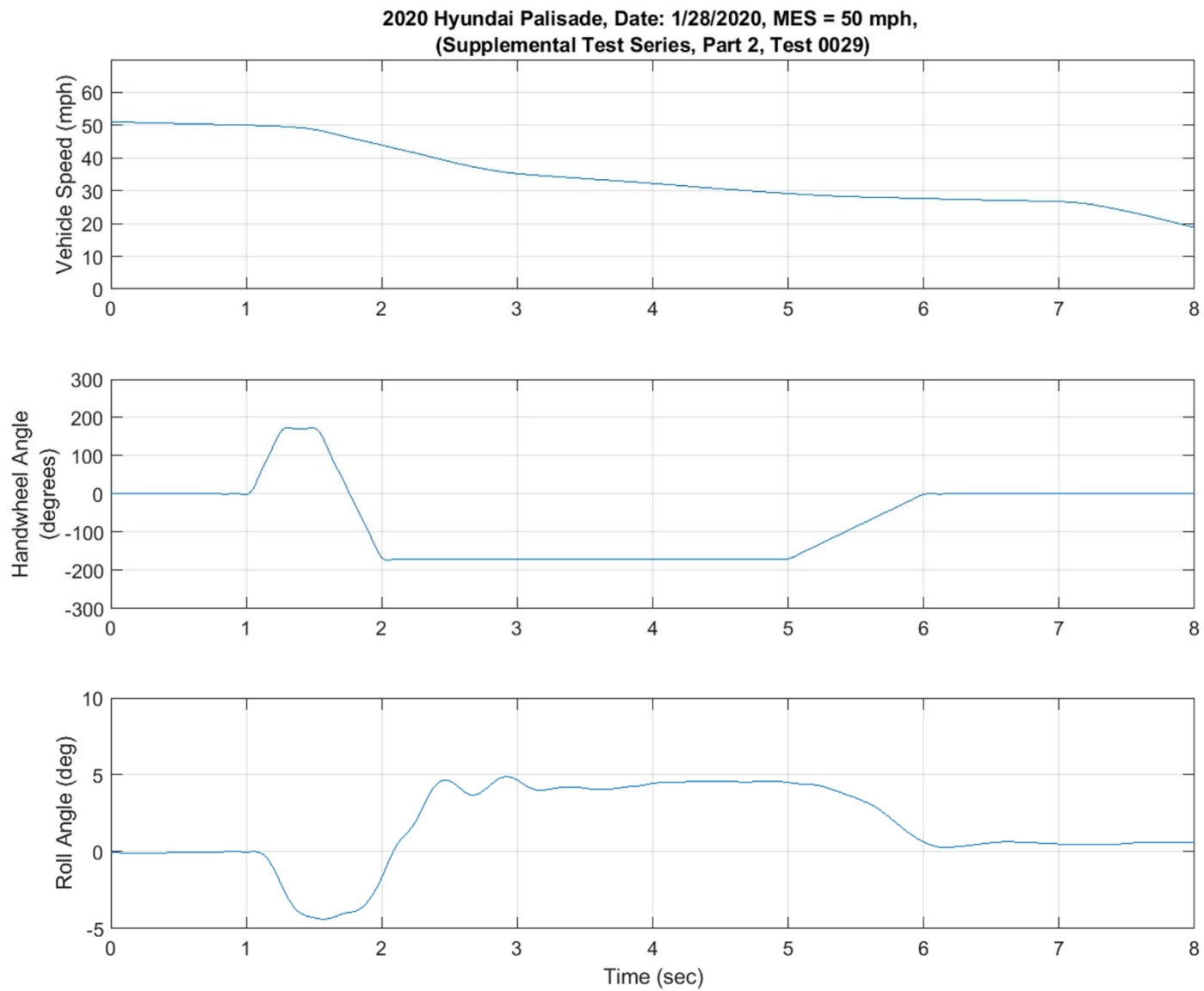

Figure D13. Vehicle Speed, Handwheel Angle, and Roll Angle Time History Plots for Supplemental 2 Test Series, R-L, 50 mph

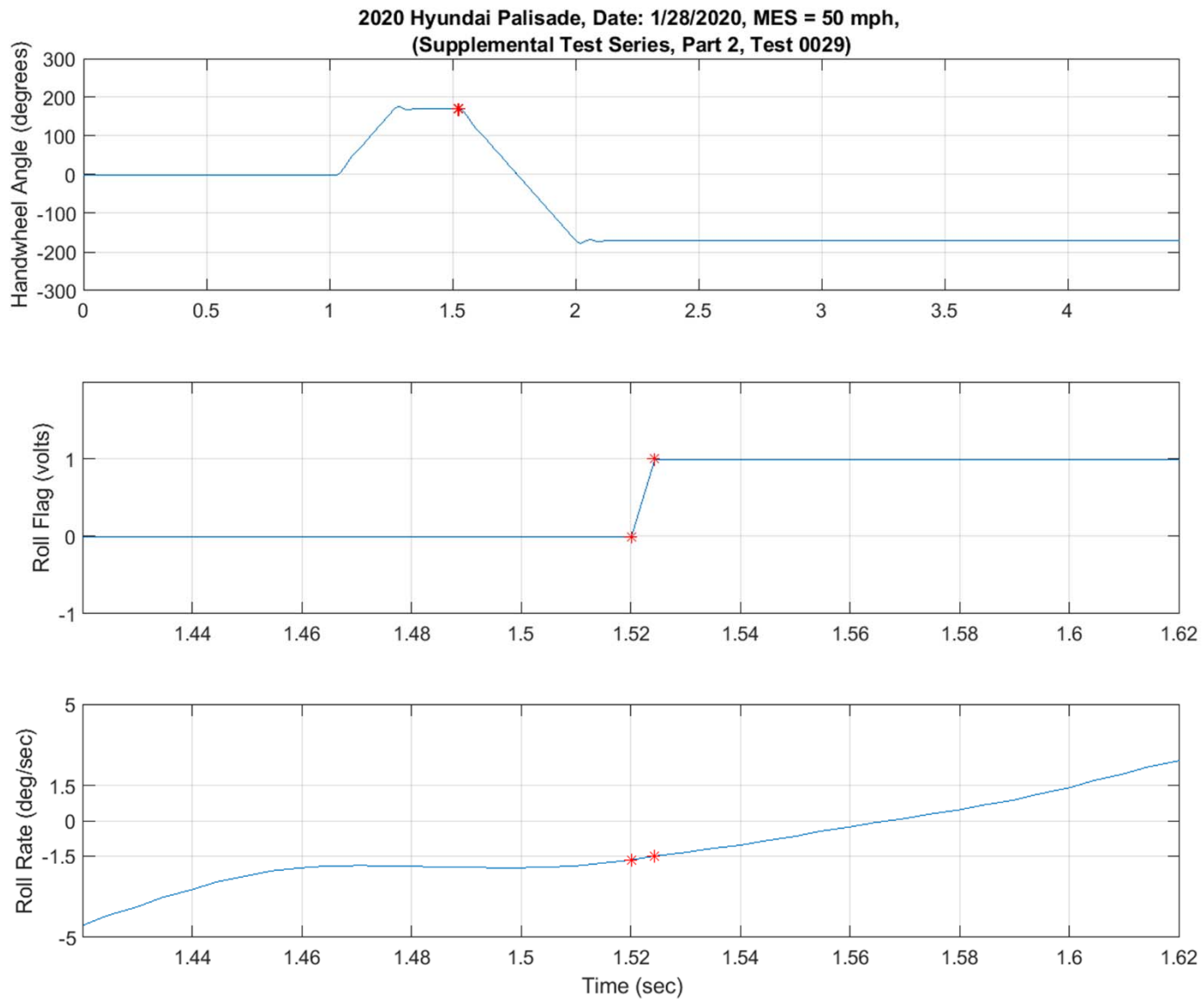

Figure D14. Steering Machine Operation Time History Plots for Supplemental 2 Test Series, R-L, 50 mph

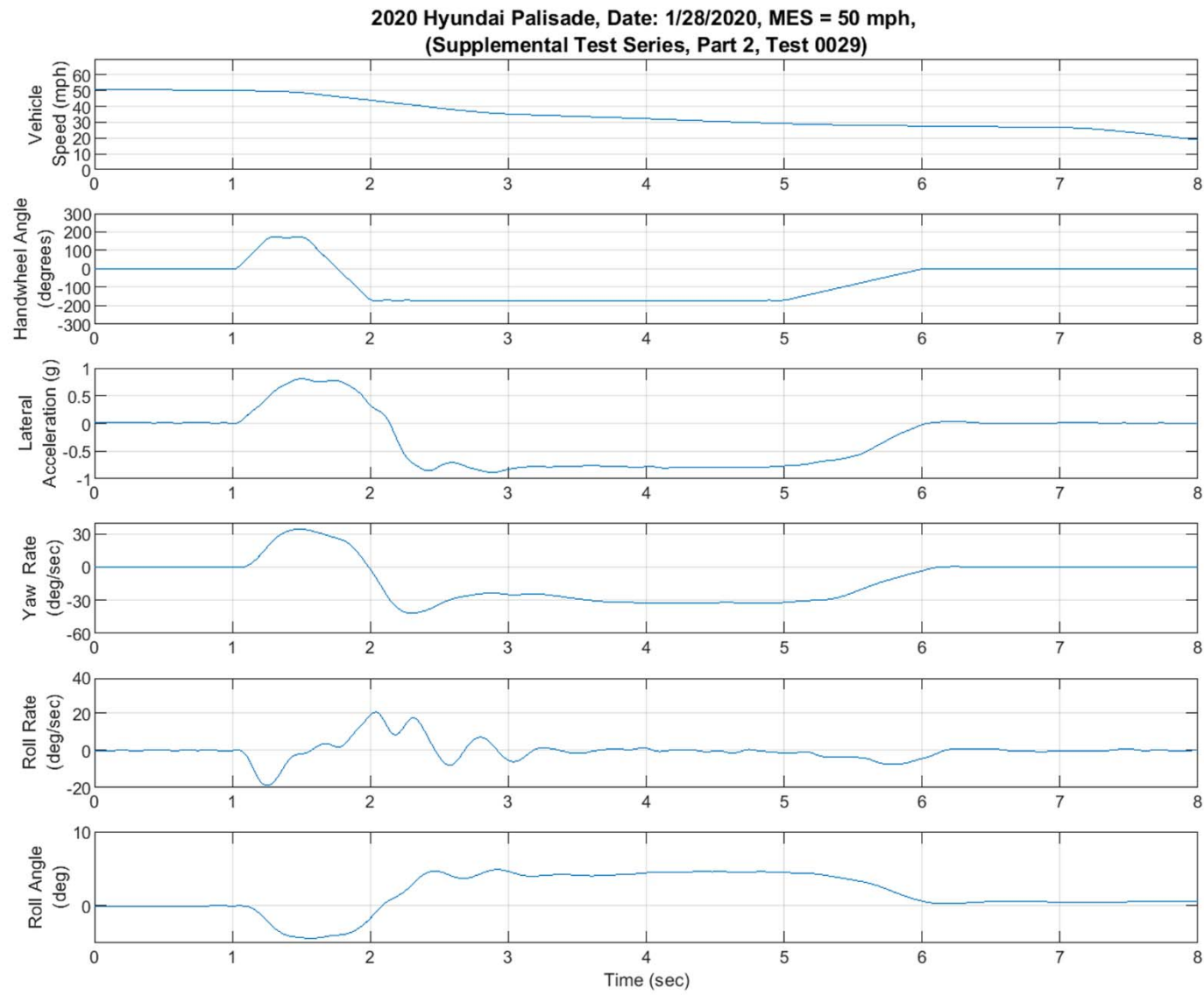

Figure D15. Yaw Rate, Roll Rate, and Lateral Acceleration Time History Plots for Supplemental 2 Test Series, R-L, 50 mph

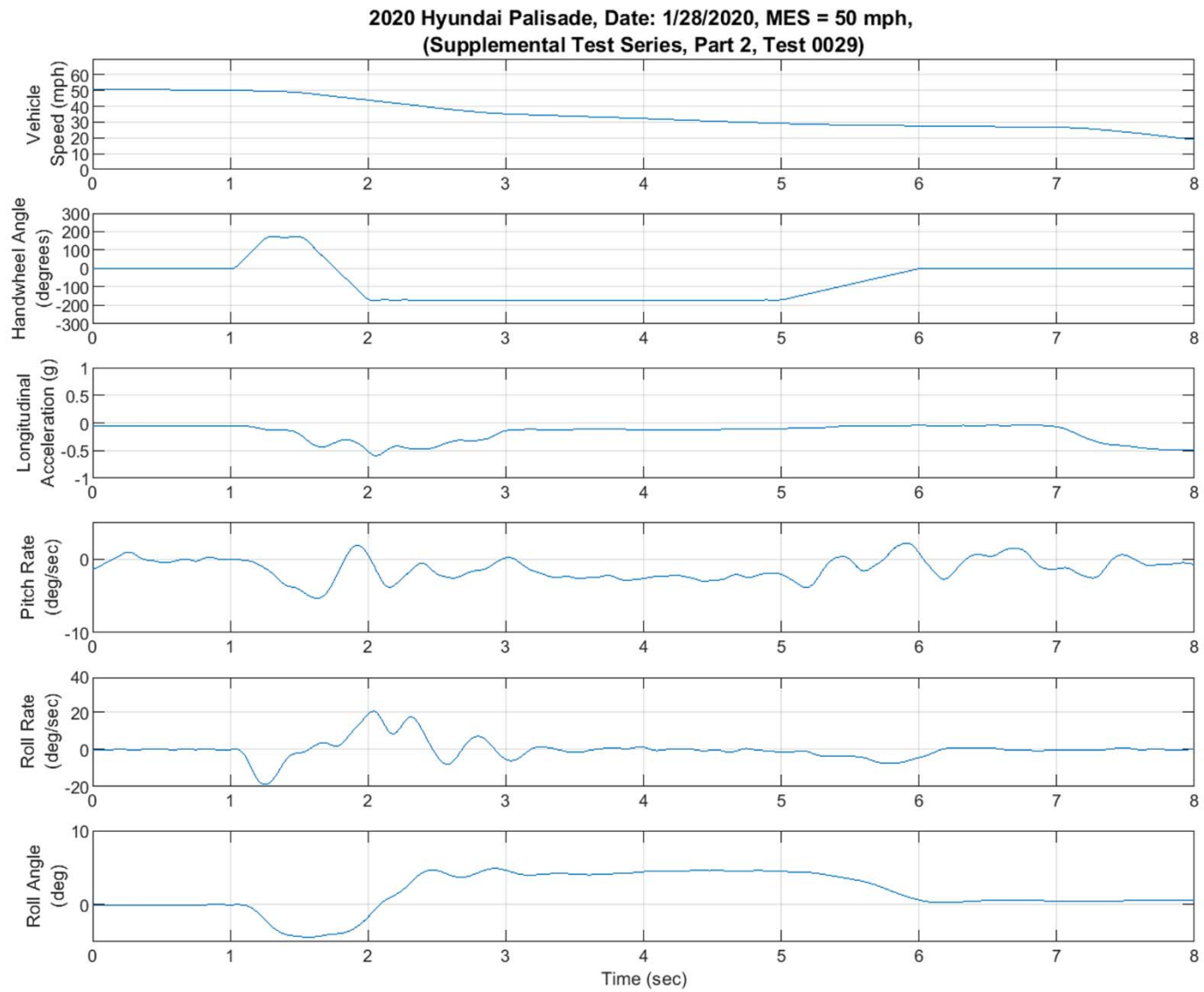

Figure D16. Pitch Rate and Longitudinal Acceleration Time History Plots for Supplemental 2 Test Series, R-L, 50 mph