

**NEW CAR ASSESSMENT PROGRAM (NCAP)  
DYNAMIC ROLLOVER RESISTANCE TEST**

Ford Motor Company  
2015 Ford Transit RWD

TEST NUMBER: 15-08

Final Report  
6 November 2014



Prepared by:

Dynamic Research, Inc  
355 Van Ness Ave. #200  
Torrance, CA 90501

Prepared for:

National Highway Traffic Safety Administration  
Office of Crash Avoidance Standards  
1200 New Jersey Avenue S.E.  
Washington, DC 20590

The United States Government assumes no liability for the contents of this report or use thereof. If trade or manufacturers' names or products are mentioned, it is only because they are considered essential to the object of the publication and should not be construed as an endorsement. The United States Government does not endorse products or manufacturers.

Dynamic Research, Inc. does not endorse or certify products of manufacturers. The manufacturer's name appears solely to identify the test article. Dynamic Research, Inc. assumes no liability for the report or use thereof. It is responsible for the facts and the accuracy of the data presented herein. This report does not constitute a standard, specification, or regulation.

Report Prepared by:

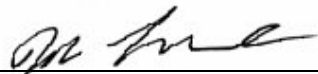

John Lenkeit, Program Manager

Date: 6 November 2014

Report Approved by:

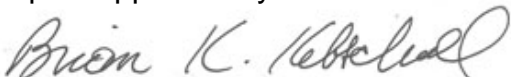

Brian Kebschull, Principal Engineer

Date: 6 November 2014

1. Report No. <b>15-08</b>	2. Government Accession No.	3. Recipient's Catalog No.	
4. Title and Subtitle <b>NCAP Dynamic Rollover Resistance Maneuver (Fishhook) Test of a 2015 Ford Transit RWD Van</b>		5. Report Date <b>6 November 2014</b>	6. Performing Organization Code <b>DRI</b>
		8. Performing Organization Report No. <b>DRI- TM-14-84</b>	
7. Author(s) <b>John Lenkeit, Program Manager Brian Keschull, Project Engineer</b>		10. Work Unit No. (TRAIS)	
9. Performing Organization Name and Address <b>Dynamic Research, Inc. 355 Van Ness Ave. #200 Torrance, CA 90501</b>		11. Contract or Grant No. <b>DTNH22-14-D-00332</b>	
		13. Type of Report and Period Covered <b>Final Report October – November 2014</b>	
12. Sponsoring Agency Name and Address  <b>National Highway Traffic Safety Administration Office of Crash Avoidance Standards 1200 New Jersey Avenue S.E. Washington, DC 20590</b>		14. Sponsoring Agency Code	
		15. Supplemental Notes	
16. Abstract  An NCAP Dynamic Rollover Maneuver (Fishhook) Test was conducted on a 2015 Ford Transit RWD at Dynamic Research, Inc. on October 22, 2014. The vehicle did not experience two-wheel lift. The vehicle's steering angle at 0.3 g lateral acceleration at 50 mph was 29.8 degrees.			
17. Key Words <b>NCAP Rollover Resistance Ratings Fishhook Test</b>		18. Distribution Statement Copies of this report are available from: National Highway Traffic Safety Admin. Office of Crash Avoidance Standards 1200 New Jersey Ave., S.E., Room W43-461 Washington, DC 20590	
19. Security Classif. (of this report) <b>Unclassified</b>	20. Security Classif. (of this page) <b>Unclassified</b>	21. Number of Pages <b>50</b>	22. Price

## TABLE OF CONTENTS

	Page
I. INTRODUCTION.....	1
II. VEHICLE PREPARATION .....	2
A. Test Vehicle .....	2
B. Tires .....	2
C. Vehicle Loading.....	2
D. Steering Controller .....	5
E. Instrumentation and Data Collection .....	5
F. Other Vehicle Preparation .....	5
III. TEST PROCEDURES.....	8
A. Test Procedure Overview.....	8
B. Test Conditions .....	9
IV. RESULTS.....	12
APPENDIX A Photographs .....	A-1
APPENDIX B Test Run Log.....	B-1
APPENDIX C Slowly Increasing Steer Test Worksheet.....	C-1
APPENDIX D Time History Plots .....	D-1

## LIST OF FIGURES

	Page
1. Nominal Position of Video Cameras for Fishhook Tests .....	8
2. DRI-Minter Vehicle Dynamics Area .....	12

## LIST OF TABLES

	Page
1. Test Vehicle Data .....	3
2. Tire Information .....	4
3. Vehicle Loading .....	4
4. Sensors .....	7
5. Surface Friction .....	10
6. Handwheel Angles .....	11
7. Weather Conditions .....	11

Section I  
INTRODUCTION

Beginning with the 2006 fiscal year, the National Highway Traffic Safety Administration (NHTSA) has engaged Dynamic Research, Inc. (DRI) of Torrance, CA to conduct dynamic rollover testing and gather data from that testing as part of NHTSA's New Car Assessment Program (NCAP).

The purpose of the testing reported herein was to determine if a typical 2015 Ford Transit RWD would experience tip-up, defined as simultaneous two-wheel lift of two inches or more at an entry speed of 50 mph or less in the Fishhook Procedure developed by NHTSA. This procedure may be found at [www.regulations.gov](http://www.regulations.gov), docket item NHTSA-2006-26555-0136.

The testing reported herein was accomplished under contract DTNH22-14-D-00332. The task order is entitled, "New Car Assessment Program (NCAP) Non-Destructive Vehicle Testing and Data Gathering."

## Section II VEHICLE PREPARATION

### A. TEST VEHICLE

The test vehicle was new or in as-new condition, meaning the vehicle had been driven no more than 500 miles prior to the start of dynamic rollover testing. It was acquired through a commercial rental/leasing company. Details of the test vehicle are given in Table 1.

### B. TIRES

All tires used were new, and of the same make, model, size, and DOT specification of those installed on the vehicle when purchased new. Tire inflation pressures were in accordance with the recommendations indicated on each vehicle's identification placard. To reduce the possibility of tire debanding during Fishhook testing, an appropriately sized inner tube was installed in each tire. To further reduce the possibility of tire debanding, the tires were mounted to the rims without the use of tire mounting lubricant. Tire specifications are listed in Table 2.

### C. VEHICLE LOADING

The multi-passenger load, described in the Fishhook Procedure, was used for all tests. The load and positioning of the load in the vehicle are listed in Table 3.

In addition to water dummies, the loading included instrumentation, a steering machine, and outriggers. Test vehicle bumper assemblies were removed for outrigger installation. The reduction in vehicle weight due to the removal of the bumpers was offset by the additional weight of the outriggers and their mounting system. The outrigger system typically outweighs the bumper assemblies.



Table 1. Test Vehicle Data

<b>General Data</b>					
Model year, make, model	2015 Ford Transit RWD				
VIN	1FMZK1YM6FKA1xxxx				
Body style	Van				
Number of doors	3				
Trim level	XLT				
Seating positions	Front:	2 <sup>nd</sup> row	3 <sup>rd</sup> row	4 <sup>th</sup> row	5 <sup>th</sup> row
	2	3	3		
Electronic stability control	Yes				
4-Wheel ABS (Yes/No)	Yes				
Power steering (Yes/No)	Yes				
Major optional equipment	Cloth 10-way power seats, Reverse Park Aid, AM/FM/SG-CD/HD/Sirius w/sync, Rear View Camera, 2 additional keys, Privacy Glass				
Odometer at start of testing	41 miles				
<b>Drivetrain</b>					
Engine cylinder arrangement	V-6				
Engine displacement	3.7 L				
Transmission type	Automatic				
Drive arrangement	RWD				
<b>Chassis</b>					
Track width	F: 68.2 in (1732.3 mm) , R: 68.6 in (1742.4 mm)				
Wheelbase	129.9 in (3299.5 mm)				
Curb weight	5612lb ( 1593 kg)				
<b>Certification Data from Vehicle's Label</b>					
Vehicle manufactured by	Ford Motor Company				
Date of manufacture	08/14				
GVWR	8550 lb (3878 kg)				
GAWR Front	4130 lb (1873 kg)				
GAWR Rear	5070 lb (2300 kg)				

Table 2. Tire Information

Tire Manufacturer	Continental
Tire Model	VancoFourSeason
Tire Size	Front: 235/65R16 Rear: 235/65R16
Load rating	Front: 121 Rear: 121
Speed rating	Front: R Rear: R
Treadwear grade	Front: Rear:
Traction grade	Front: Rear:
Temperature grade	Front: Rear:
Location of "Recommended Tire Pressure" label	Driver side door jamb
Recommended cold tire pressure	Front: 49 psi, (340 kPa) Rear: 71 psi, (490 kPa)
First 8 digits of DOT code	Front: 65B0 HN6C Rear: 65B0 HN6C

Table 3. Vehicle Loading

Water dummy and other loading	3 water dummies in second row
Water dummy weight	175 lb (79.4 kg)
Fuel level	Full
<b>Weight as Tested</b>	
Left front	1781 lb (807.8 kg)
Right front	1652 lb (749.3 kg)
Left rear	1565 lb (709.9 kg)
Right rear	1570 lb (712.1 kg)

## D. STEERING CONTROLLER

A programmable steering machine was installed which generates handwheel steering inputs for all test maneuvers. The machine provides at least 35 lb-ft of torque at a handwheel rate of 720 deg/sec, is capable of actuating the vehicle's steering system through its full range, and accepts angular rate sensor feedback input for roll rate-induced steering reversals.

## E. INSTRUMENTATION AND DATA COLLECTION

The test vehicle was instrumented with an angle encoder, located in the steering controller; a 3-axis inertial measurement unit to measure roll, pitch, and yaw rates, and longitudinal, lateral, and vertical acceleration; two ultrasonic distance measuring sensors to measure vehicle roll angle; and a radar speed sensor to measure vehicle speed. The brake light circuit was monitored to verify that there was no brake pedal application during any test.

A list of the sensors is given in Table 4. A 3B signal conditioning and power rack was used to provide any necessary sensor power, excitation, gain, and offset. Two pole Butterworth anti-alias filters were used for all analog data channels, using a corner frequency of 20 Hz. Data were collected at 200 samples/sec, using a Measurement Computing Corp. PCI-DAS6402/16 A/D board.

Two video cameras were used to record the Fishhook runs. They were positioned nominally as shown in Figure 1. The recorded videotapes were reviewed after the Fishhook runs to check for any two wheel lift. If any two wheel lift was observed, eight infrared distance measuring sensors for measurement of wheel lift (two sensors at each wheel) were then mounted for use in subsequent confirmation Fishhook tests.

## F. OTHER VEHICLE PREPARATION

In addition to installation and preparation discussed above, the test vehicle was prepared as follows:

- Front and rear bumpers were removed
- Outrigger mounts were installed in the bumper locations and titanium outriggers were fastened to these mounts
- A five point safety harness was installed.
- Airbags were removed or otherwise disabled

Photographs of the vehicle tested are given in Appendix A.

Table 4. Sensors

Data Measured	Type	Range	Manufacturer	Model Number
Handwheel angle	Encoder	Infinite	Automotive Testing, Inc.	Angle encoder integral with steering controller
Brake pedal actuation	Tape Switch	On/Off	Vericom Computers	VC3000
Longitudinal, lateral, and vertical acceleration	Multi-axis inertial sensing system	$\pm 2$ g	BEI Technologies, Inc., Systron Donner Inertial Division	MP-1
Roll, pitch, and yaw rate		$\pm 100$ deg/s		
Left and right side vehicle ride height (to measure roll angle)	Ultrasonic distance measuring system	4 - 40 inches	Massa Products Corp.	M-5000/220kHz
Vehicle speed	Radar speed sensor	0.1 - 125 mph	B+S Software und Messtechnik GmbH	DRS-6
Wheel lift (via resolution of two measured distances spaced a known distance apart), used for confirmation tests only	Analog displacement measuring system (Infrared; 880 mm)	13.8 - 33.5 in	Wenglor Sensors, Ltd.	HT 66MGV80

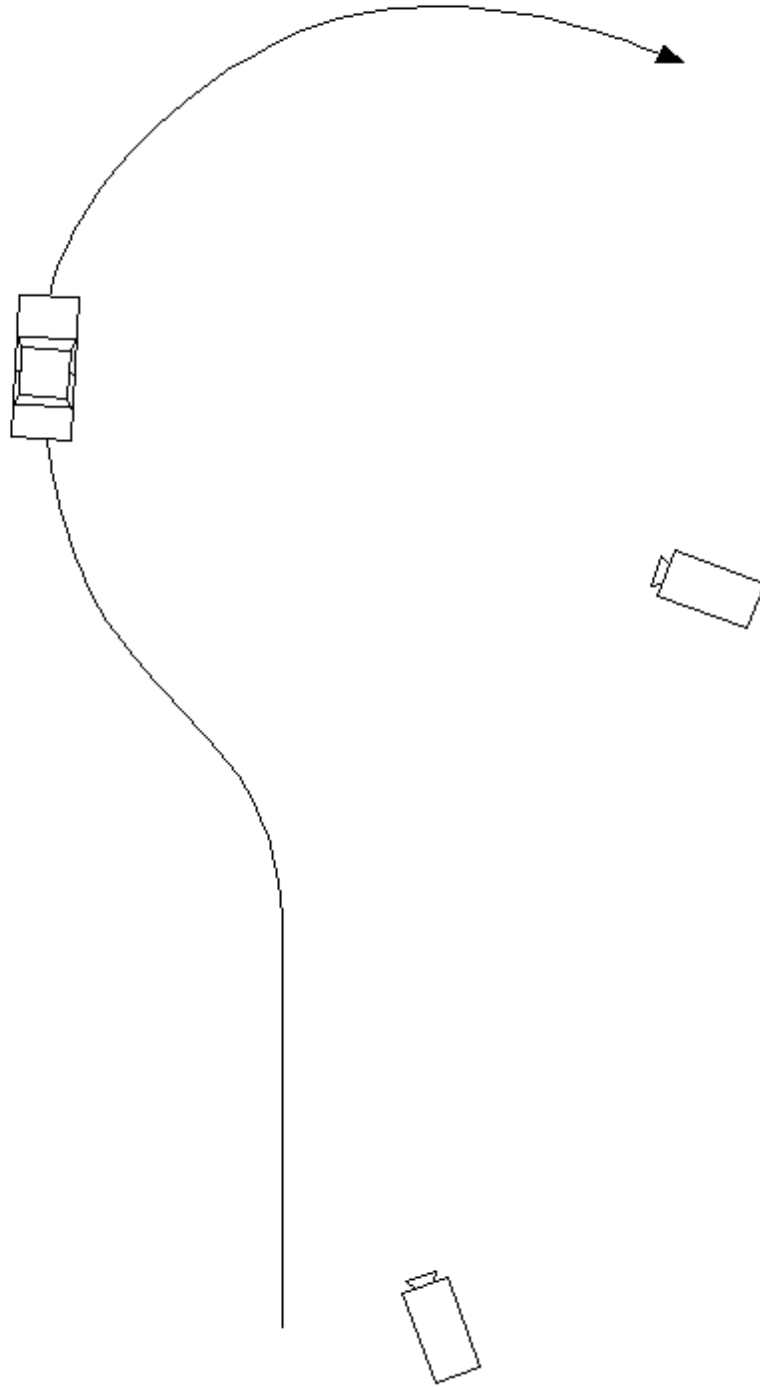

Figure 1. Nominal Position of Video Cameras for Fishhook Tests

### Section III TEST PROCEDURES

This section includes a general overview of the test procedures and details of the particular test.

#### A. TEST PROCEDURE OVERVIEW

This test was conducted in accordance with NHTSA's NCAP Rollover Resistance Test Procedure (Fishhook) as described in the Federal Register (68 FR 59250). Detailed descriptions of the test procedure, pass/fail criteria, and data acquisition specifications may be found at docket NHTSA-2001-9663.

There are two major components of the test procedure, the Slowly Increasing Steer (SIS) pre-test and the Fishhook test.

The Slowly Increasing Steer (SIS) maneuver was used to characterize the steady state lateral dynamics of each vehicle, and is based on the "Constant Speed, Variable Steer" test defined in SAE J266. The maneuver is used to determine the handwheel angle that produces a lateral acceleration of 0.3 g at 50 mph. This handwheel angle is then used to determine the magnitude of steering to be used for the NHTSA Fishhook maneuver.

SIS tests were performed at a constant speed of 50 mph. Handwheel angle was input at a rate of 13.5 deg/sec, from 0 to an angle that provided at least 0.55 g. Three tests were conducted in each direction, and the data for the six runs were averaged to obtain the handwheel angle that produced 0.3 g at 50 mph.

The Fishhook test is a programmed steering maneuver that is implemented via the steering controller. The vehicle was initially steered in one direction and then the steering was reversed. The timing, magnitude and rate of the steering were prescribed by the Fishhook Procedure.

To begin the maneuver, the vehicle was driven in a straight line at a speed slightly greater than the desired entrance speed. The driver then released the throttle. When the vehicle was at the target speed, the steering controller automatically initiated the steering maneuver. Following completion of the steering reversal the handwheel position was maintained for three seconds, and then returned to zero angle in 1 second.

The tests were conducted in both left-right and right-left directions. The “Default” test series used a handwheel angle equal to 6.5 times the handwheel angle that produced 0.3 g at 50 mph in the SIS tests, and initial vehicle speeds beginning at 35 mph and concluding up to 50 mph (if no two-wheel lift occurs). Supplemental tests were also done, as specified in the Fishhook Procedure.

## B. TEST CONDITIONS

### 1. Test Surface

The tests were conducted on the Vehicle Dynamics Area at DRI’s Minter Field facility, located near Bakersfield, California, on 10/22/2014. The VDA has a smooth, flat (slope less than 0.5% throughout) asphaltic concrete surface. Its dimensions are as shown in Figure 2. It was built in the spring of 2005.

VDA surface friction measurements were accomplished using the DRI Mobile Tire Tester. Three runs were done, one at each of three previously determined locations. Each run provided for a minimum of 3 seconds of tire friction at constant normal load, slip angle, and speed in a free rolling condition. The test was accomplished using an ASTM E1136 tire with an inflation pressure of 35 ( $\pm 0.5$ ) psi at a test speed of 40 ( $\pm 0.5$ ) mph. The net slip angle of the test tire for each test run was 7.5 deg. The test tire was no older than 6 months from the date of manufacture. The surface friction measurement results are shown in Table 5.

Table 5. Surface Friction

Date of surface friction measurements	10/22/2014
Average normalized lateral force	0.912

### 2. Fishhook Handwheel Angles

The 0.3g handwheel angle obtained from the SIS tests and the handwheel angles used in the Fishhook tests are shown in Table 6.

Table 6. Handwheel Angles

0.3g handwheel angle (from SIS tests at 50 mph)	29.8 °
5.5 scalar handwheel angle for Fishhook Test	164 °
6.5 scalar handwheel angle for Fishhook Test	194 °

### 3. Weather Conditions

The weather conditions, recorded at the end of testing, are shown in Table 7.

Table 7. Weather Conditions

Ambient temperature	75 °F ( 23.9 °C)
Wind Speed	3 mph (1.3 m/s)
Wind Direction	SW



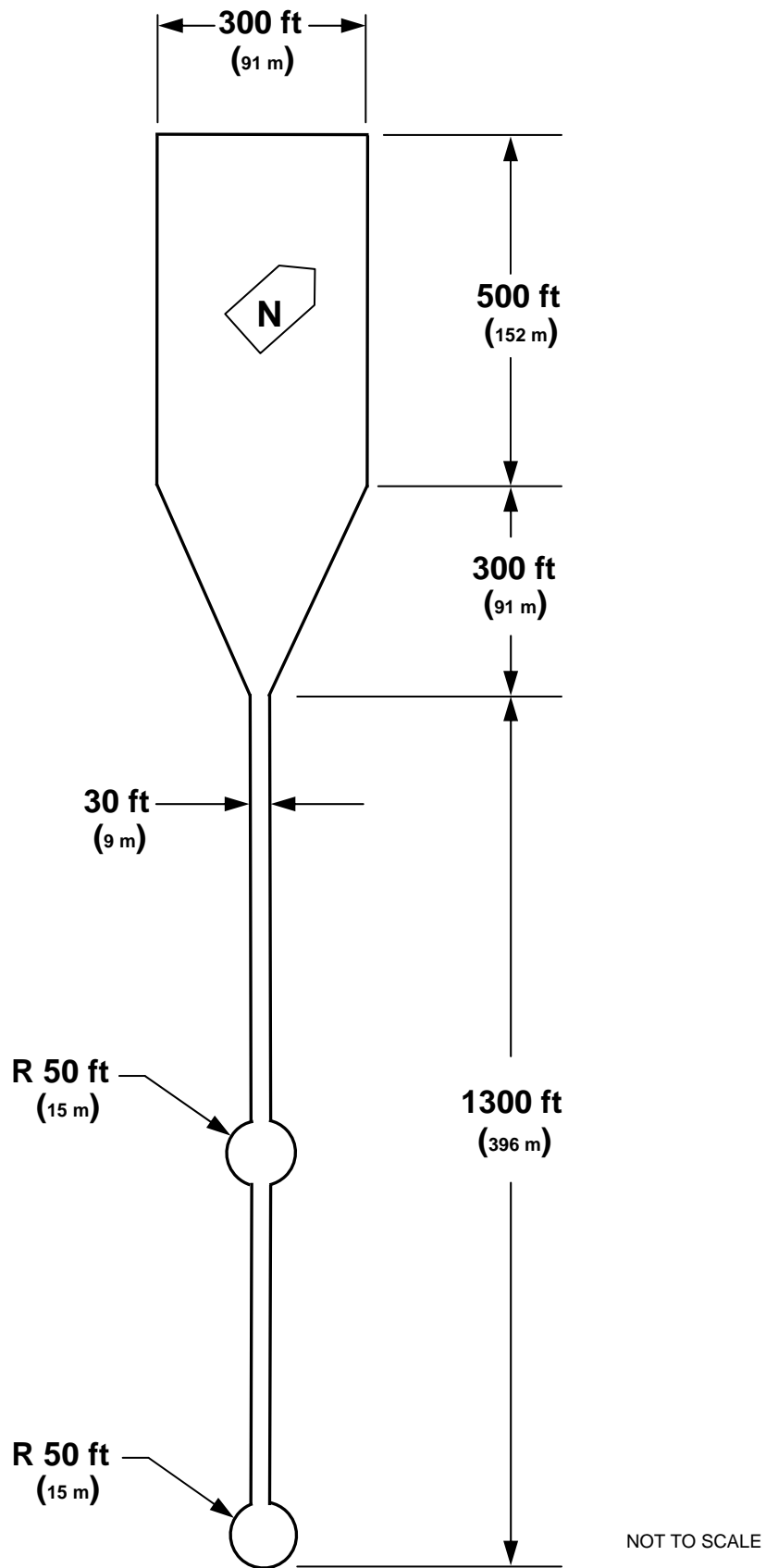

Figure 2. DRI-Minter Vehicle Dynamics Area

## Section IV RESULTS

The test run log is given in Appendix B. The Slowly Increasing Steer Test Worksheet is given in Appendix C. Appendix D contains time history plots for the 50 mph runs and any runs which resulted in two-wheel lift. For the 2015 Ford Transit RWD, there was no two-wheel lift at any test condition.

APPENDIX A

Photographs

LIST OF FIGURES

	Page
A1. Window Sticker.....	A-3
A2. Front View, Test Vehicle as Delivered .....	A-4
A3. Rear View, Test Vehicle as Delivered .....	A-5
A4. Front View, Test Vehicle in Test Condition.....	A-6
A5. Rear View, Test Vehicle in Test Condition .....	A-7
A6. Instrumentation in Test Vehicle .....	A-8
A7. Ballast Condition.....	A-9



Figure A1. Window Sticker



**Go Further**  
ford.com

VEHICLE DESCRIPTION

# TRANSIT

2015 TRANSIT 150 LR WAGON  
XL3 TRIM  
3.7L TiVCT V6 ENGINE  
6-SPD AUTO SELECT SHIFT TR

FK **A15769**

EXTERIOR  
OXFORD WHITE  
INTERIOR  
CHARCOAL CLOTH

EPA  
DOT

**Fuel Economy and Environment**

E85  
Flexible-Fuel Vehicle  
Gasoline-Ethanol (E85)

**Fuel Economy**

**16** MPG  
combined city/hwy

14 19 6.2  
city highway gallons per 100 miles

Driving Range  
Gasoline: 402 miles  
Ethanol (E85): 301 miles

Vans range from 11 to 16 MPG. The best vehicle rates 119 MPG. Values are based on gasoline and do not reflect performance and ratings based on E85. Distributing fuel also create emissions. Learn more at [fuelconomy.gov](http://fuelconomy.gov).

You spend  
**\$5,500**  
more in fuel costs  
over 5 years  
compared to the  
average new vehicle.

**Annual fuel cost**  
**\$3,300**

**Fuel Economy & Greenhouse Gas Rating** (tailpipe only) | **Smog Rating** (tailpipe only)

1 3 10 2 10  
Best Best

This vehicle emits 559 grams CO<sub>2</sub> per mile. The best emits 0 grams per mile (tailpipe only). Producing and distributing fuel also create emissions. Learn more at [fuelconomy.gov](http://fuelconomy.gov).

**Actual results will vary for many reasons, including driving conditions and how you drive and maintain your vehicle. The average new vehicle gets 24 MPG and costs \$11,000 to fund over 5 years. Cost estimates are based on 15,000 miles per year at \$3.50 per gallon. This is a dual fueled automobile. MPG is miles per gasoline gallon equivalent. Vehicle emissions are a significant cause of climate change and smog.**

**fuelconomy.gov**  
Calculate personalized estimates and compare vehicles

**GOVERNMENT 5-STAR SAFETY RATINGS**

**Overall Vehicle Score** Not Rated  
Based on the combined ratings of frontal, side and rollover. Should ONLY be compared to other vehicles of similar size and weight.

<b>Frontal Crash</b> <small>Based on the risk of injury in a frontal impact. Should ONLY be compared to other vehicles of similar size and weight.</small>	Driver	Not Rated
	Passenger	Not Rated
<b>Side Crash</b> <small>Based on the risk of injury in a side impact.</small>	Front seat	Not Rated
	Rear seat	Not Rated
<b>Rollover</b> <small>Based on the risk of rollover in a single-vehicle crash.</small>		Not Rated

**Star ratings range from 1 to 5 stars (\*\*\*\*\*), with 5 being the highest.**  
Source: National Highway Traffic Safety Administration (NHTSA).  
[www.safercar.gov](http://www.safercar.gov) or 1-888-327-4236

1FMZK1YM6FKAT

**INCLUDED ON THIS VEHICLE** (MSRP)

**OPTIONAL EQUIPMENT**

PREFERRED EQUIPMENT PKG.302A	NO CHARGE
3.73 RATIO REGULAR AXLE X73	NO CHARGE
HEADLINER COMPLETE	NO CHARGE
FRONT LICENSE PLATE BRACKET	NO CHARGE
8550# GWR PACKAGE	NO CHARGE
CHARCOAL CLOTH 10 WAY POWER	425.00
50 STATE EMISSIONS	NO CHARGE
REVERSE PARK AID	295.00
REAR WINDOW DEFOGGER	NO CHARGE
AM/FM/SGL-CD/HD/SIRIUS W/SYNC	540.00
REAR VIEW CAMERA	250.00
FRONT FLOOR MATS	
KEYS 2 ADDITIONAL	75.00
PRIVACY GLASS	675.00
FLEX FUEL	

**PRICE INFORMATION**

BASE PRICE	\$33,750.00
TOTAL OPTIONS	2,260.00
<b>TOTAL VEHICLE &amp; OPTIONS DESTINATION &amp; DELIVERY</b>	<b>36,010.00</b>
	995.00

**STANDARD EQUIPMENT INCLUDED AT NO EXTRA CHARGE**

<b>EXTERIOR</b>	<b>INTERIOR</b>	<b>FUNCTIONAL</b>	<b>SAFETY/SECURITY</b>
* SPARE TIRE AND WHEEL	* CLOTH HEADLINER	* POWER STEERING	* DRIVER/PASSENGER AIR BAGS
* RAIN SENSING WIPERS	* CENTER CONSOLE	* AIR CONDITIONING	* 3 POINT SAFETY BELTS
* BUMPERS - BLACK	* FLOOR COVERING - CARPETED	* AM/FM SINGLE CD W/AUX JACK	* 4-WHEEL DISC BRAKES W/ABS
* SINGLE SLIDING SIDE DOOR		* 26.0 GALLON FUEL TANK	* ADVANCETRAC W/RSC
* DUAL POWER MIRRORS		* POWER LOCKS AND WINDOWS	* TIRE PRESSURE MONITOR SYS
		* ALTERNATOR 150 AMP	* AIRBAGS - SAFETY CANOPY
			* SIDE AIRBAGS

**WARRANTY**

- 3YR/36000 BUMPER TO BUMPER
- 5YR/60,000 POWERTRAIN
- 6YR/60,000 ROADSIDE ASSIST

SOLD TO	RAMP ONE	DEALER NO.	<b>TOTAL MSRP \$37,005.00</b>
	CH27		
SHIP TO (IF OTHER THAN SOLD TO)	RAMP TWO	FINAL ASSEMBLY PLANT	This label is affixed pursuant to the Federal Automobile Information Disclosure Act. Gasoline, License, and Title Fees, State and Local taxes are not included. Dealer installed options or accessories are not included unless listed above.
		KANSAS CITY	
SHIP THROUGH	METHOD OF TRANSP.	ITEM #	
	CONVOY	71-1617 O/T 2	

**Extended Service Plan**

Ford ESP is the only extended service plan honored at every Ford dealership in the U.S. and Canada. See your dealer for additional details or visit [www.FordOwner.com](http://www.FordOwner.com) for more information.

**FORD CREDIT**

Choose the vehicle you want. Whether you decide to lease or finance, you'll find the choices that are right for you. See your Ford Dealer for details or visit [www.FordCredit.com](http://www.FordCredit.com).

**Go Further**

Scan this code to experience this vehicle or text 1FFKA15769 to 48028 or visit [ford.com/windowssticker](http://ford.com/windowssticker)

Standard messaging & data plan rates may apply.



Figure A2. Front View, Test Vehicle as Delivered



Figure A3. Rear View, Test Vehicle as Delivered



Figure A4. Front View, Test Vehicle in Test Condition





Figure A5. Rear View, Test Vehicle in Test Condition



Figure A6. Instrumentation in Test Vehicle



Figure A7. Ballast Condition

APPENDIX B

Test Run Log

Vehicle: **2015 Ford Transit RWD**Driver: **Theresa Cornwell**Date: **10/22/2014**

Run Number	Test Type	Speed (mph)	Handwheel Angle (deg)	Dir. of First Steer	2 Wheel Lift	Notes
	Distance		0	NA	NA	Distance Calibration (ft):
1	Tire Warm-Up	35	120	NA	NA	
2	Tire Warm-Up	35	120	NA	NA	
3	Tire Warm-Up	35	120	NA	NA	
4	Tire Warm-Up	35	120	NA	NA	
5	Static	0	0	NA	NA	
6	Dynamic	50	0	NA	NA	
13	SIS	50	60	Left	NA	
14	SIS	50	60	Left	NA	
15	SIS	50	60	Left	NA	
16	SIS	50	60	Right	NA	
17	SIS	50	60	Right	NA	
18	SIS	50	60	Right	NA	
19	Fishhook	35	194	Left	No	6.5x scalar
20	Fishhook	40	194	Left	No	
21	Fishhook	45	194	Left	No	
22	Fishhook	47.5	194	Left	No	
23	Fishhook	50	194	Left	No	
24	Fishhook	35	194	Right	No	
25	Fishhook	40	194	Right	No	
26	Fishhook	45	194	Right	No	
27	Fishhook	47.5	194	Right	No	
28	Fishhook	50	194	Right	No	
29	Fishhook	45	164	Right	No	5.5x scalar

Vehicle: **2015 Ford Transit RWD**Driver: **Theresa Cornwell**Date: **10/22/2014**

Run Number	Test Type	Speed (mph)	Handwheel Angle (deg)	Dir. of First Steer	2 Wheel Lift	Notes
30	Fishhook	47.5	164	Right	No	
31	Fishhook	50	164	Right	No	
32	Fishhook	45	164	Left	No	
33	Fishhook	47.5	164	Left	No	
34	Fishhook	50	164	Left	No	

APPENDIX C

Slowly Increasing Steer Test Worksheet

NCAP, 2015 Ford Transit RWD , Multi-Passenger Load, Test Date: 10/22/2014

SIS\_out\_v2

Run	Dir of Steer	Start Speed (mph)	End Speed (mph)	Speed Red. (%)	Index of ay @ 0.3g	HW Angle (deg) at 0.3g	ay (g) @ 0.3g index	6.5x HW Angle (deg)	Ramp Time (sec) at 6.5x	5.5x HW Angle (deg)	Ramp Time (sec) at 5.5x	R2	Zero Begin Index	Zero End Index
13	1	49.8	2.5	95.0	1109	-30.3	-0.306	-197.2	-0.2739	-166.9	-0.2318	0.9897	400	600
14	1	49.6	1	98.0	1116	-29.9	-0.291	-194.4	-0.27	-164.5	-0.2285	0.9899	473	673
15	1	50.1	1	97.9	1126	-31.0	-0.296	-201.5	-0.2799	-170.5	-0.2368	0.9958	508	708
16	0	50.0	0.1	99.9	1113	28.4	0.298	184.7	0.2565	156.3	0.2170	0.9982	548	748
17	0	50.8	0.3	99.5	1094	29.6	0.308	192.6	0.2674	162.9	0.2263	0.9959	461	661
18	0	50.7	0.2	99.7	1125	29.7	0.315	193.3	0.2685	163.6	0.2272	0.9854	500	700

Mean: 29.8 0.302 194 0.269 164 0.228

## Steering Controller Input Values

## Scalar 6.5 values:

Initial HW angle: 194 deg  
Initial time: 0.269 s  
Reversal HW angle: -194 deg  
Reversal time: 0.539 s

## Scalar 5.5 values:

Initial HW angle: 164 deg  
Initial time: 0.228 s  
Reversal HW angle: -164 deg  
Reversal time: 0.456 s



APPENDIX D

Time History Plots

## LIST OF FIGURES

	Page
D1. Vehicle Speed, Handwheel Angle, and Roll Angle Time History Plots for Default Test Series, L-R, 50 mph .....	D-3
D2. Steering Machine Operation Time History Plots for Default Test Series, L-R, 50 mph.....	D-4
D3. Yaw Rate, Roll Rate, and Lateral Acceleration Time History Plots for Default Test Series, L-R, 50 mph .....	D-5
D4. Pitch Rate and Longitudinal Acceleration Time History Plots for Default Test Series, L-R, 50 mph .....	D-6
D5. Vehicle Speed, Handwheel Angle, and Roll Angle Time History Plots for Default Test Series, R-L, 50 mph .....	D-7
D6. Steering Machine Operation Time History Plots for Default Test Series, R-L, 50 mph .....	D-8
D7. Yaw Rate, Roll Rate, and Lateral Acceleration Time History Plots for Default Test Series, R-L, 50 mph .....	D-9
D8. Pitch Rate and Longitudinal Acceleration Time History Plots for Default Test Series, R-L, 50 mph .....	D-10
D9. Vehicle Speed, Handwheel Angle, and Roll Angle Time History Plots for Supplemental 2 Test Series, L-R, 50 mph.....	D-11
D10. Steering Machine Operation Time History Plots for Supplemental 2 Test Series, L-R, 50 mph .....	D-12
D11. Yaw Rate, Roll Rate, and Lateral Acceleration Time History Plots for Supplemental 2 Test Series, L-R, 50 mph .....	D-13
D12. Pitch Rate and Longitudinal Acceleration Time History Plots for Supplemental 2 Test Series, L-R, 50 mph .....	D-14
D13. Vehicle Speed, Handwheel Angle, and Roll Angle Time History Plots for Supplemental 2 Test Series, R-L, 50 mph.....	D-15
D14. Steering Machine Operation Time History Plots for Supplemental 2 Test Series, R-L, 50 mph .....	D-16
D15. Yaw Rate, Roll Rate, and Lateral Acceleration Time History Plots for Supplemental 2 Test Series, R-L, 50 mph .....	D-17
D16. Pitch Rate and Longitudinal Acceleration Time History Plots for Supplemental 2 Test Series, R-L, 50 mph .....	D-18

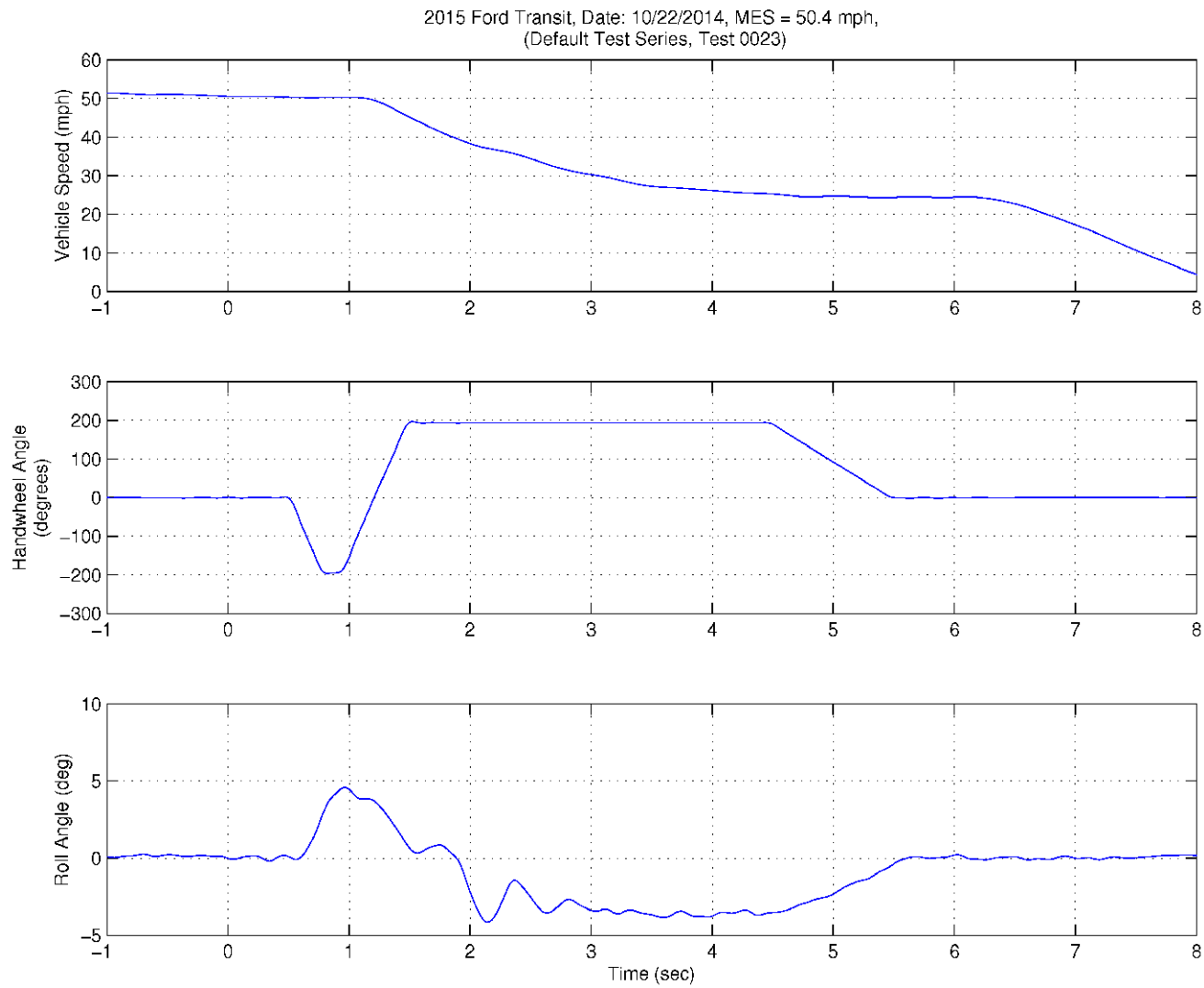

Figure D1. Vehicle Speed, Handwheel Angle, and Roll Angle Time History Plots for Default Test Series, L-R, 50 mph

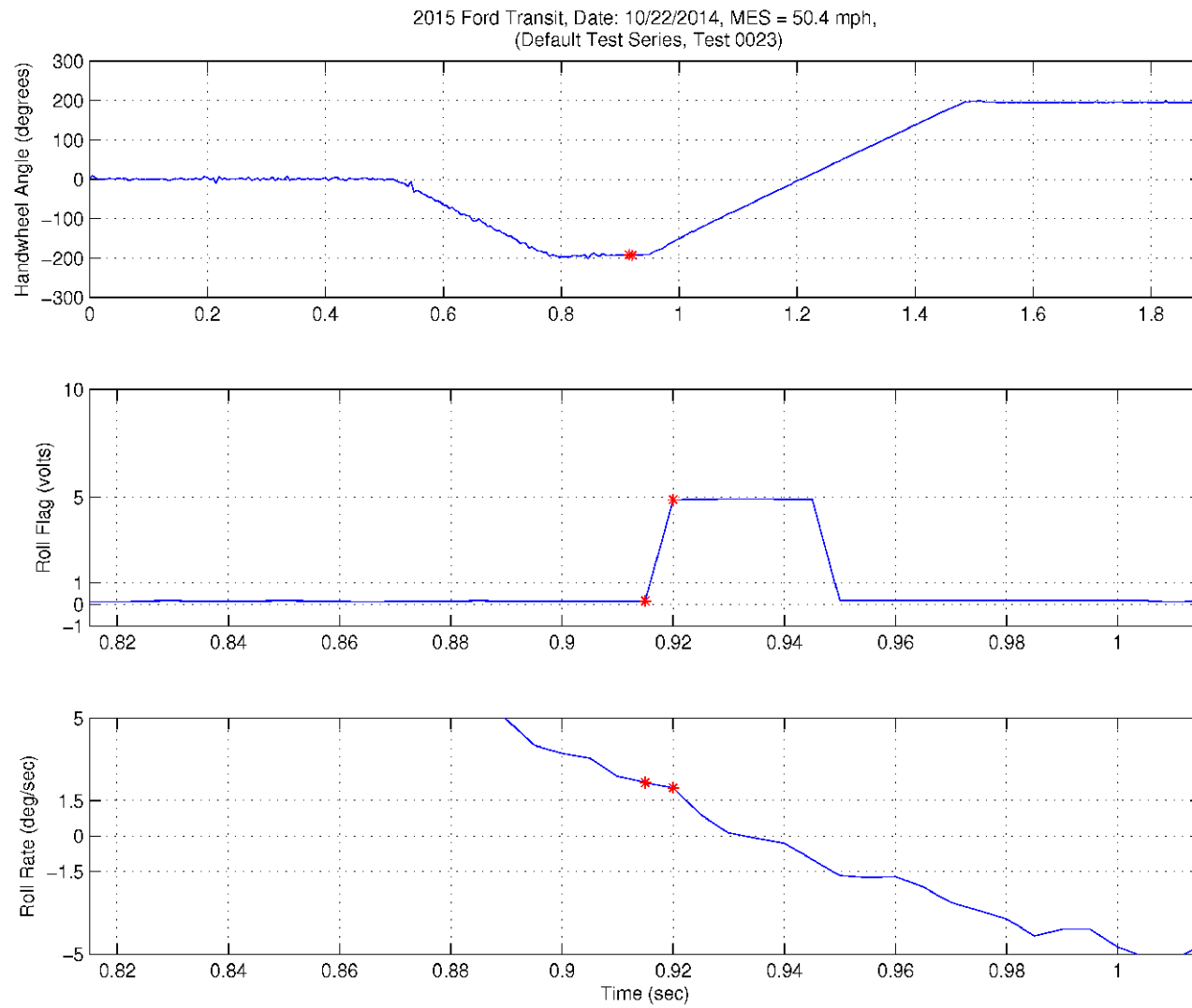

Figure D2. Steering Machine Operation Time History Plots for Default Test Series, L-R, 50 mph

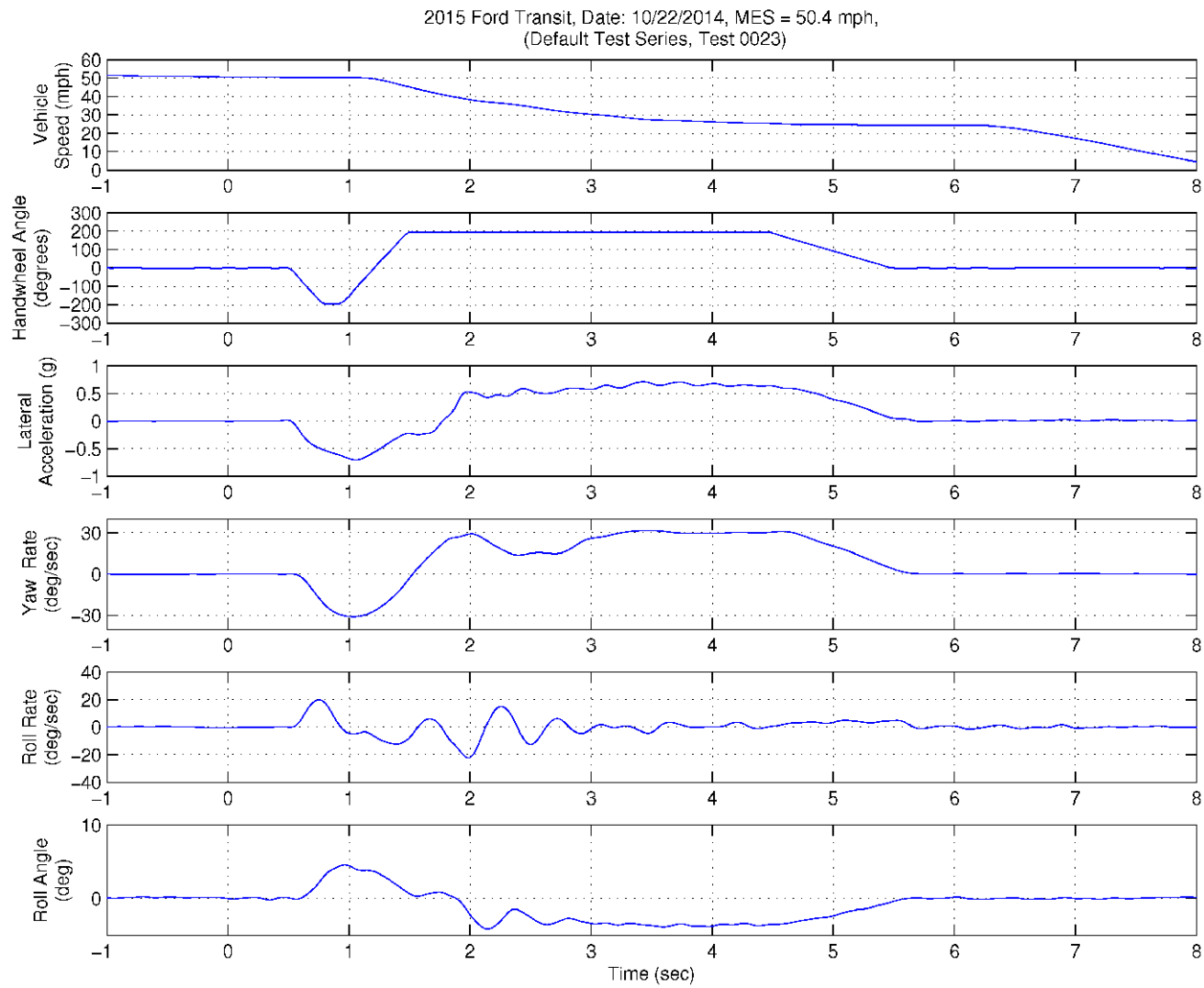

Figure D3. Yaw Rate, Roll Rate, and Lateral Acceleration Time History Plots For Default Test Series, L-R, 50 mph

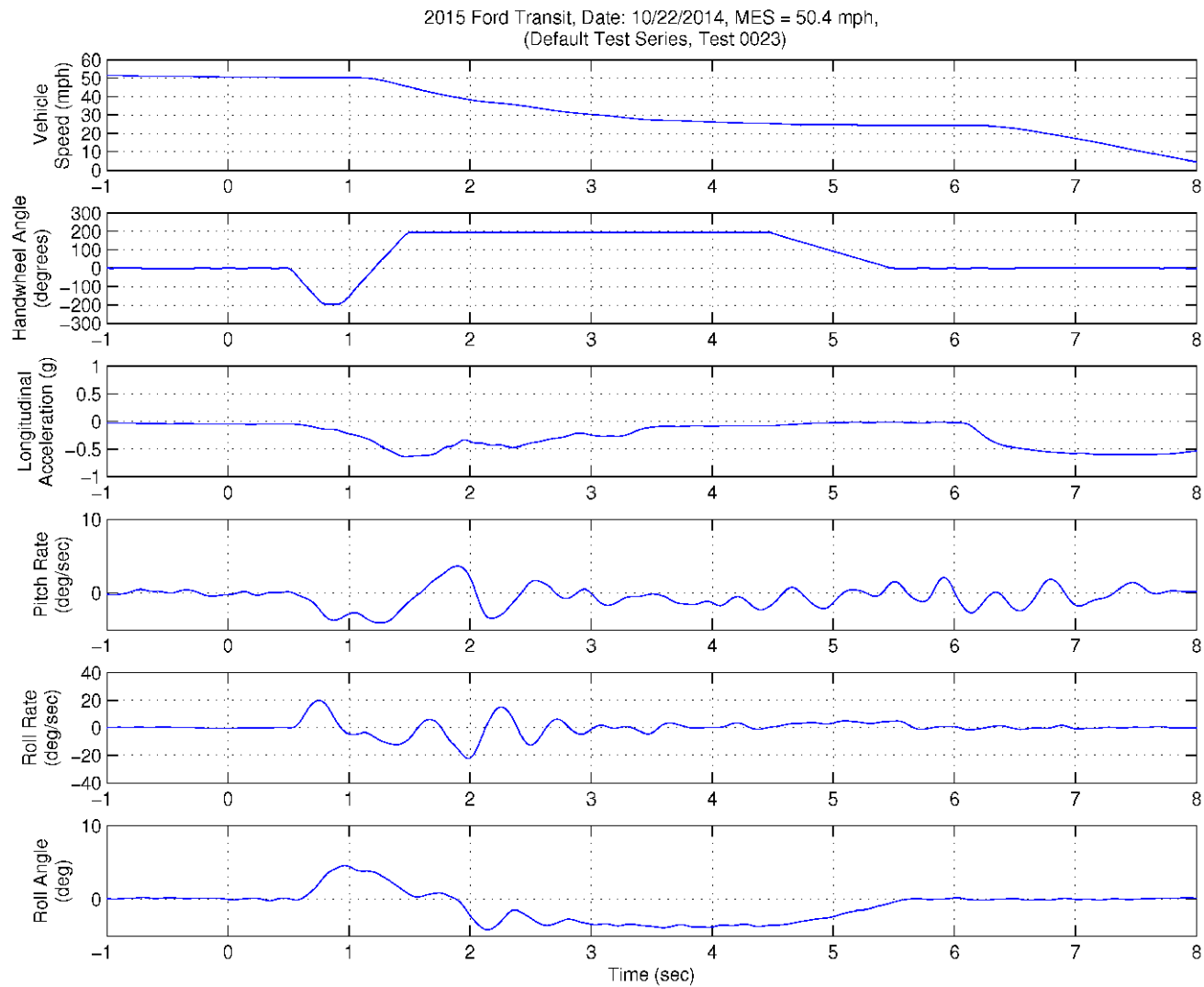

Figure D4. Pitch Rate and Longitudinal Acceleration Time History Plots for Default Test Series, L-R, 50 mph

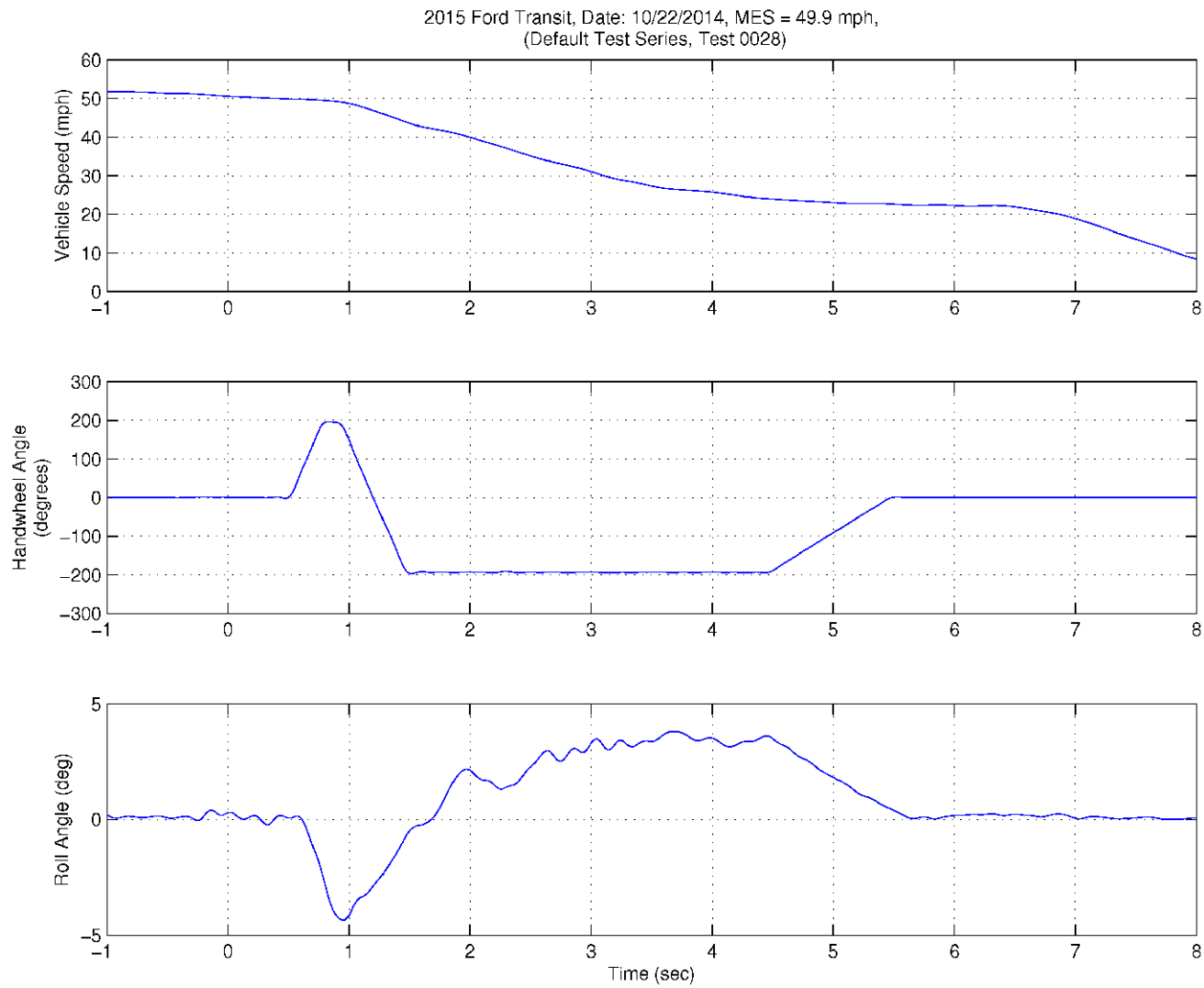

Figure D5. Vehicle Speed, Handwheel Angle, and Roll Angle Time History Plots for Default Test Series, R-L, 50 mph

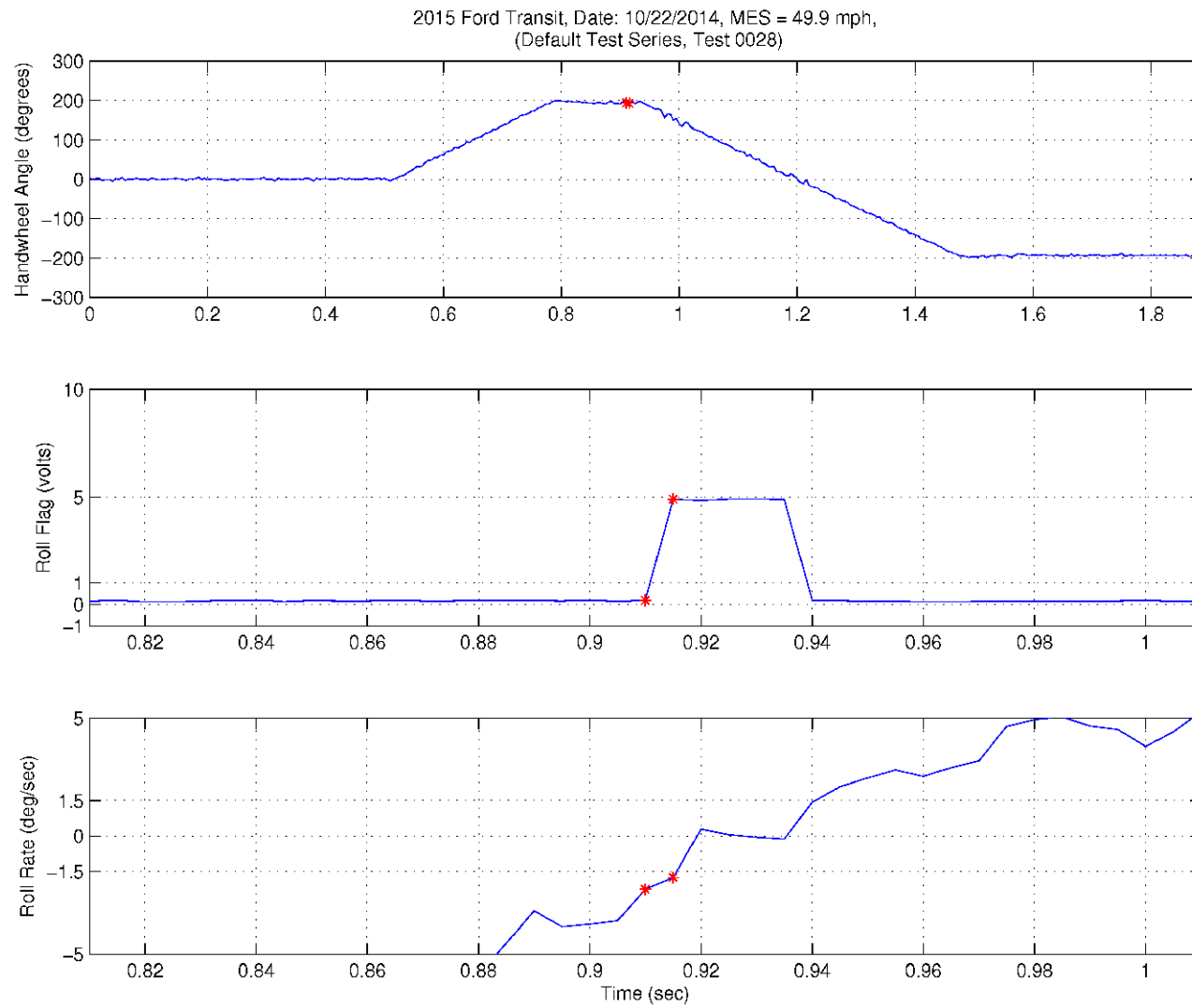

Figure D6. Steering Machine Operation Time History Plots for Default Test Series, R-L, 50 mph



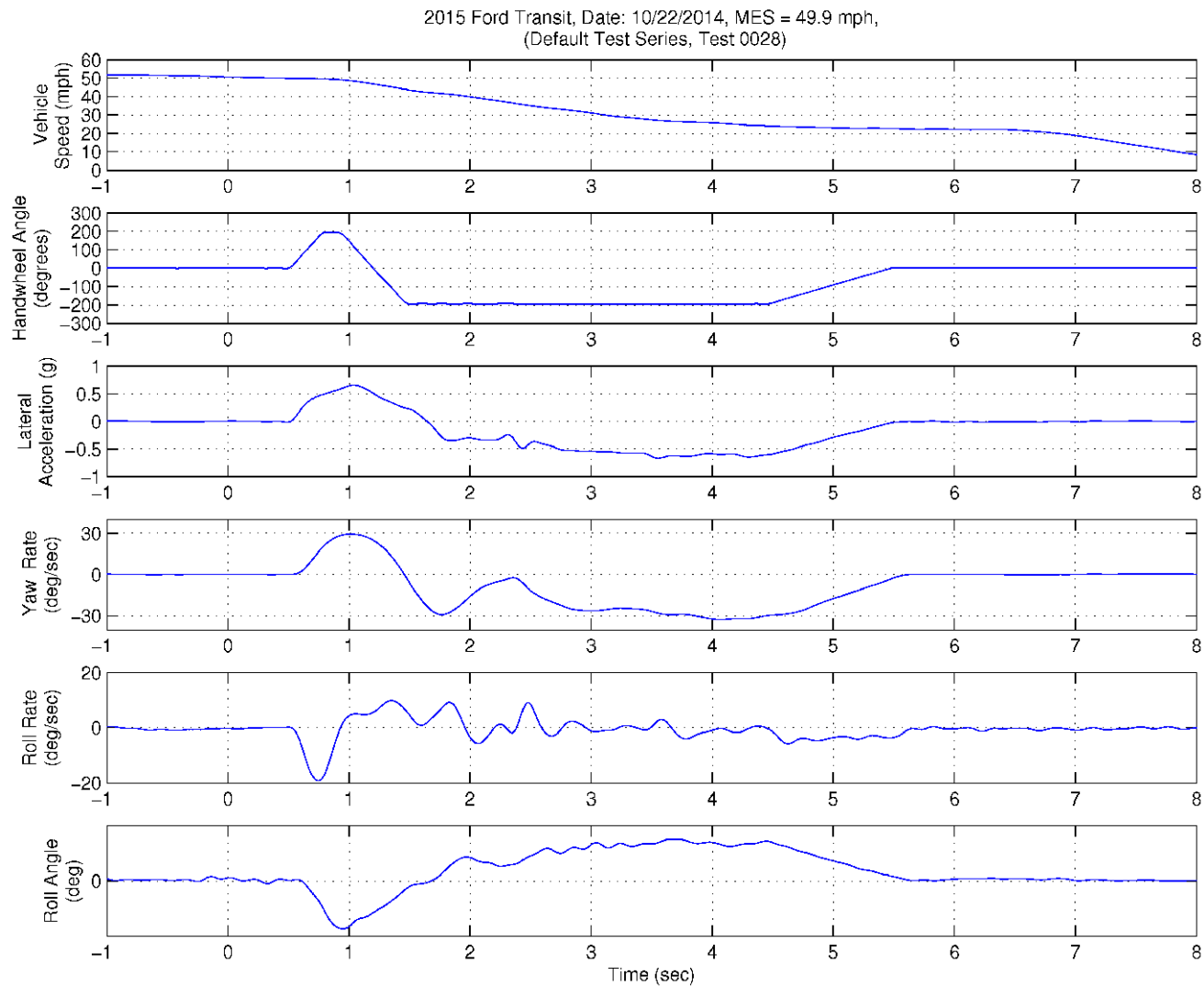

Figure D7. Yaw Rate, Roll Rate, and Lateral Acceleration Time History Plots for Default Test Series, R-L, 50 mph

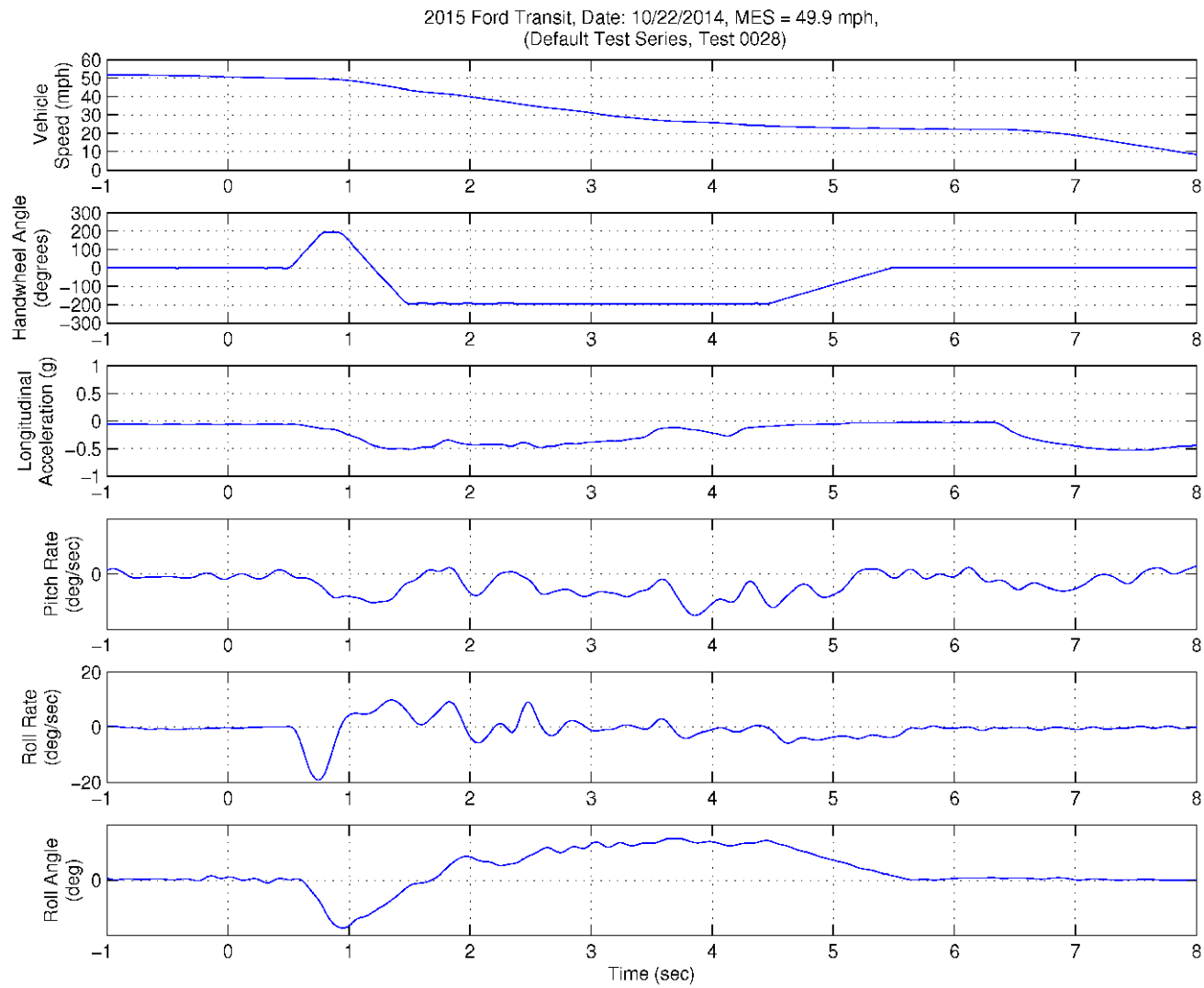

Figure D8. Pitch Rate and Longitudinal Acceleration Time History Plots or Default Test Series, R-L, 50 mph

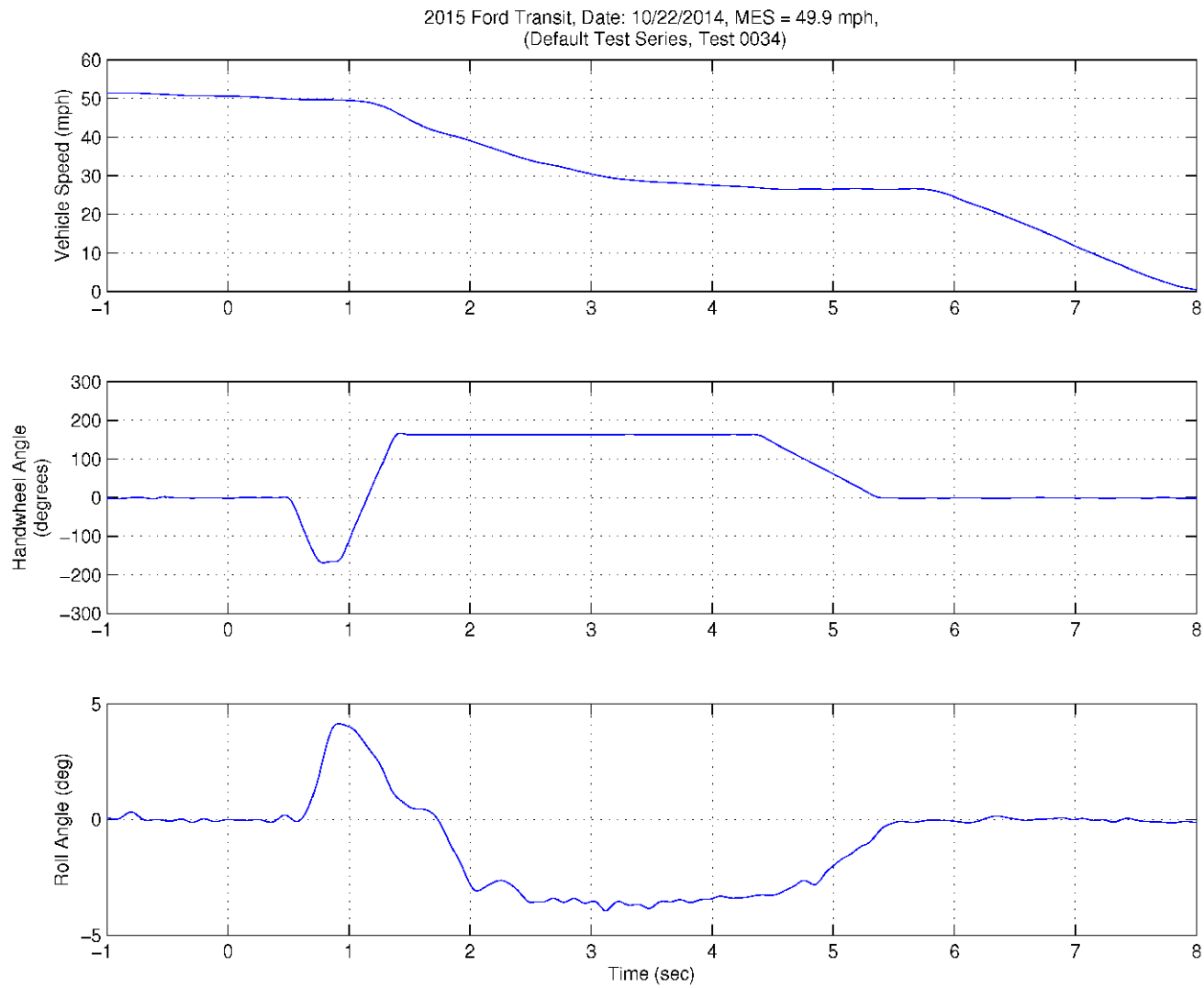

Figure D9. Vehicle Speed, Handwheel Angle, and Roll Angle Time History Plots for Supplemental 2 Test Series, L-R, 50 mph

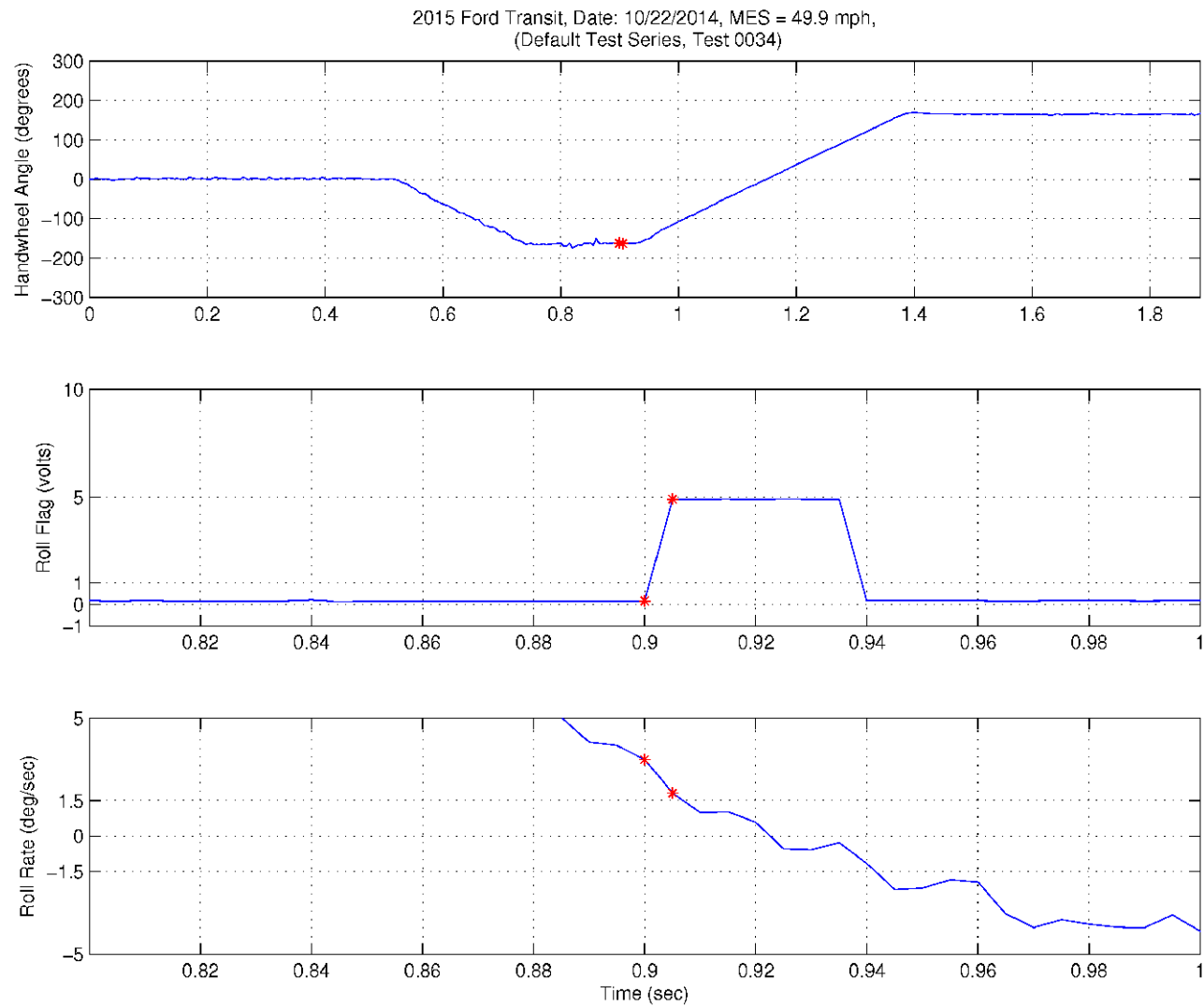

Figure D10. Steering Machine Operation Time History Plots for Supplemental 2 Test Series, L-R, 50 mph

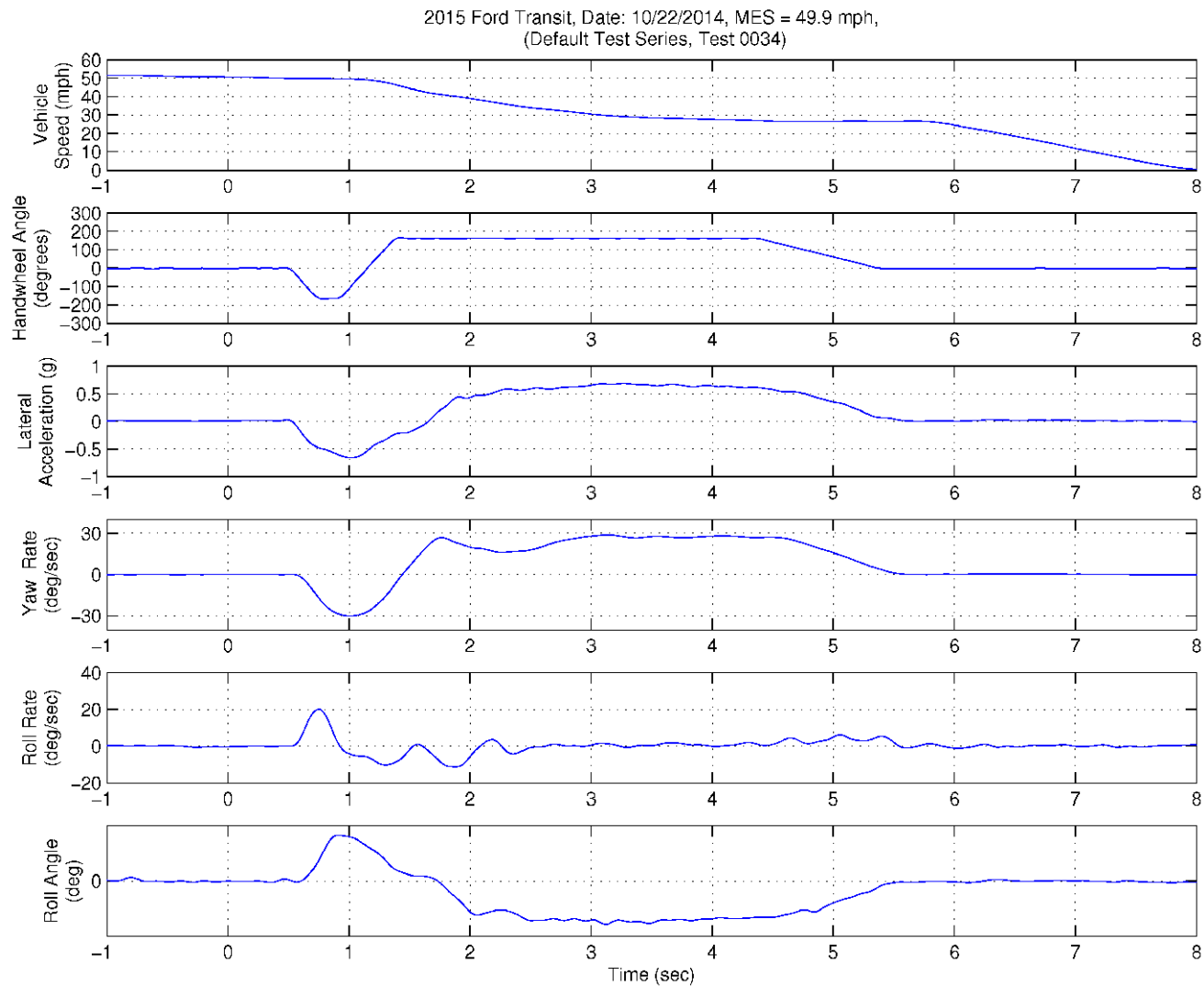

Figure D11. Yaw Rate, Roll Rate, and Lateral Acceleration Time History Plots for Supplemental 2 Test Series, L-R, 50 mph

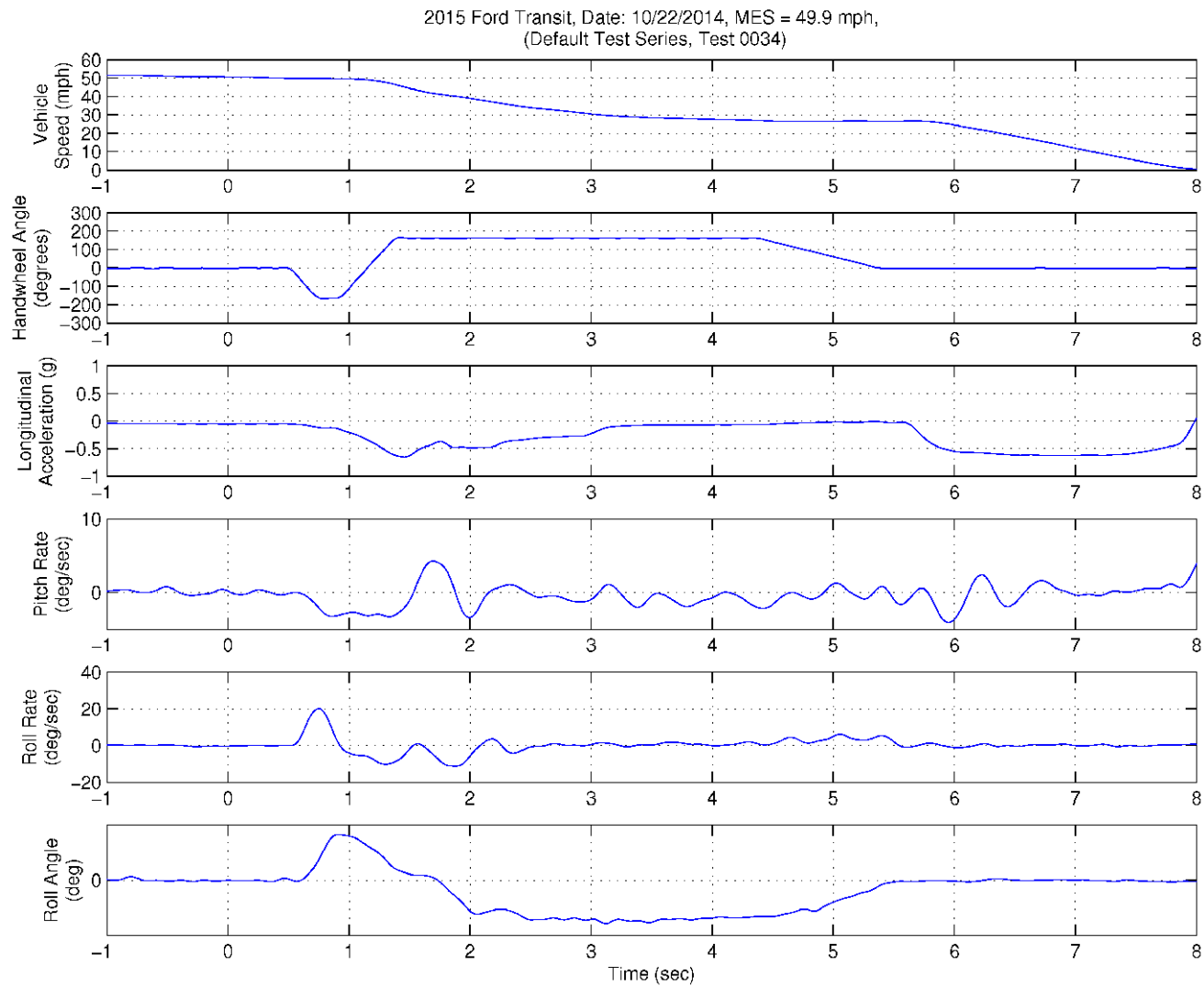

Figure D12. Pitch Rate and Longitudinal Acceleration Time History Plots for Supplemental 2 Test Series, L-R, 50 mph

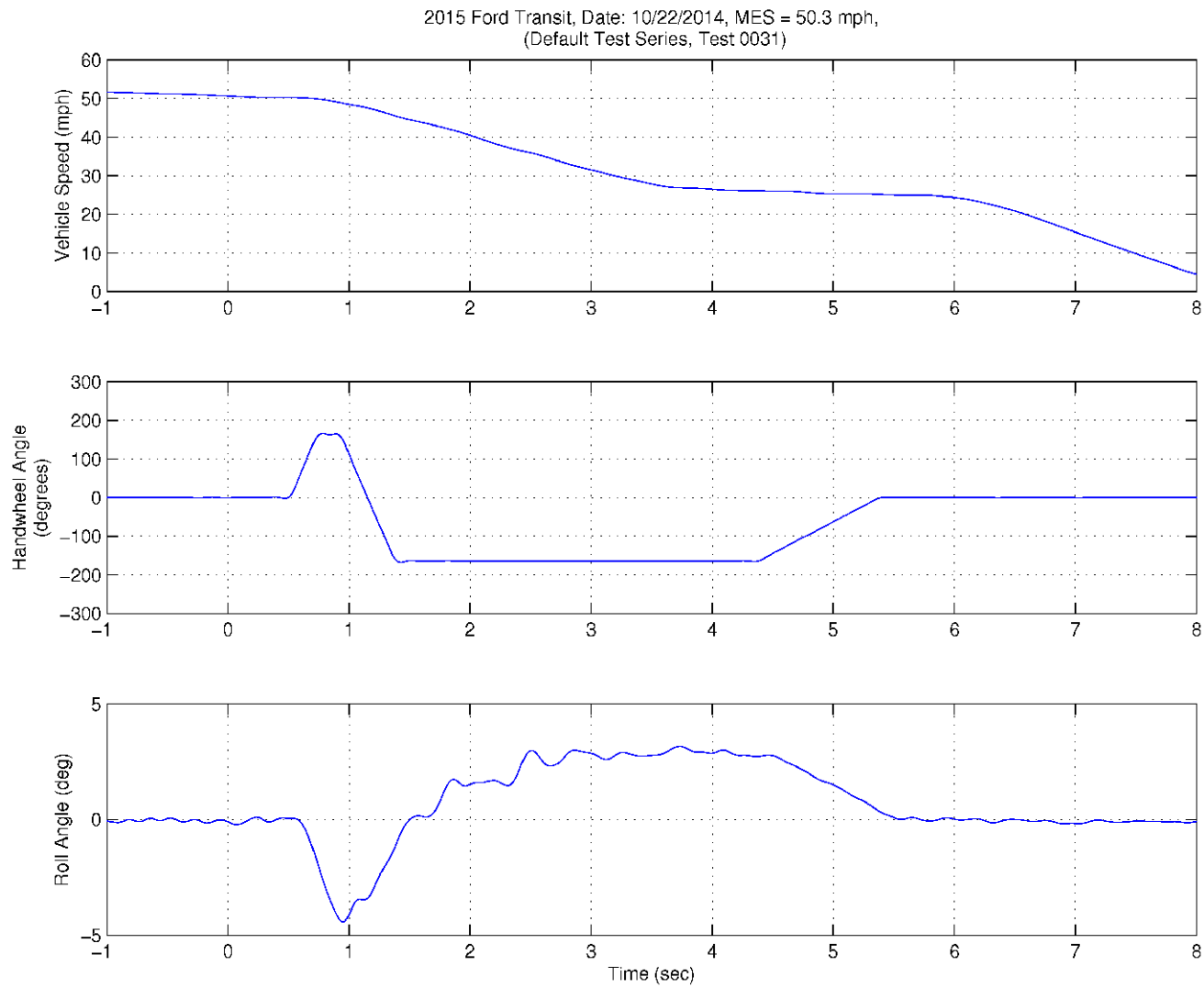

Figure D13. Vehicle Speed, Handwheel Angle, and Roll Angle Time History Plots for Supplemental 2 Test Series, R-L, 50 mph

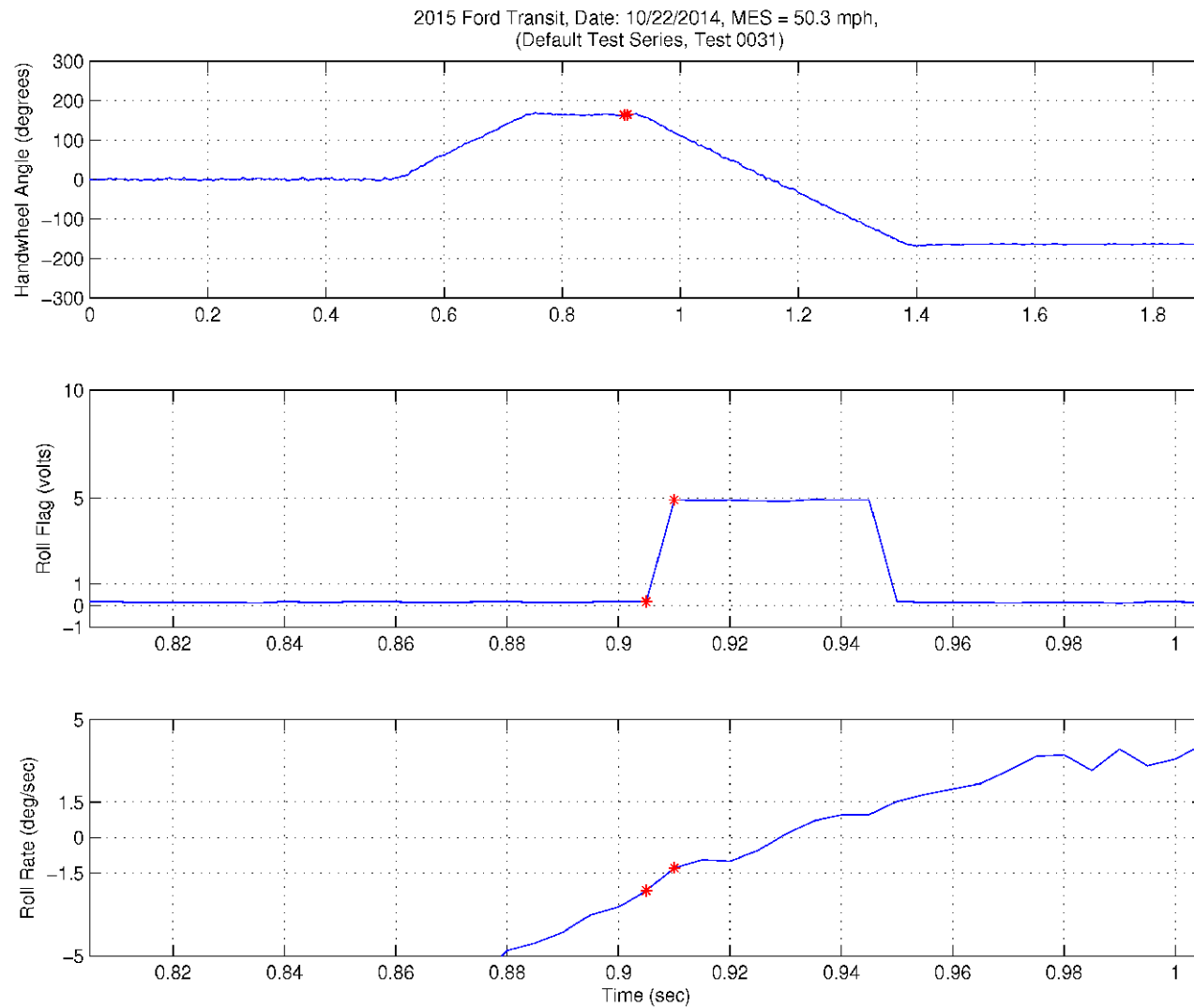

Figure D14. Steering Machine Operation Time History Plots for Supplemental 2 Test Series, R-L, 50 mph



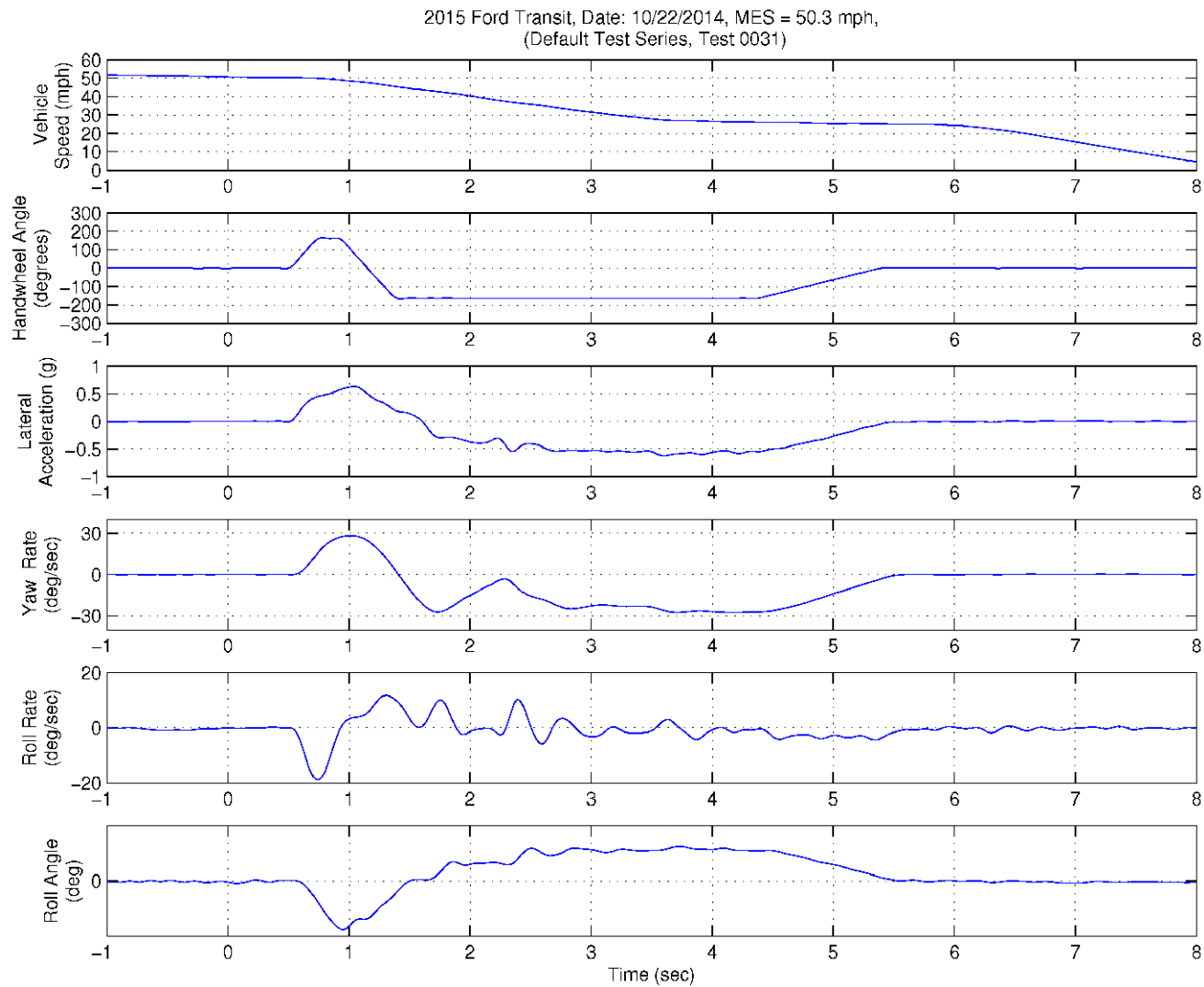

Figure D15. Yaw Rate, Roll Rate, and Lateral Acceleration Time History Plots for Supplemental 2 Test Series, R-L, 50 mph

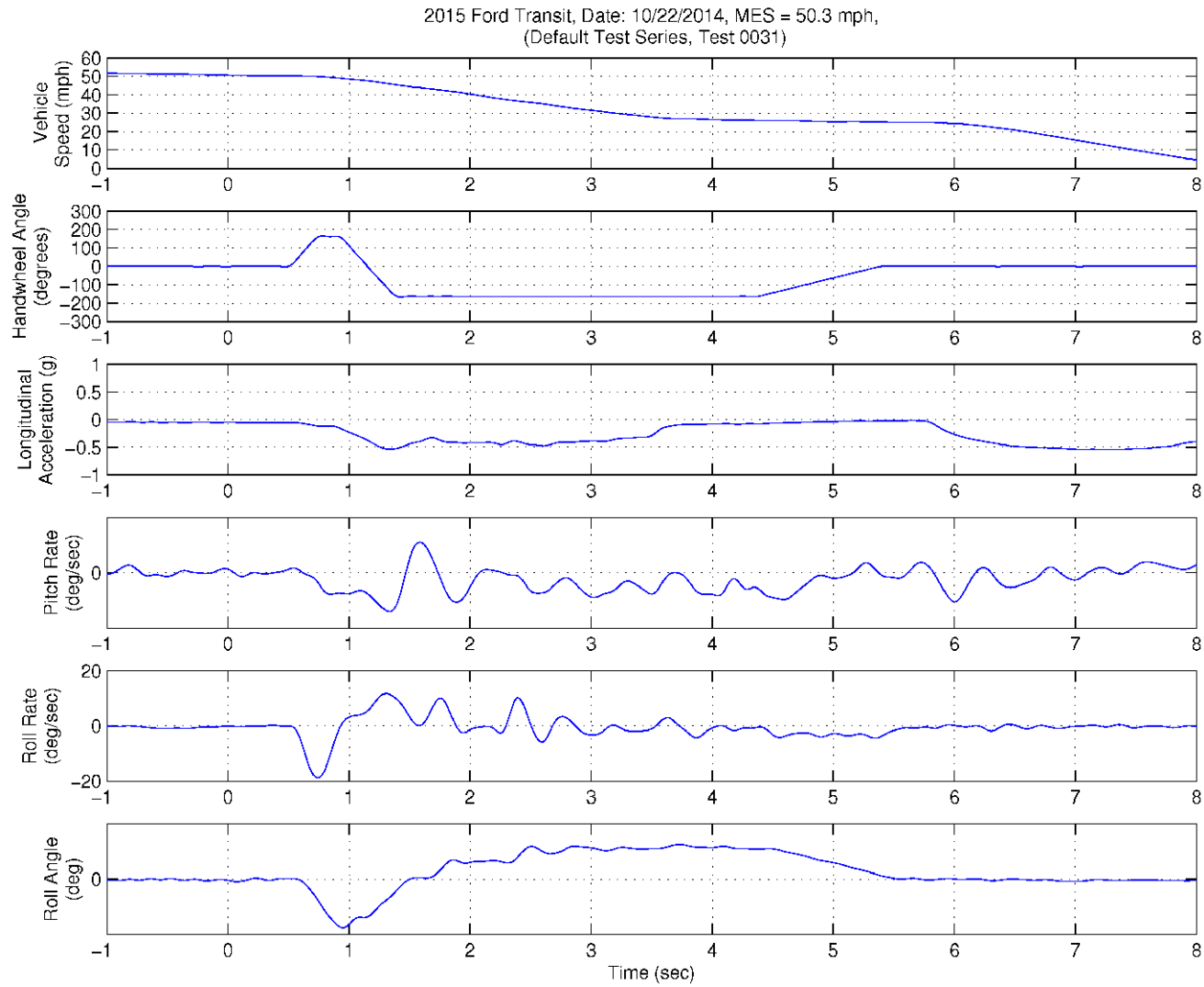

Figure D16. Pitch Rate and Longitudinal Acceleration Time History Plots for Supplemental 2 Test Series, R-L, 50 mph