

# Vehicle-to-Vehicle Communications Research Project (V2V-CR)

## DSRC and Wi-Fi Baseline Cross-channel Interference Test and Measurement Report

**-Pre-Final Version-**

*December 2019*



U.S. Department of Transportation  
National Highway Traffic Safety Administration

---

NOTE: This is a Pre-Final Version. Final version may differ slightly, and will be posted at the National Transportation Library when formatting and accessibility readiness actions are completed

Produced by Crash Avoidance Metrics Partners LLC in response to Cooperative Agreement Number DTNH22-14-H-00449

U.S. Department of Transportation  
National Highway Traffic Safety Administration

## **Notice**

This document is disseminated under the sponsorship of the Department of Transportation in the interest of information exchange. The United States Government assumes no liability for its contents or use thereof.

The U.S. Government is not endorsing any manufacturers, products, or services cited herein and any trade name that may appear in the work has been included only because it is essential to the contents of the work.

Note: This is a Pre-Final version. The Final version may differ slightly, and will be posted at the National Transportation Library when formatting and accessibility readiness actions are completed

---

---

## Technical Report Documentation Page

<b>1. Report No.</b> XX-XXX	<b>2. Government Accession No.</b> (Remove; Insert Information Here or leave blank)	<b>3. Recipient's Catalog No.</b> (Remove; Insert Information Here or leave blank)	
<b>4. Title and Subtitle</b> Vehicle-to-Vehicle Communications Research Project (V2V-CR) DSRC and Wi-Fi Baseline Cross-channel Interference Test and Measurement Report		<b>5. Report Date</b>	
		<b>6. Performing Organization Code</b> (Remove; Insert Information Here or leave blank)	
<b>7. Author(s)</b> VanSickle, S., Ahmed-Zaid, F., Krishnan, H., Khatchatrian, T., Mahmud, S., Moradi-Pari, E., Probert, N., Ahmad, S., Kamthan, S., Gallagher, B., McNew, J.		<b>8. Performing Organization Report No.</b> (Remove; Insert Information Here or leave blank)	
<b>9. Performing Organization Name And Address</b> Crash Avoidance Metrics Partners LLC on behalf of the Vehicle-Safety Communications 6 Consortium 27220 Haggerty Road, Suite D-1 Farmington Hills, MI 48331		<b>10. Work Unit No. (TRAIS)</b> (Remove; Insert Information Here or leave blank)	
		<b>11. Contract or Grant No.</b> DTNH22-14-H-00449	
<b>12. Sponsoring Agency Name and Address</b> <b>NHTSA Headquarters</b> 1200 New Jersey Avenue, SE West Building Washington, DC 20590		<b>13. Type of Report and Period Covered</b>	
		<b>14. Sponsoring Agency Code</b> (Remove; Insert Information Here or leave blank)	
<b>15. Supplementary Notes</b> (Remove; Insert Information Here or leave blank)			
<b>16. Abstract</b> This document presents test results from a set of tests that were conducted to baseline the potential performance impact of cross-channel Wi-Fi (802.11ac) emissions on Dedicated Short Range Communications (DSRC) in the DSRC band. The tests were conducted in the Crash Avoidance Metrics Partners LLC (CAMP LLC) Vehicle Safety Communications 6 (VSC6) Consortium Vehicle-to-Vehicle Communications Research (V2V-CR) Project. The Participants of the CAMP LLC VSC6 Consortium are Ford Motor Company, General Motors LLC, Honda R&D Americas, Inc., Hyundai-Kia America Technical Center, Inc., Nissan Technical Center North America, and Volkswagen Group of America. The V2V-CR Project was sponsored by the National Highway Traffic Safety Administration (NHTSA) through Cooperative Agreement No. DTNH22-14-H-00449 with the CAMP LLC.			
<b>17. Key Words</b> Vehicle-to-Vehicle, V2V, Spectrum Sharing, Dedicated Short Range Communications, DSRC, U-NII-4, SAE J2945/1, On-Board Equipment, OBE		<b>18. Distribution Statement</b> (Remove; Insert Information Here or leave blank)	
<b>19. Security Classif. (of this report)</b> (Remove; Insert Information Here or leave blank)	<b>20. Security Classif. (of this page)</b> (Remove; Insert Information Here or leave blank)	<b>21. No. of Pages</b>	<b>22. Price</b> (Remove; Insert Information Here or leave blank)

# Table of Contents

<b>Executive Summary .....</b>	<b>1</b>
<b>1 Introduction .....</b>	<b>5</b>
1.1 Background .....	5
1.2 Objectives .....	7
1.3 Scope.....	8
<b>2 Test Approach, Configurations, and Setup.....</b>	<b>10</b>
2.1 Approach .....	10
2.2 Equipment Summary.....	11
2.3 Wi-Fi and DSRC Channel Configurations .....	12
2.4 Test Setup.....	13
2.5 Test Procedure .....	15
<b>3 Captured Performance Metrics .....</b>	<b>17</b>
<b>4 Test Results .....</b>	<b>19</b>
4.1 802.11ac Duty Cycle Measurements .....	19
4.2 Characteristics of the Test Results .....	19
4.3 Cross-channel Interference Test Results .....	20
4.3.1 DSRC with 20 MHz 802.11ac on Channel 177 .....	21
4.3.2 DSRC with 40 MHz 802.11ac on Channel 175 .....	25
4.3.3 DSRC with 80 MHz 802.11ac on Channel 171 .....	29
4.3.4 DSRC with 160 MHz 802.11ac on Channel 163 .....	34
4.4 Different DSRC Radio Model Test Results .....	38
<b>5 Observations and Next Steps .....</b>	<b>42</b>
5.1 Summary Observations.....	42
5.2 Next Steps .....	42
<b>6 References .....</b>	<b>44</b>
<b>APPENDIX A. List of Acronyms .....</b>	<b>45</b>
<b>APPENDIX B. DSRC and 802.11ac Device Settings .....</b>	<b>47</b>
<b>APPENDIX C. RF Terms and Definitions .....</b>	<b>48</b>

## List of Figures

Figure 1: DSRC and Proposed U-NII-4 Radio Channels.....	6
Figure 2: DSRC and 802.11ac Channels Used in Testing.....	8
Figure 3: Outdoor Wi-Fi Hotspot Roadside Installation.....	10
Figure 4: DSRC and 802.11ac Channels Used in Cross-channel Interference Testing.....	12
Figure 5: Test Setup.....	14
Figure 6: Test Procedure – Outdoor AP Test Configuration.....	16
Figure 7: Two-Ray Model at 5.9 GHz with 5.5-meter Transmitter Antenna Height and 1.5 Meter Receiver Height.....	20
Figure 8: 802.11ac Channel Power and Spectral Occupancy Measured for Channel 177 (20 MHz) – Run 1 versus Run 2.....	21
Figure 9: 802.11ac Channel Power and Spectral Occupancy Measured for Channel 175 (40 MHz).....	26
Figure 10: 802.11ac Channel Power and Spectral Occupancy Measured for Channel 171 (80 MHz).....	30
Figure 11: 802.11ac Channel Power and Spectral Occupancy Measured for Channel 163 (160 MHz).....	34
Figure 12: 802.11ac Channel Power and Spectral Occupancy Measured for Channel 163 (160 MHz) – Different Radio Model Test.....	38
Figure 13: Transmit Spectral Mask for 802.11ac.....	48

## List of Tables

Table 1: DSRC on Channel 180 – 802.11ac Channel 177/20 MHz (Run 1 Spectral Occupancy) .....	23
Table 2: DSRC on Channel 180 – 802.11ac Channel 177/20 MHz (Run 2 Spectral Occupancy) .....	24
Table 3: DSRC on Channel 182 – 802.11ac Channel 177/20 MHz (Run 2 Spectral Occupancy) .....	25
Table 4: DSRC on Channel 184 – 802.11ac Channel 177/20 MHz (Run 2 Spectral Occupancy) .....	25
Table 5: DSRC on Channel 180 – 802.11ac Channel 175/40 MHz .....	27
Table 6: DSRC on Channel 182 – 802.11ac Channel 175/40 MHz .....	28
Table 7: DSRC on Channel 184 – 802.11ac Channel 175/40 MHz .....	29
Table 8: DSRC on Channel 180 – 802.11ac Channel 171/80 MHz .....	31
Table 9: DSRC on Channel 182 – 802.11ac Channel 171/80 MHz .....	32
Table 10: DSRC on Channel 184 – 802.11ac Channel 171/80 MHz .....	33
Table 11: DSRC on Channel 180 – 802.11ac Channel 163/160 MHz .....	35
Table 12: DSRC on Channel 182 – 802.11ac Channel 163/160 MHz .....	36
Table 13: DSRC on Channel 184 – 802.11ac Channel 163/160 MHz .....	37
Table 14: DSRC on Channel 180 – 802.11ac Channel 163/160 MHz: DSRC Radio 1 .....	40
Table 15: DSRC on Channel 180 – 802.11ac Channel 163/160 MHz: DSRC Radio 2 .....	41
Table 16: DSRC Unit Settings .....	47
Table 17: 802.11ac Device Settings .....	47

# Executive Summary

This document presents test results from a set of tests that were conducted to baseline the potential performance impact of cross-channel Wi-Fi (802.11ac) emissions on Dedicated Short Range Communications (DSRC) in the DSRC band. The tests were conducted by the Crash Avoidance Metrics Partners LLC (CAMP LLC) Vehicle Safety Communications 6 (VSC6) Consortium Vehicle-to-Vehicle Communications Research (V2V-CR) Project. The Participants of the CAMP LLC VSC6 Consortium are Ford Motor Company, General Motors LLC, Honda R&D Americas, Inc., Hyundai-Kia America Technical Center, Inc., Nissan Technical Center North America, and Volkswagen Group of America. The V2V-CR Project was sponsored by the National Highway Traffic Safety Administration (NHTSA) through Cooperative Agreement No. DTNH22-14-H-00449 with the CAMP LLC.

## Background

On February 20, 2013, the Federal Communications Commission (FCC or Commission) issued a Notice of Proposed Rulemaking (NPRM) regarding the potential use of the 5.9 GHz DSRC spectrum by Unlicensed National Information Infrastructure (U-NII) devices. As described in FCC Docket ET 13-49 [1], the FCC is considering the impacts associated with sharing of the 5.850 GHz – 5.925 GHz spectrum between DSRC and unlicensed (e.g., 802.11ac Wi-Fi) devices. Two primary interference mitigation approaches are mentioned in the FCC NPRM: “Detect and Avoid” and “Re-channelization.” “Detect and Avoid” would require no changes to DSRC technology or operation and requires unlicensed devices to avoid DSRC interference through detection of DSRC in the lower 45 MHz of the DSRC spectrum and then vacating the spectrum. “Re-channelization” would require safety-related DSRC messages to use the upper 30 MHz of the DSRC band and share the lower 45 MHz of the DSRC band between non-safety-related DSRC and unlicensed devices. The FCC NPRM, along with other related activities, led to the creation of a CAMP LLC VSC6 technical task to identify and explore potential issues related to sharing the DSRC spectrum with unlicensed devices.

## Scope

Prototype devices that support a “Detect and Avoid” or other channel sharing solutions were not available for testing. Therefore, available 802.11ac devices were modified to operate in the DSRC band and tested in combination with DSRC devices. Multiple interference test scenarios were conducted which focused on the following two testing categories:

- Co-channel Operation: The DSRC and 802.11ac channels overlap
- Cross-channel Operation: DSRC and 802.11ac operate on nearby channels

For the baseline co-channel interference testing performed in this project, significant interference to DSRC was observed in all the co-channel test configurations, as expected. A separate report was developed under this project which describes the approach and test results of the baseline co-channel interference testing and remains under review by the USDOT. This report focuses on the baseline cross-channel interference test approach and results. The cross-channel test configurations used DSRC in the upper 30 MHz of the band with Wi-Fi in the lower 45 MHz of the band. This configuration is more representative of what would be encountered with a “Re-channelization” band sharing

mechanism.<sup>1</sup> Therefore, the corresponding test results may also be more representative of a “Re-channelization” band sharing solution. The cross-channel tests were arranged as follows:

- DSRC on channel 180, 182, or 184
- 802.11ac on channel 177, 175, 171, or 163

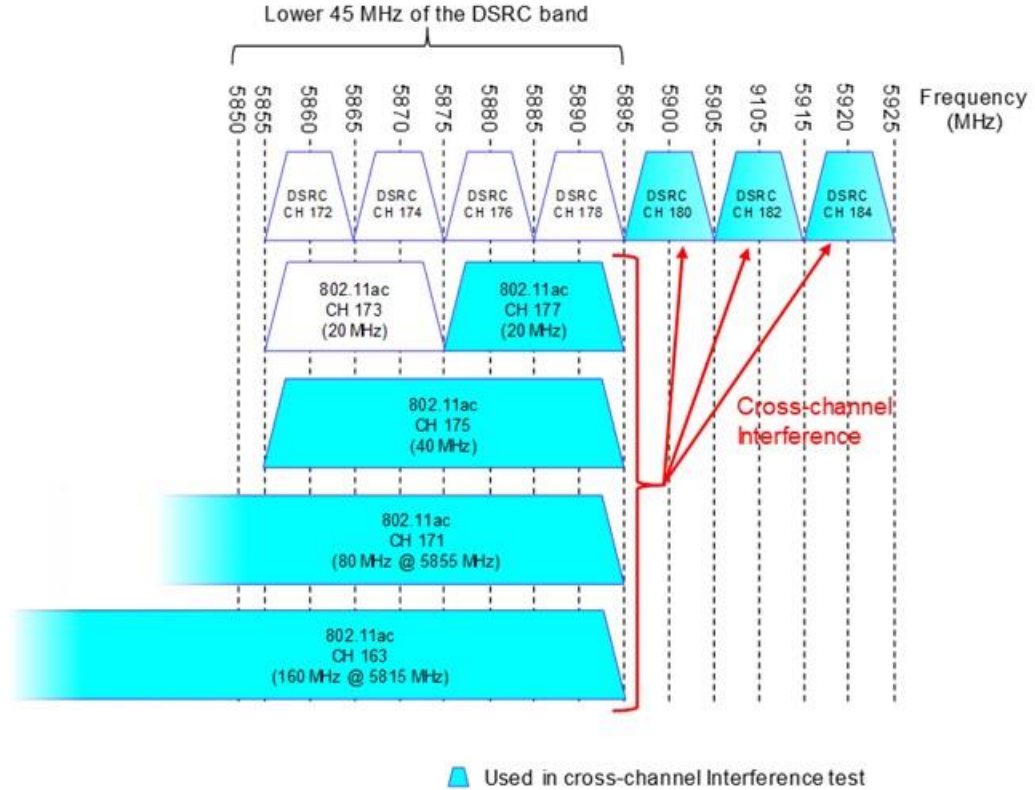

Illustration of DSRC and proposed U-NII-4 radio channels being considered by the FCC for coexistence as described in the text above.

Source: Crash Avoidance Metrics Partners LLC (CAMP) Vehicle Safety Communications 6 (VSC6) Consortium

### Test Approach, Scenario, and Procedure

The general test approach followed was:

- Collect baseline DSRC performance data (DSRC only without Wi-Fi / 802.11ac) on the desired DSRC channel in the upper 30 MHz of the DSRC band
- Introduce 802.11ac traffic on certain Wi-Fi channel(s) that overlap with the lower 45 MHz of the DSRC band
- Compare the baseline DSRC results to the combination DSRC / Wi-Fi results to assess the impact of cross-channel Wi-Fi (802.11ac) interference on DSRC

<sup>1</sup> For a “Detect and Avoid” band sharing mechanism, if DSRC is present in the upper 30 MHz of the band (i.e., channels 180 – 184), in most instances, it is likely that DSRC will also be present on channel 172 and, therefore, Wi-Fi would vacate or avoid the lower 45 MHz of the band.



The primary test scenario was an outdoor Access Point (AP) configuration to determine the baseline cross-channel interference range of an outdoor 802.11ac transmitter on DSRC. A higher-power solution was procured that enabled testing of the maximum proposed Effective Isotropic Radiated Power (EIRP) for U-NII-4 devices (i.e., 36 dBm) as it represents a use-case like the high-power APs being installed by cable companies in the U-NII-3 band. The configuration selected is one where the AP / hotspot sits right above or adjacent to the roadway, and, thus, is a potential concern for V2V DSRC communications should spectrum sharing become a reality.

For these tests, two DSRC-equipped vehicles (sedans) were positioned 75 meters apart resulting in a near vehicle and far vehicle with respect to the distance to the AP. Both the near and far vehicles were moved in 25-meter increments from the AP. The distance from the near vehicle to the 802.11ac AP varied from 0 to 500 meters, depending on the observed cross-channel interference range of the test. All these tests left the baseline DSRC V2V distance of 75 meters unmodified which substantiates comparison of cross-channel interference scenarios to the baseline DSRC scenarios. While it is recognized that that this led to stronger DSRC Received Signal Strength (RSS) levels than would be experienced at longer ranges or in non-line-of-sight (NLOS) environments, a primary purpose of the testing was a first characterization of the potential cross-channel interference range of 802.11ac devices to DSRC performance.

Most of the tests were based on a test configuration that used a DSRC device with a radio compliant with the Society of Automotive Engineers International (SAE) J2945/1 [5] specified standard adjacent and non-adjacent channel rejection (ACR / nACR) requirements. Just prior to the testing, a different DSRC device with a radio reported to have improved ACR / nACR requirements was acquired. So, in addition, a preliminary, single adjacent-channel test was conducted for comparison purposes between these two variants of DSRC radios.

### **Test Results Summary**

The following performance metrics were determined for each test case:

- Channel Busy Percentage (CBP)
- Packet Error Rate (PER)
- Information Age (IA)

These performance metrics have historically been used in the development of vehicle safety applications, and they are also used as inputs to the congestion control algorithm that manages congestion on the wireless medium (see SAE J2945/1 [5]).

Cross-channel test results showed the potential for cross-channel interference, having an impact on DSRC performance, up to a range of 500 meters or more, but typically between 200 and 300 meters. However, the results also generally showed that the closer the spectral occupancy was to the 802.11ac spectral mask requirements, the greater the cross-channel interference impact to DSRC performance. Not all the tests were able to achieve a spectral occupancy close to the mask spectral requirements.

When testing a different DSRC radio with improved cross-channel receive rejection (ACR / nACR) characteristics, for the one test run, the cross-channel interference range was shorter. However, these results should be considered preliminary pending controlled lab tests to characterize the receiver and potentially other RF performance of the radios along with additional field testing. It should be noted that SAE J2945/1 requires the standard ACR and nACR as a minimum requirement. Requiring enhanced ACR would require a change to that Standard. Also, the possibility exists for aftermarket,

personal, and other DSRC devices to be deployed in which the enhanced parameters may not be achievable.

### **Next Steps**

Some of the items that future testing for characterizing coexistence will include are:

- Characterizing in detail the performance of DSRC radios with higher performance receivers
- Acquiring variable attenuators to enable better control / repeatability in obtaining the desired spectral occupancy
- Gain access to broader range of 802.11ac settings for deeper analysis (e.g., modulation/rate control and packet aggregation thresholds)
- Testing with various 802.11ac traffic patterns (e.g., streaming video)
- Testing at more realistic DSRC link RSS values, which are more representative of DSRC's required performance capabilities

# 1 Introduction

This document presents test results from a set of tests that were conducted to baseline the potential performance impact of cross-channel Wi-Fi (802.11ac) emissions on Dedicated Short Range Communications (DSRC) in the DSRC band. The tests were conducted by the Crash Avoidance Metrics Partners LLC (CAMP LLC) Vehicle Safety Communications 6 (VSC6) Consortium Vehicle-to-Vehicle Communications Research (V2V-CR) Project. The Participants of the CAMP LLC VSC6 Consortium are Ford Motor Company, General Motors LLC, Honda R&D Americas, Inc., Hyundai-Kia America Technical Center, Inc., Nissan Technical Center North America, and Volkswagen Group of America. The V2V- CR Project was sponsored by the National Highway Traffic Safety Administration (NHTSA) through Cooperative Agreement No. DTNH22-14-H-00449 with the CAMP LLC.

## 1.1 Background

On February 20, 2013, the Federal Communications Commission (FCC or Commission) issued a Notice of Proposed Rulemaking (NPRM) regarding the potential use of the 5.9 GHz DSRC spectrum by Unlicensed National Information Infrastructure (U-NII) devices. As described in FCC Docket ET 13-49 [1], the FCC is considering the impacts associated with sharing of the 5.850 GHz – 5.925 GHz spectrum between DSRC and unlicensed (e.g., 802.11ac Wi-Fi) devices. This spectrum was originally allocated as co-primary for DSRC use by the transportation community in the FCC’s Report and Order, adopted on December 17, 2003 (FCC document 03-324) [2]. It included the requirement that DSRC co-exist with the other primary users such as military radar, satellite uplinks, and indoor industrial, scientific, and medical. DSRC uses a signal that is based on the American Society for Testing and Materials (ASTM) 2213-03 and the Institute of Electrical and Electronics Engineers (IEEE) 802.11p [6] standards. The unlicensed devices, proposed by the FCC NPRM for sharing the band, include signals based on IEEE 802.11ac [7] and potentially other signals such as unlicensed Long Term Evolution (LTE). These unlicensed devices would operate in what was proposed by the FCC as the U-NII-4 band.

In furtherance of its efforts, on June 1, 2016, the FCC released a public notice asking interested parties to update and refresh the record on the status of potential sharing solutions between proposed U-NII devices and DSRC operations in the 5.850 GHz – 5.925 GHz band [3]. In so doing, the FCC noted Congress’s attention to the issue raised in the Commission’s proceeding about potential spectrum sharing and recognized the work that had been performed by the United States Department of Transportation (USDOT) and other stakeholders to improve the Commission’s understanding of the issues.

The DSRC and proposed U-NII-4 (per the FCC NPRM in docket 13-49 for 802.11ac) radio channels being considered by the FCC for coexistence are shown in Figure 1 (note that the current understanding is that 802.11ac channel 181 is no longer being requested by the unlicensed stakeholders).<sup>2</sup> Two primary interference mitigation approaches are mentioned in the FCC NPRM: “Detect and Avoid” and “Re-channelization.” “Detect and Avoid” would require no changes to DSRC

---

<sup>2</sup>Refer to FCC Docket 13-49 [1] submissions for more details on inputs to the FCC regarding band sharing and the proposed U-NII-4 allocation.

technology or operation and requires unlicensed devices to avoid DSRC interference through detection of DSRC in the lower 45 MHz of the DSRC spectrum and then vacating the spectrum. “Re-channelization” would require safety-related DSRC messages to use the upper 30 MHz of the DSRC band and share the lower 45 MHz of the DSRC band between non-safety-related DSRC and unlicensed devices.

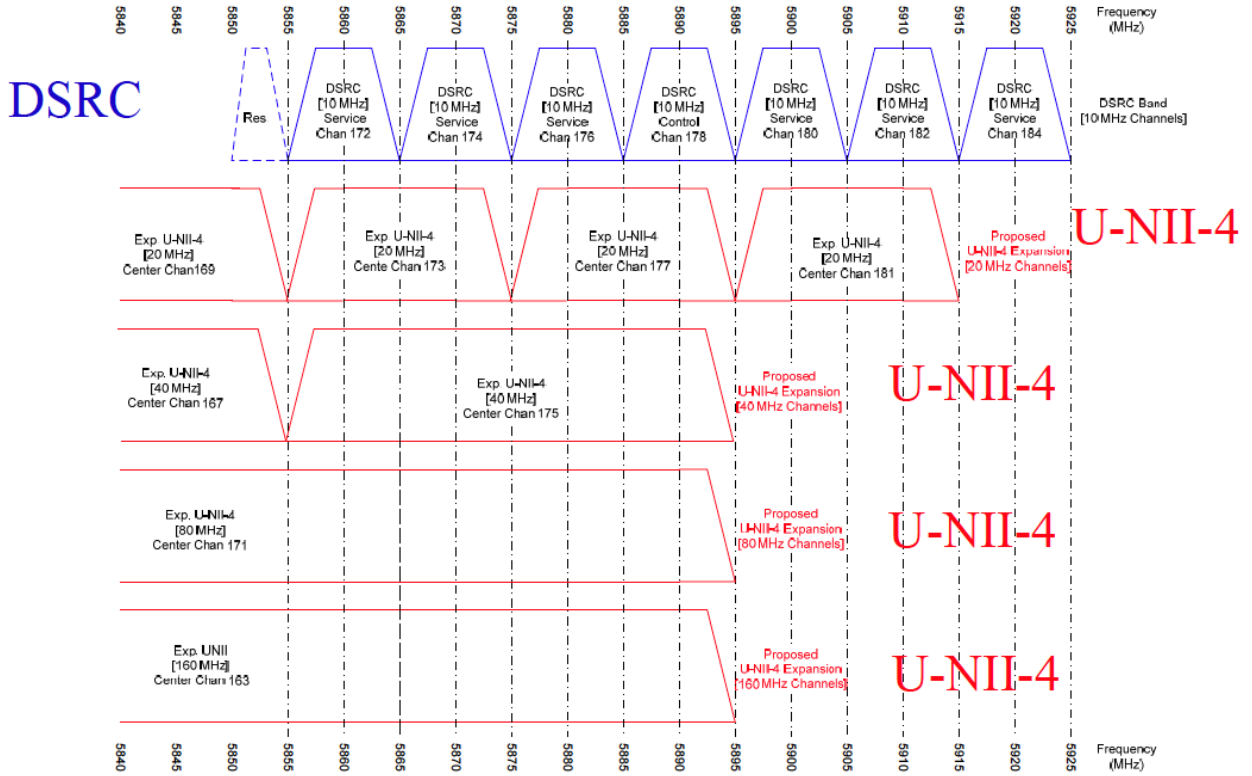

Source: FCC Docket 13-49 Submissions

**Figure 1: DSRC and Proposed U-NII-4 Radio Channels**

The FCC NPRM, along with other related activities, led to the creation of a CAMP LLC VSC6 technical task to identify and explore potential issues related to sharing the DSRC spectrum with unlicensed devices. The CAMP LLC VSC6, and previous CAMP consortia, have invested significant effort in Vehicle-to-Vehicle (V2V) safety, Vehicle-to-Infrastructure (V2I) safety and other related DSRC research, development, and test activities. The various CAMP LLC consortia have developed both V2V and V2I safety applications; integrated On-Board Equipment (OBE) devices which support these applications using DSRC into light passenger vehicles; performed controlled test track and real-world road testing of these applications; and have been active in the DSRC standards development. In the recent past they have:

- Held six Driver Acceptance Clinics (DACs) in which volunteers drove vehicles equipped with V2V safety applications on a closed test track under controlled conditions to experience the V2V safety applications at various locations in the United States to obtain data about driver acceptance of communication-based V2V safety systems
- Deployed 64 Integrated Light Vehicles (ILVs) into the USDOT Safety Pilot Model Deployment environment in Ann Arbor, Michigan driven by naive participants for just under a year to,

among other things, assess the V2V safety applications in a naturalistic, real-world environment

- Performed numerous Global Positioning System (GPS) test track and field performance tests
- Developed and implemented promising congestion control protocols to support V2V safety communications for deployment levels of vehicles and ultimately selected one of the protocols for standardization in the Society of Automotive Engineers International (SAE) J2945/1 [5] standard. This work included:
  - Planned and executed a number of large-scale field tests utilizing up to 400 OBEs to test these protocols
  - Developed a channel model for one of the field test environments
  - Performed two independent communications simulator calibration efforts to the channel model
  - Used the simulators to support further development, test, and analysis of the protocols
  - Built a DSRC “Communications Scalability Lab” to house the 400 OBEs
- By leveraging all of the above, were instrumental in the development and definition of the SAE J2735 [4] Basic Safety Message (BSM) and the development and release of the SAE J2945/1 [5] system requirements for an on-board V2V safety communications system for light vehicles

## 1.2 Objectives

Prototype devices that support a “Detect and Avoid” or other channel sharing solution were not available for testing. Therefore, available 802.11ac devices were modified to operate in the DSRC band (according to Figure 1) and tested in combination with DSRC devices. The primary objectives of the testing included:

- Obtain Wi-Fi (802.11ac) devices capable of operating in the DSRC band and become familiar with their operation
- In various test environments and configurations, operate Wi-Fi (802.11ac) and DSRC devices in different channel configurations
- Use the results of the tests to establish baseline interference characteristics of Wi-Fi (802.11ac) emissions on DSRC messaging performance
- Through the experience gained, be prepared to test actual coexistence (e.g., “Detect and Avoid”) prototypes when / if they become available<sup>3</sup>

---

<sup>3</sup> Note that at the time of submission of this report, “Detect and Avoid” and priority-based coexistence prototype devices had not yet been made available for testing possible coexistence solutions other than re-channelization.

## 1.3 Scope

Multiple interference test scenarios were conducted to determine the impact of 802.11ac on DSRC performance when “coexisting” in the same band. For the purposes of this project, coexistence means that both 802.11ac and DSRC are sharing the 5.850 GHz to 5.925 GHz spectrum, and the respective 802.11ac and DSRC channels may be overlapping or, alternatively, non-overlapping but operating in bands near or adjacent to each other. Hence, the project included two testing categories:

- Co-channel Operation: The DSRC and 802.11ac channels overlap (e.g., DSRC channel 172 and 802.11ac channel 163)
- Cross-channel Operation: DSRC and 802.11ac operate on nearby channels (e.g., DSRC channel 180 and 802.11ac channel 177)

The various combinations of 802.11ac and DSRC channels tested are illustrated in Figure 2.

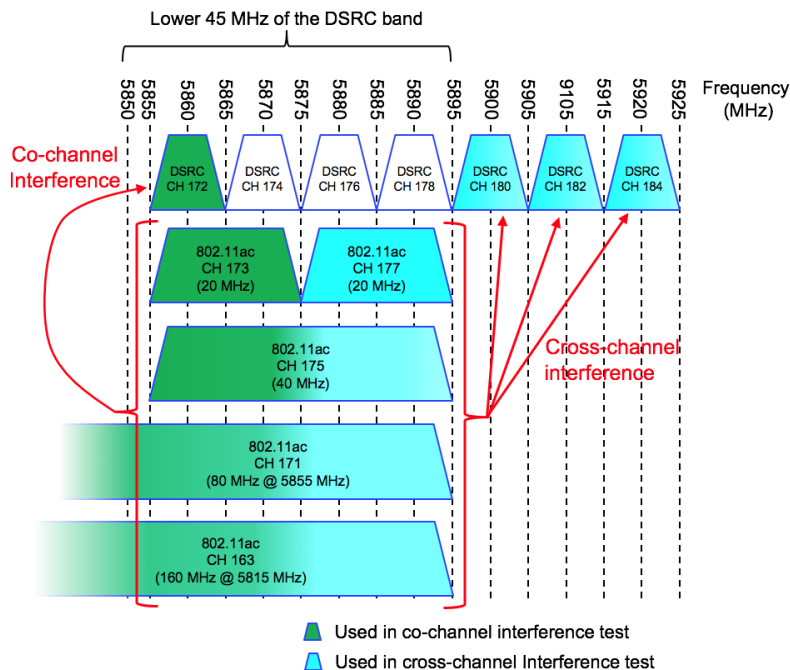

Source: Crash Avoidance Metrics Partners LLC (CAMP) Vehicle Safety Communications 6 (VSC6) Consortium

**Figure 2: DSRC and 802.11ac Channels Used in Testing**

For the baseline co-channel interference testing performed in this project, significant interference to DSRC was observed in all the co-channel test configurations, as expected. However, given that the 802.11ac devices did not employ a channel sharing mechanism, those results will not be discussed in this report. They may be released later, pending the availability of devices equipped with a sharing mechanism. This will allow for a comparison of the baseline co-channel results with the actual coexistence device co-channel interference results.

Instead, this report will focus only on the cross-channel test results. The cross-channel test configurations used DSRC in the upper 30 MHz of the band with Wi-Fi in the lower 45 MHz of the band. This configuration is more representative of what would be encountered with a “Re-

channelization” band sharing mechanism<sup>4</sup>. Therefore, the corresponding test results may also be more representative of a “Re-channelization” band sharing solution.

---

<sup>4</sup> For a “Detect and Avoid” band sharing mechanism, if DSRC is present in the upper 30 MHz of the band (i.e., channels 180 – 184), in most instances, it is likely that DSRC will also be present on channel 172 and, therefore, Wi-Fi would vacate or avoid the lower 45 MHz of the band.

## 2 Test Approach, Configurations, and Setup

Given the vast number of possible test scenarios comprising indoors, outdoors, channels of operation, and bandwidth sizes, the set of combinations used in both the co-channel and the cross-channel testing were representative of potential coexistence scenarios. However, for the cross-channel testing, which is the focus of this report, the primary scenario was an outdoor Access Point (AP) configuration to determine the interference range of an outdoor 802.11ac transmitter on DSRC. This scenario was selected because it represents an outdoor Wi-Fi use case where cable companies are currently deploying outdoor Wi-Fi hotspots to be accessed by their customers. The configuration selected is one where the AP / hotspot sits right above or adjacent to the roadway and thus is a potential concern for V2V DSRC communications should spectrum sharing become a reality. Figure 3 shows one of these outdoor Wi-Fi hotspots in suburban Des Plaines, Illinois.



Source: © 2018 Google Inc, used with permission. Google and the Google logo are registered trademarks of Google Inc.

**Figure 3: Outdoor Wi-Fi Hotspot Roadside Installation**

The following sections discuss the approach, configuration, and setup of the testing.

### 2.1 Approach

The general approach followed was:

- Collect baseline DSRC performance data (DSRC only without Wi-Fi / 802.11ac) on the desired DSRC channel in the upper 30 MHz of the DSRC band
- Introduce 802.11ac traffic on certain Wi-Fi channel(s) that overlap with the lower 45 MHz of the DSRC band (the cross-channel noise needed for DSRC interference assessment)



- For each DSRC / Wi-Fi cross-channel combination, run tests for a length of time sufficient for obtaining enough BSM samples for data analysis
- Compare the baseline DSRC results to the combination DSRC / Wi-Fi results to assess the impact of cross-channel Wi-Fi (802.11ac) interference on DSRC

As a setup condition, the two 802.11ac units were paired and an open source Internet Protocol (IP) traffic generator was used to generate data traffic between them. This approach provided a baseline level of cross-channel interference emissions using the maximum throughput available on the 802.11ac links (up to approximately 90% duty cycle from the AP on the channel)<sup>5</sup>. The data traffic input to the 802.11ac devices was a stream of 1400-byte packets that result in varying lengths of over the air packets, depending on how 802.11ac applies packet aggregation. No specific controls were applied to the data rate or packet lengths used by the 802.11ac units. They were configured for normal Medium Access Control (MAC) and Physical Layer (PHY) operation in which the data rates (modulation and coding) and packet aggregation were applied naturally per 802.11ac standards. The focus of the testing was on interference and did not account for network traffic patterns of wireless Local Area Networks (LANs).

The test configuration enabled increasing the 802.11ac transmit signal to as close to the maximum allowed by the FCC as possible, i.e., 36 dBm Effective Isotropic Radiated Power (EIRP) (see APPENDIX C for a definition and description of EIRP). This higher power was achieved by using a bi-directional amplifier (BDA) between the Radio Frequency (RF) output of the 802.11ac AP and its antenna.

For DSRC, BSMs were transmitted by all DSRC units at a rate of 10 messages per second. Each BSM was approximately 300 to 200 bytes in size depending on if a full security certificate or certificate digest was being represented. Test durations were at least 100 seconds to ensure that at least 1000 BSMs could be transmitted by each DSRC unit for data analysis.

More information on the settings of the DSRC units and 802.11ac devices is provided in APPENDIX B.

## 2.2 Equipment Summary

Following is a summary of the equipment that was used for the tests:

- RF spectrum analyzer
- Laptop(s) to configure the 802.11ac and DSRC radios
- Two DSRC-equipped vehicles – For outdoor drive testing and in-vehicle testing
- Two 802.11ac radios (one AP and one client)
- 5 – 6 GHz antennas, masts, etc. for 802.11ac

---

<sup>5</sup> Note that because of the Enhanced Distributed Channel Access (EDCA) parameter Arbitration Interframe Space Number (AIFSN) and minimum Contention Window (CW<sub>min</sub>) settings used for typical traffic (best effort) in an 802.11ac network (see APPENDIX B), even with somewhat lower duty cycles, the expected DSRC wait time to access the channel is higher than 802.11ac, and thus it is less likely that DSRC traffic will be transmitted in time for an 802.11ac device to detect it and back off.

- One BDA used to increase the power and spectral occupancy of the 802.11ac AP signal to levels consistent with the proposed U-NII-4 band
- RF cables, coupler and attenuators to support the new configuration
- Channel Busy Percentage (CBP) measurement sensor
  - DSRC radio used to measure 802.11ac duty cycle
    - High input level used to ensure accurate measurement

The 802.11ac units are compliant with IEEE 802.11ac transmit spectral masks and, as noted, approximately support the maximum EIRP allowed by the FCC and considered for proposed U-NII-4 devices (see APPENDIX C for a definition and description of spectral mask).

## 2.3 Wi-Fi and DSRC Channel Configurations

Depending on the test being performed, one of the 802.11ac channels and one of the DSRC channels shown in Figure 4 were used. Each interfering 802.11ac and DSRC channel pair was tested individually (i.e., DSRC was not transmitting on multiple channels simultaneously). The cross-channel tests were arranged as follows:

- DSRC on channel 180, 182, or 184
- 802.11ac on channel 177, 175, 171, or 163

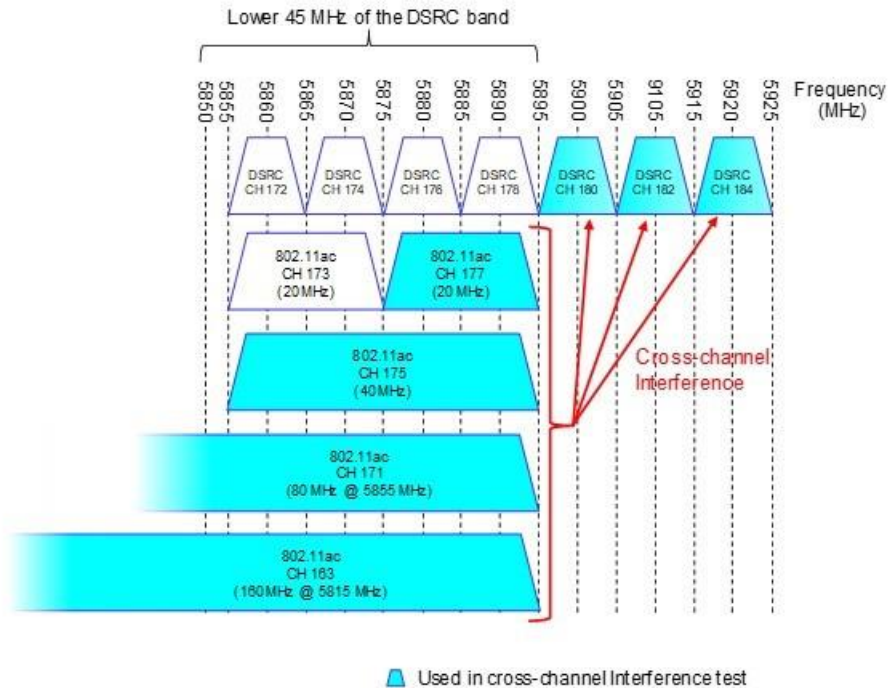

Source: Crash Avoidance Metrics Partners LLC (CAMP) Vehicle Safety Communications 6 (VSC6) Consortium

**Figure 4: DSRC and 802.11ac Channels Used in Cross-channel Interference Testing**

Henceforth, proposed U-NII-4 channel 163 will correspond to 160 MHz bandwidth, proposed U-NII-4 channel 171 corresponds to 80 MHz bandwidth, proposed U-NII-4 channel 175 corresponds to 40 MHz bandwidth and proposed U-NII-4 channel 177 correspond to 20 MHz bandwidth.

## 2.4 Test Setup

The 802.11ac AP was connected to its antenna through the BDA and the power was adjusted to achieve 32 to 33 dBm to compensate for cable and connector loss to the antenna. Approximately 3 dB of cable/connector loss was observed, so the input was compliant with maximum FCC conducted power into the antenna (30 dBm) (see APPENDIX C for a definition and description of conducted transmit power). With an antenna gain of 6 dBi, this provided as close to 36 dBm EIRP as possible. A diagram of the setup is shown in Figure 5.

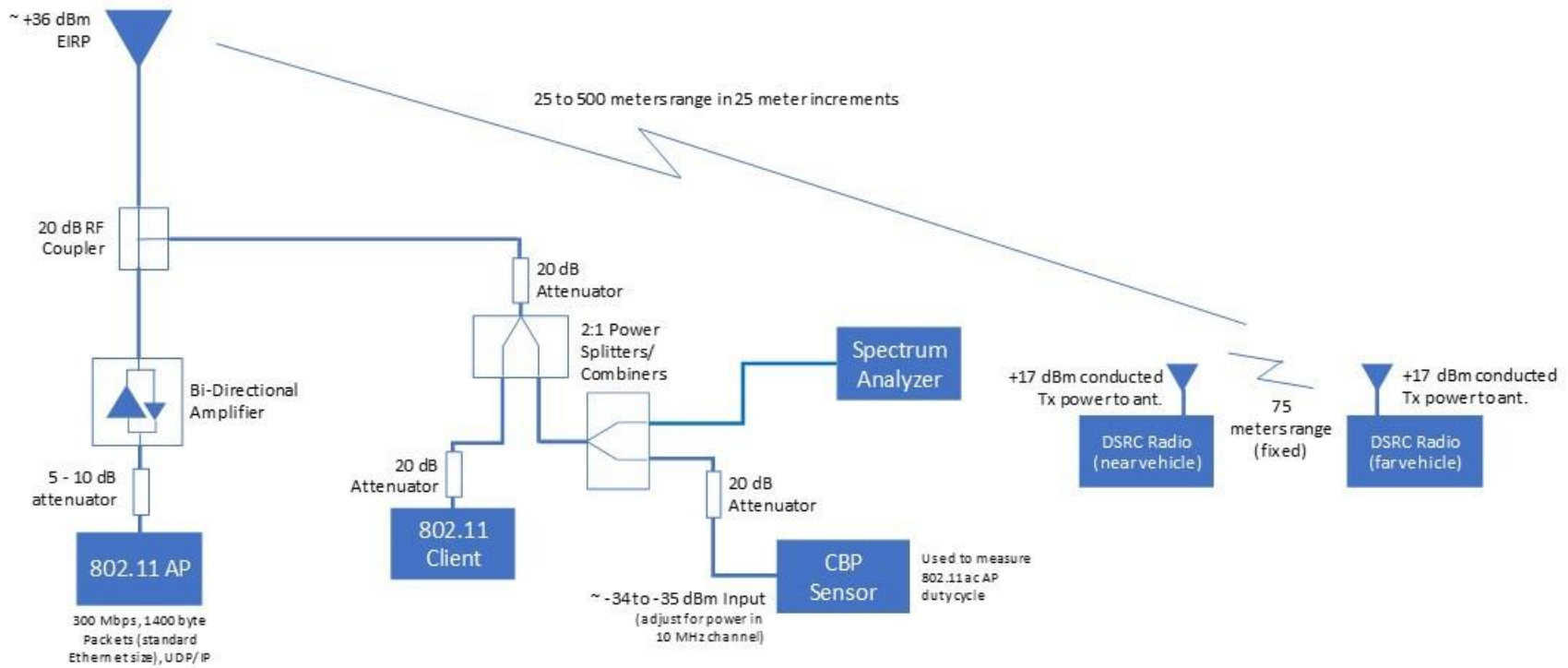

Source: Crash Avoidance Metrics Partners LLC (CAMP) Vehicle Safety Communications 6 (VSC6) Consortium

**Figure 5: Test Setup**

The test setup was constructed so that the 802.11ac client would only be visible to the 802.11ac AP. This is accomplished by using a wired RF connection between the AP and client to isolate the signal from the client (i.e., the RF emissions from the client were not detectable by the DSRC radios).

Using a series of splitters and attenuators, the 802.11ac client and CBP measurement sensor (“CBP Sensor”) were connected to the 802.11ac AP. The CBP measurement sensor was used to measure the 802.11ac duty cycle of the AP. It was a DSRC radio, and the setup was configured so that the power into the sensor was very high to ensure accurate measurement. The purpose of the attenuators was to decrease the level of input signal to the 802.11ac client and CBP measurement sensor to a level that was slightly below the maximum RF input capability of those radios. Note that the coupler between the BDA and 802.11ac AP antenna provides 20 dB of attenuation to the chain where the 802.11ac client and CBP measurement sensor are connected, but the corresponding attenuation between the AP and its antenna was less than 0.2 dB (the purpose of an RF coupler is to provide an attenuated output/input between a radio and RF measurement equipment while not reducing the transmit/receive levels between that radio and its antenna).

The attenuator between the 802.11ac AP and BDA varied depending on the channel bandwidth of the 802.11ac signal. For each test run, a trial and error approach was used to achieve a transmit spectral occupancy that was as close to the defined mask as possible. This was achieved using a combination of attenuation and adjusting the output power settings on 802.11ac AP.

A spectrum analyzer was included in the setup to provide real-time measurement of the output power and RF spectral occupancy of the 802.11ac AP. The spectrum analyzer was calibrated to account for the coupler, attenuators and splitters (each splitter results in approximately 3 dB of loss between the input and outputs).

Finally, the DSRC radios were set up to provide +20 dBm of power into the cable leading to the DSRC antenna mounted on the roof of the DSRC vehicles. There was ~3 dB of cable loss which resulted in ~17 dBm of conducted power to the DSRC antenna. A complete set of 802.11ac and DSRC device settings is provided in APPENDIX B.

Other test configuration information:

- 802.11ac AP antenna gain of 6 dBi
- 802.11ac AP antenna height of approximately 5.5 meters
- DSRC antenna height of approximately 1.5 meters

## 2.5 Test Procedure

Figure 6 illustrates the test procedure, which used the outdoor AP test configuration. For these tests, two DSRC-equipped vehicles (sedans) were positioned 75 meters apart resulting in a near vehicle and far vehicle with respect to the distance to the AP. Both the near and far vehicles were moved in 25-meter increments from the AP (the distance between vehicles, 75 meters, remained constant). The distance from the near vehicle to the 802.11ac AP varied from 0 to 500 meters, depending on the observed cross-channel interference range of the test.

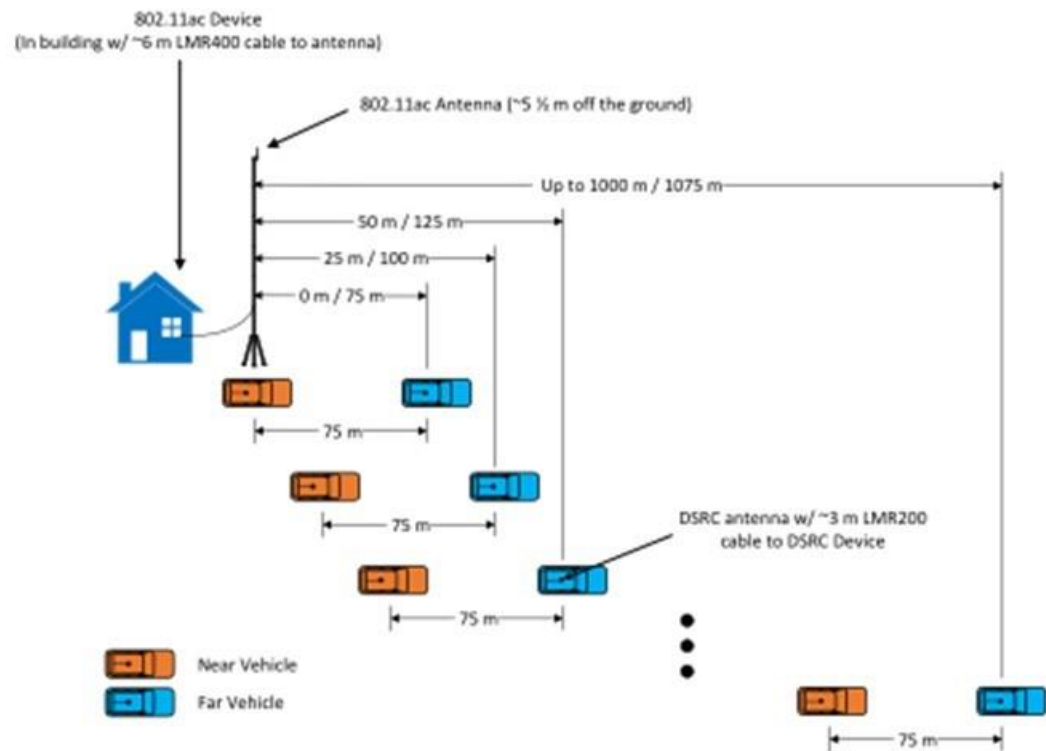

Source: Crash Avoidance Metrics Partners LLC (CAMP) Vehicle Safety Communications 6 (VSC6) Consortium

**Figure 6: Test Procedure – Outdoor AP Test Configuration**

## 3 Captured Performance Metrics

The following performance metrics were captured for the tests presented herein. For each DSRC / 802.11ac Wi-Fi configuration under test, a timestamp was captured at the beginning of the tests, and then the data was averaged over the following 100 seconds of the test. These metrics are:

- Channel Busy Percentage (CBP) – Ratio, expressed as a percentage, of the time during which the wireless channel is busy (i.e., energy level is higher than the carrier sensing threshold) to the period of time over which CBP is being measured (see [5]). CBP is measured at each vehicle based on:
  - Packets being transmitted by the vehicle
  - Packets being received from the other vehicle
  - Interference detected from the 802.11ac AP
- Packet Error Ratio (PER) – Ratio, expressed as a percentage, of the number of missed packets at a receiver from a transmitter and the total number of packets queued at that transmitter. Note that PER is undefined if the DSRC receiver does not receive at least 2 BSMs during the measurement interval (i.e., 100 seconds in these tests). Also, note that the PER metric in this case includes:
  - Packet loss due to packets that were dropped from the transmit queue because a newer BSM arrived in the queue before the previous BSM could be transmitted due to the medium being busy (the DSRC radio's clear channel assessment could not detect that the medium was clear for transmitting before the next packet arrived)
  - Packets lost over the air due to collisions or insufficient signal strength

The difference between the different types of packet loss affecting the PER is not distinguished in this report. PER for each vehicle is calculated as follows:

- PER for the far vehicle is calculated based on the number of packets transmitted by the far vehicle that are not received by the near vehicle
- PER for the near vehicle is calculated based on the number of packets transmitted by the near vehicle that are not received by the far vehicle
- Information Age (IA) – IA represents the time interval, expressed in milliseconds, between the current time at a receiver and the timestamp, applied by the transmitter, corresponding to the data (e.g., position, speed, heading) contained in the most recently received BSM from the transmitter. IA for each vehicle is calculated as follows:
  - IA for the far vehicle is calculated based on BSMs received by the near vehicle that are transmitted by the far vehicle
  - IA for the near vehicle is calculated based on BSMs received by the far vehicle that are transmitted by the near vehicle

In addition, the following was captured for each test:

- Received Signal Strength (RSS) – The average estimated received signal strength of BSMs that were successfully decoded
  - RSS for the far vehicle is calculated over the preamble of the packets received by the near vehicle that are transmitted by the far vehicle

- RSS for the near vehicle is calculated over the preamble of the packets received by the far vehicle that are transmitted by the near vehicle



## 4 Test Results

As noted previously, the test results presented in this section are based only on cross-channel interference caused by the 802.11ac AP, with the maximum proposed allowable transmit power (36 dBm). Cross-channel test results are presented with varying ranges, in meters, between the AP and the DSRC device, depending on the cross-channel interference distance that was observed to impact DSRC performance in the testing. In each cross-channel test, data was collected beyond the distance that cross-channel interference was observed so that the maximum cross-channel interference range was determined for each test. For each test, the baseline DSRC performance results (DSRC only without 802.11ac Wi-Fi) are presented along with the results when 802.11ac Wi-Fi traffic is introduced on certain Wi-Fi channel(s). The baseline DSRC results (i.e., no Wi-Fi present) are consistent with the expected performance of DSRC for the corresponding test configurations.

All these tests left the baseline DSRC V2V distance of 75 meters unmodified which substantiates comparison of cross-channel interference scenarios to the baseline DSRC scenarios. As will be seen in the results tables, this resulted in a V2V DSRC link with received BSM RSS levels of approximately -69 dBm (the minimum required RSS as called for by SAE J2945/1 is -92 dBm). It is recognized that this does not represent the link levels that would be experienced at longer ranges or in non-line-of-sight (NLOS) environments such as those with buildings blocking corners, traffic with blocking vehicles, etc. However, a primary purpose of the testing was a first characterization of the potential cross-channel interference range of 802.11ac devices to DSRC performance.

### 4.1 802.11ac Duty Cycle Measurements

For each 802.11ac bandwidth, the following data, which corresponds to the 802.11ac AP transmit duty cycle, was collected from the CBP sensor:

- 20 MHz: 91 – 92%
- 40 MHz: 89%
- 80 MHz: 85%
- 160 MHz: 62 – 64% with occasional measurements above 70%

The reason for the decrease in duty cycle with higher bandwidth 802.11ac is not precisely known, but it is likely due to packet aggregation and other features of 802.11ac. Settings, such as packet aggregation parameters, were not available for adjustment in this round of testing but if further testing is conducted (see Section 5.2 – Next Steps), more control over the 802.11ac settings is planned. In addition, even with the lower duty cycle for 160 MHz channels, as will be seen in the forthcoming test results sections, the PER for DSRC was still high. This could be due to several 802.11ac features and settings, such as Enhanced Distributed Channel Access (EDCA) parameters.

### 4.2 Characteristics of the Test Results

This section will discuss characteristics of the testing that may be observed in some of the test results and is intended to help with understanding aspects of the results that otherwise may look anomalous.

- Some dips in PER and other performance metrics may be observed at some vehicle to AP distances due to cancelling reflections of the 802.11ac AP signal from the road surface

(commonly observed according to a two-ray path loss model with a ground reflection). When noticeably present, this reflection effectively reduces the signal level of the 802.11ac AP at the DSRC antenna, thus reducing the impact to the V2V DSRC.

Figure 7 contains a two-ray model calculation for a concrete surface (note there can be some variation in the model depending on what the permittivity and conductivity of the reflecting material is) where the channel gain represents the path loss associated with the 802.11ac AP signal with an antenna height of 5.5 meters and a DSRC antenna on the vehicle at a height of 1.5 meters to be consistent with the AP test setup used. In this figure, the distance at which the cancelling affect occurs is between 175 and 200 meters from the AP. Given the approximate distance at which the cancellation takes place, this effect is only exhibited in tests where the cross-channel interference range went beyond 200 meters from the AP.

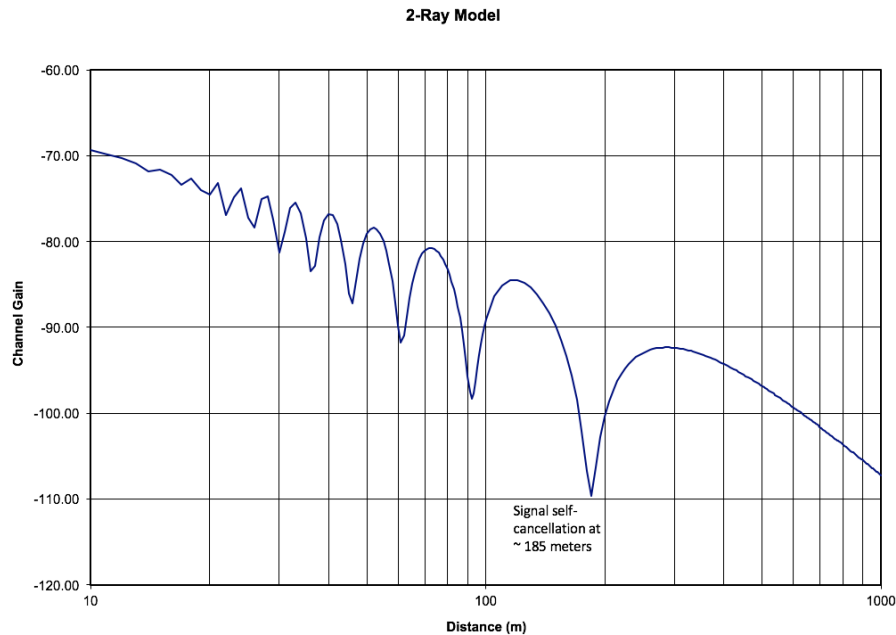

Source: JMC Rota Inc.

**Figure 7: Two-Ray Model at 5.9 GHz with 5.5-meter Transmitter Antenna Height and 1.5 Meter Receiver Height**

- When the near vehicle is next to the 802.11ac AP antenna mast, the DSRC performance may be better than at 25 meters because the antenna pattern of the 802.11ac AP antenna rolls off sharply below the antenna, near the base of the mast. This is sometimes referred to as the “umbrella effect.”

### 4.3 Cross-channel Interference Test Results

In this section, cross-channel interference test results are presented. Each subsection contains a screenshot of the spectrum analyzer showing the 802.11ac AP spectral occupancy (shown in yellow in Figure 8 through Figure 12) compared to the corresponding spectral mask (shown in red in Figure 8 through Figure 12). Refer to APPENDIX C for descriptions of these terms. The closer the spectral occupancy to the spectral mask the higher the potential for cross-channel interference. A compliant spectral occupancy represents the case when the Power Spectral Density (PSD) of the radio

transmission is always below the spectral mask (see APPENDIX C). These interference tests were always conducted with a passing (compliant) 802.11ac spectral occupancy measurement (note the green PASS in the upper left corner).

Again, note that for each test the conducted transmit power was calibrated to achieve 32 to 33 dBm, which when combined with cable loss and antenna gain provided as close to 36 dBm EIRP as possible.

### 4.3.1 DSRC with 20 MHz 802.11ac on Channel 177

Multiple runs were conducted for cross-channel interference between DSRC channel 180 and 802.11ac channel 177, and two runs are presented here. For the first run, the 802.11ac spectral occupancy was very close to the proposed limits (yellow curve - Figure 8, left side). After the first run, the system was recalibrated due to a connector failure during subsequent runs. For the second run of DSRC on channel 180, the 802.11ac spectral occupancy (yellow curve - Figure 8, right side) was not as close to the proposed limits versus the occupancy achieved in Run 1. The results (presented in the coming sections) are reflective of the difference between the two spectral occupancy measurements. There is a steeper roll-off for Run 2 versus Run 1 which means the level of the interfering signal in the adjacent DSRC channel 180 was lower for Run 2 (i.e., there was less cross-channel interference in Run 2).

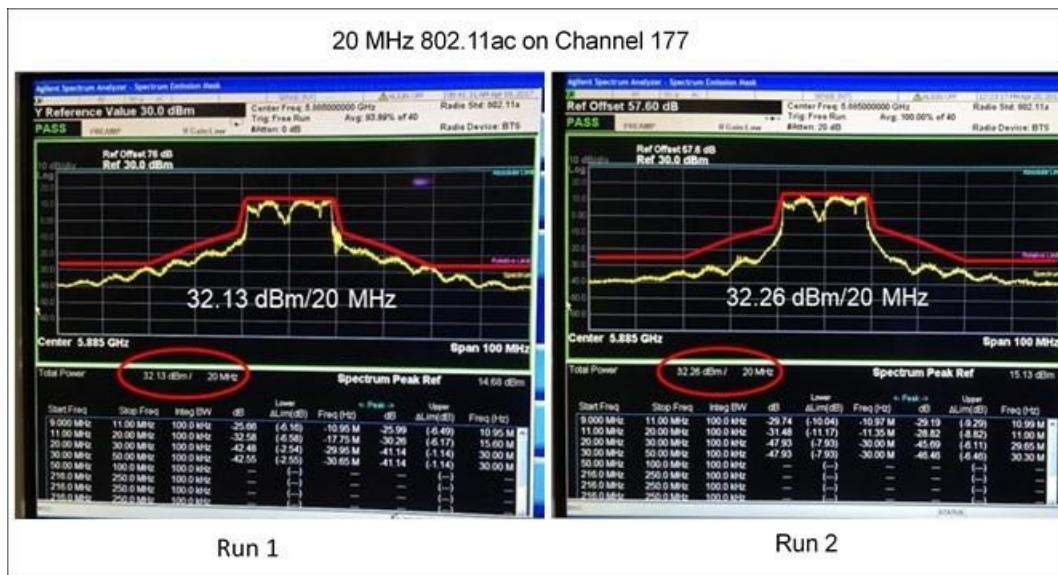

Source: Crash Avoidance Metrics Partners LLC (CAMP) Vehicle Safety Communications 6 (VSC6) Consortium

**Figure 8: 802.11ac Channel Power and Spectral Occupancy Measured for Channel 177 (20 MHz) – Run 1 versus Run 2**

A comparison of the Run 1 and Run 2 DSRC channel 180 results, which follow in Sections 4.3.1.1 and 4.3.1.2, illustrates the sensitivity to the 802.11ac spectral occupancy. Given that the Run 1 spectral occupancy (yellow curve - Figure 8, left side) is much closer to the limits defined by the spectral mask (red curve - Figure 8, left side), the results from this run may be more reflective of the potential levels of cross-channel interference caused by Wi-Fi and the impact to DSRC performance. The results from Run 2 show that reducing spectral occupancy as compared to the spectral mask defined in 802.11ac reduces the cross-channel interference impact to DSRC performance.

#### **4.3.1.1 DSRC on Channel 180 – Run 1 802.11ac 20 MHz Spectral Occupancy**

With the Run 1 Wi-Fi spectral occupancy for DSRC on channel 180, the results (Table 1) show DSRC performance degradation, with high packet errors (>10%), over almost the entire test range (testing was not done beyond 500 meters so the full range of cross-channel interference was not identified), except for a few data points where the PER dropped likely due to cancelling ground reflections of the 802.11ac AP. PER was higher (up to 91%) near the 802.11ac AP and decreased with distance, but was still observed at over 30% at 500 meters. The high PER is also reflected in the high IA results.

**Table 1: DSRC on Channel 180 – 802.11ac Channel 177/20 MHz (Run 1 Spectral Occupancy)**

DSRC Channel: 180 --- Wi-Fi Channel: 177 (20 MHz)												
Metric	Vehicle	Near Vehicle Range (m)										
		Far Vehicle Range (m)										
		0	25	50	75	100	125	150	175	200	225	250
		75	100	125	150	175	200	225	250	275	300	325
CBP (%)	Baseline	0										
	Near Vehicle	91	70	91	91	91	43	90	9	29	71	76
	Far Vehicle	91	91	54	91	8	41	71	74	41	27	18
PER (%)	Baseline	0										
	Near Vehicle	41	76	44	63	55	43	52	15	56	60	59
	Far Vehicle	97	31	49	77	38	11	49	51	49	42	41
Mean IA (ms)	Baseline	103										
	Near Vehicle	170	468	353	283	371	186	424	120	230	528	260
	Far Vehicle	2983	153	194	487	165	228	199	272	209	165	161
IA Std.Dev. (ms)	Baseline	17										
	Near Vehicle	104	405	166	229	440	131	221	47	177	338	224
	Far Vehicle	2595	93	131	468	100	63	134	279	164	92	89
RSSI (dBm)	Baseline	-68										
	Near Vehicle	-69	-69	-69	-70	-70	-70	-70	-70	-71	-71	-71
	Far Vehicle	-66	-68	-67	-69	-66	-68	-68	-69	-70	-69	-68

DSRC Channel: 180 --- Wi-Fi Channel: 177 (20 MHz)												
Metric	Vehicle	Near Vehicle Range (m)										
		Far Vehicle Range (m)										
		275	300	325	350	375	400	425	450	475	500	525
		350	375	400	425	450	475	500	525	550	575	
CBP (%)	Baseline	0										
	Near Vehicle	44	11	2	0	0	1	1	2	2	2	
	Far Vehicle	8	7	3	2	1	1	1	1	1	1	
PER (%)	Baseline	0										
	Near Vehicle	58	94	60	51	42	19	18	4	7	33	
	Far Vehicle	18	39	52	0	0	0	27	57	41	39	
Mean IA (ms)	Baseline	103										
	Near Vehicle	652	2869	2202	1014	451	207	148	112	116	212	
	Far Vehicle	128	377	2937	102	101	101	381	1213	791	542	
IA Std.Dev. (ms)	Baseline	17										
	Near Vehicle	562	2094	2695	1477	609	317	143	57	51	218	
	Far Vehicle	63	582	5512	15	11	10	702	1689	1410	841	
RSSI (dBm)	Baseline	-68										
	Near Vehicle	-71	-70	-70	-70	-70	-70	-69	-70	-71	-69	
	Far Vehicle	-70	-69	-69	-69	-68	-69	-68	-69	-69	-68	

Source: Crash Avoidance Metrics Partners LLC (CAMP) Vehicle Safety Communications 6 (VSC6) Consortium

#### 4.3.1.2 DSRC on Channel 180 – Run 2 802.11ac 20 MHz Spectral Occupancy

With the Run 2 Wi-Fi spectral occupancy for DSRC on channel 180, the results (Table 2) show that the reduction in 802.11ac power in the adjacent channel resulted in little DSRC performance degradation, with PER being close to 0% over the entire range. However, CBP was high in some cases, which would have a greater impact on a higher density DSRC scenario (much more than only two vehicles) or in scenarios comprising weaker V2V DSRC links than those used in these tests. This test was ceased at 150/225 meters (near/far vehicle) because little to no packet errors were being observed.

**Table 2: DSRC on Channel 180 – 802.11ac Channel 177/20 MHz (Run 2 Spectral Occupancy)**

DSRC Channel: 180 --- Wi-Fi Channel: 177 (20 MHz)								
Metric	Vehicle	Near Vehicle Range (m)				Far Vehicle Range (m)		
		0	25	50	75	100	125	150
		75	100	125	150	175	200	225
CBP (%)	Baseline	0						
	Near Vehicle	1	89	57	14	1	5	0
	Far Vehicle	46	7	19	0	0	1	1
PER (%)	Baseline	0						
	Near Vehicle	0	0	0	0	0	0	0
	Far Vehicle	0	2	1	0	0	0	0
Mean IA (ms)	Baseline	103						
	Near Vehicle	103	101	102	102	103	102	102
	Far Vehicle	101	103	103	101	101	101	102
IA Std.Dev. (ms)	Baseline	17						
	Near Vehicle	17	9	14	15	18	13	13
	Far Vehicle	12	16	17	11	10	9	13
RSSI (dBm)	Baseline	-68						
	Near Vehicle	-67	-69	-68	-71	-69	-68	-69
	Far Vehicle	-69	-66	-67	-69	-69	-67	-69

Source: Crash Avoidance Metrics Partners LLC (CAMP) Vehicle Safety Communications 6 (VSC6) Consortium

#### 4.3.1.3 DSRC on Channel 182 / 184 – Run 2 802.11ac 20 MHz Spectral Occupancy

With the Run 2 Wi-Fi spectral occupancy for DSRC on channel 182 (Table 3), a decrease in DSRC performance was observed, compared to DSRC on channel 180. High PER was observed up to 100 to 125 meters for the far vehicle, further indicating the sensitivity of DSRC performance to the 802.11ac spectral occupancy. For DSRC in channel 184 (Table 4), the cross-channel interference had little or no impact to DSRC performance.

**Table 3: DSRC on Channel 182 – 802.11ac Channel 177/20 MHz (Run 2 Spectral Occupancy)**

DSRC Channel: 182 --- Wi-Fi Channel: 177 (20 MHz)							
Metric	Vehicle	Near Vehicle Range (m) Far Vehicle Range (m)					
		0 75	25 100	50 125	75 150	100 175	125 200
CBP (%)	Baseline	0					
	Near Vehicle	0	5	1	0	0	0
	Far Vehicle	0	0	0	0	0	0
PER (%)	Baseline	0					
	Near Vehicle	0	0	0	0	0	0
	Far Vehicle	0	77	12	0	0	0
Mean IA (ms)	Baseline	103					
	Near Vehicle	101	101	102	101	100	101
	Far Vehicle	101	2362	139	102	103	102
IA Std.Dev. (ms)	Baseline	17					
	Near Vehicle	11	11	13	9	4	9
	Far Vehicle	11	2515	150	14	17	13
RSSI (dBm)	Baseline	-68					
	Near Vehicle	-70	-68	-70	-70	-70	-69
	Far Vehicle	-70	-69	-69	-70	-69	-69

Source: Crash Avoidance Metrics Partners LLC (CAMP) Vehicle Safety Communications 6 (VSC6) Consortium

**Table 4: DSRC on Channel 184 – 802.11ac Channel 177/20 MHz (Run 2 Spectral Occupancy)**

DSRC Channel: 184 --- Wi-Fi Channel: 177 (20 MHz)				
Metric	Vehicle	Near Vehicle Range (m) Far Vehicle Range (m)		
		0 75	25 100	50 125
CBP (%)	Baseline	0		
	Near Vehicle	0	0	0
	Far Vehicle	0	0	0
PER (%)	Baseline	0		
	Near Vehicle	0	0	0
	Far Vehicle	0	0	0
Mean IA (ms)	Baseline	103		
	Near Vehicle	101	102	102
	Far Vehicle	102	102	102
IA Std.Dev. (ms)	Baseline	17		
	Near Vehicle	12	13	12
	Far Vehicle	12	12	14
RSSI (dBm)	Baseline	-68		
	Near Vehicle	-67	-71	-71
	Far Vehicle	-66	-70	-70

Source: Crash Avoidance Metrics Partners LLC (CAMP) Vehicle Safety Communications 6 (VSC6) Consortium

### 4.3.2 DSRC with 40 MHz 802.11ac on Channel 175

The spectral occupancy achieved with 802.11ac on channel 175 (40 MHz) is shown in Figure 9. Ideally, to better understand the cross-channel interference potential, the test would have provided an

802.11ac spectral occupancy that was more consistently close to the mask allowed for 802.11ac devices (like Run 1 of the 20 MHz test), but given the difficulty of calibrating signal while staying within the defined mask, it was calibrated as closely as possible.

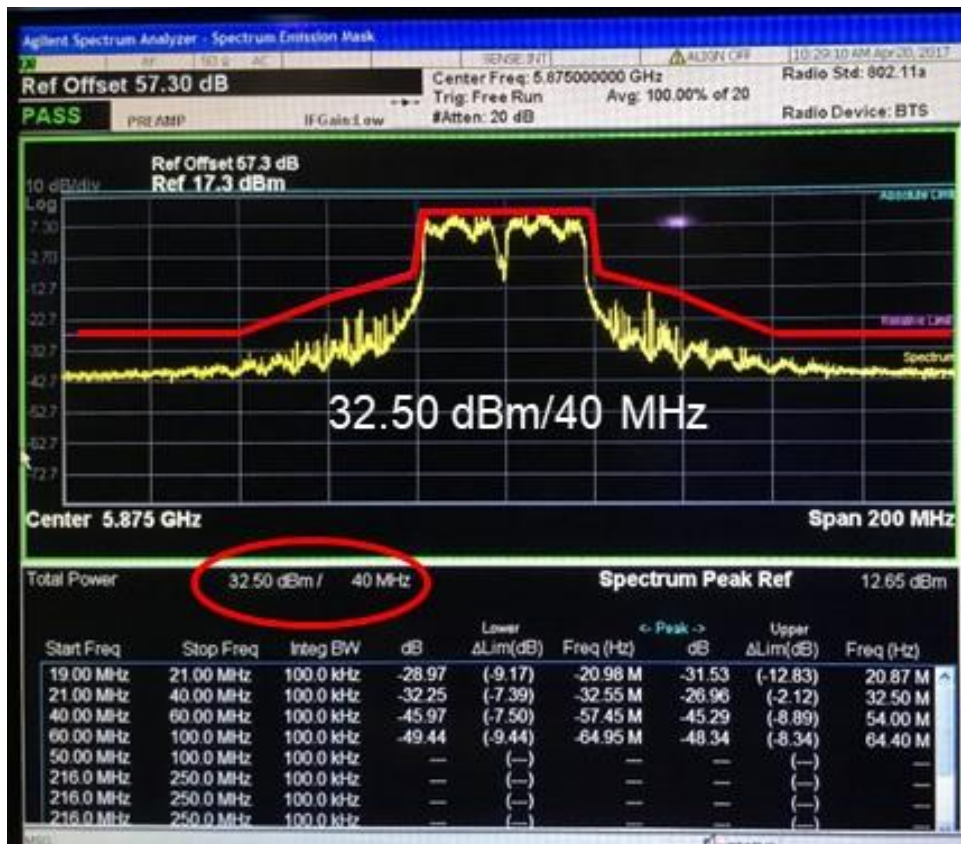

Source: Crash Avoidance Metrics Partners LLC (CAMP) Vehicle Safety Communications 6 (VSC6) Consortium

**Figure 9: 802.11ac Channel Power and Spectral Occupancy Measured for Channel 175 (40 MHz)**

The cross-channel interference test results for 802.11ac channel 175 (40 MHz) showed cross-channel interference causing an impact to DSRC performance up to a near / far vehicle range of 125 / 200 meters (Table 5 through Table 7) depending on the DSRC channel. At a near vehicle range of 0 meters, the PER is sometimes low and then increases at a 25-meter range. This is likely due to the near vehicle being under the “umbrella” of the 802.11ac AP antenna pattern. PER was higher for channels 182 and 184 than for 180, which experienced little to no cross-channel interference impact to DSRC performance. This observation is further indication of the sensitivity of DSRC to the 802.11ac spectral occupancy, including ripples or noise in the skirt in as shown in Figure 9.



Table 5: DSRC on Channel 180 – 802.11ac Channel 175/40 MHz

DSRC Channel: 180 --- Wi-Fi Channel: 175 (40 MHz)						
Metric	Vehicle	Near Vehicle Range (m)				
		Far Vehicle Range (m)				
		0 75	25 100	50 125	75 150	100 175
CBP (%)	Baseline	0				
	Near Vehicle	1	21	4	1	1
	Far Vehicle	1	1	5	0	1
PER (%)	Baseline	0				
	Near Vehicle	0	0	0	0	0
	Far Vehicle	0	3	0	0	0
Mean IA (ms)	Baseline	103				
	Near Vehicle	102	104	102	103	103
	Far Vehicle	101	105	102	102	101
IA Std.Dev. (ms)	Baseline	17				
	Near Vehicle	13	19	15	16	18
	Far Vehicle	12	22	13	14	9
RSSI (dBm)	Baseline	-68				
	Near Vehicle	-69	-70	-70	-70	-71
	Far Vehicle	-68	-68	-69	-70	-71

Source: Crash Avoidance Metrics Partners LLC (CAMP) Vehicle Safety Communications 6 (VSC6) Consortium

**Table 6: DSRC on Channel 182 – 802.11ac Channel 175/40 MHz**

DSRC Channel: 182 --- Wi-Fi Channel: 175 (40 MHz)											
Metric	Vehicle	Near Vehicle Range (m)									
		Far Vehicle Range (m)									
		0	25	50	75	100	125	150	175	200	225
		75	100	125	150	175	200	225	250	275	300
CBP (%)	Baseline	0									
	Near Vehicle	2	81	9	2	1	2	1	1	1	1
	Far Vehicle	1	1	2	0	1	1	1	1	1	1
PER (%)	Baseline	0									
	Near Vehicle	0	0	40	0	0	0	0	0	0	0
	Far Vehicle	37	58	64	17	0	15	0	0	0	0
Mean IA (ms)	Baseline	103									
	Near Vehicle	103	101	395	102	101	102	103	103	101	103
	Far Vehicle	480	457	1800	190	102	158	101	101	102	103
IA Std.Dev. (ms)	Baseline	17									
	Near Vehicle	16	8	548	15	12	14	16	16	8	18
	Far Vehicle	750	606	2210	282	13	190	10	7	13	17
RSSI (dBm)	Baseline	-68									
	Near Vehicle	-69	-68	-68	-69	-69	-68	-68	-68	-70	-70
	Far Vehicle	-68	-69	-69	-69	-69	-68	-67	-68	-70	-70

Source: Crash Avoidance Metrics Partners LLC (CAMP) Vehicle Safety Communications 6 (VSC6) Consortium

Table 7: DSRC on Channel 184 – 802.11ac Channel 175/40 MHz

DSRC Channel: 184 --- Wi-Fi Channel: 175 (40 MHz)								
Metric	Vehicle	Near Vehicle Range (m)						
		Far Vehicle Range (m)						
		0	25	50	75	100	125	150
		75	100	125	150	175	200	225
CBP (%)	Baseline	0						
	Near Vehicle	1	5	1	1	0	0	0
	Far Vehicle	1	0	1	0	0	0	0
PER (%)	Baseline	0						
	Near Vehicle	0	0	0	0	0	0	0
	Far Vehicle	0	54	0	0	0	0	0
Mean IA (ms)	Baseline	103						
	Near Vehicle	102	102	102	103	101	103	102
	Far Vehicle	102	1060	101	103	102	101	101
IA Std.Dev. (ms)	Baseline	17						
	Near Vehicle	12	12	13	17	11	16	15
	Far Vehicle	12	1499	10	18	13	9	7
RSSI (dBm)	Baseline	-68						
	Near Vehicle	-68	-69	-68	-70	-69	-69	-71
	Far Vehicle	-68	-70	-68	-70	-70	-69	-71

Source: Crash Avoidance Metrics Partners LLC (CAMP) Vehicle Safety Communications 6 (VSC6) Consortium

### 4.3.3 DSRC with 80 MHz 802.11ac on Channel 171

The spectral occupancy achieved with 802.11ac Wi-Fi on channel 171 (80 MHz) is shown in Figure 10. While the 802.11ac spectral occupancy was still not as close to the spectral mask allowed for 802.11ac devices as in Run 1 of the 20 MHz test, it appears to be closer to the mask than in Run 2 of the 20 MHz test or the 40 MHz test. The transmitted spectrum is noisy and has the same ripple effect as previous spectral occupancy measurements.

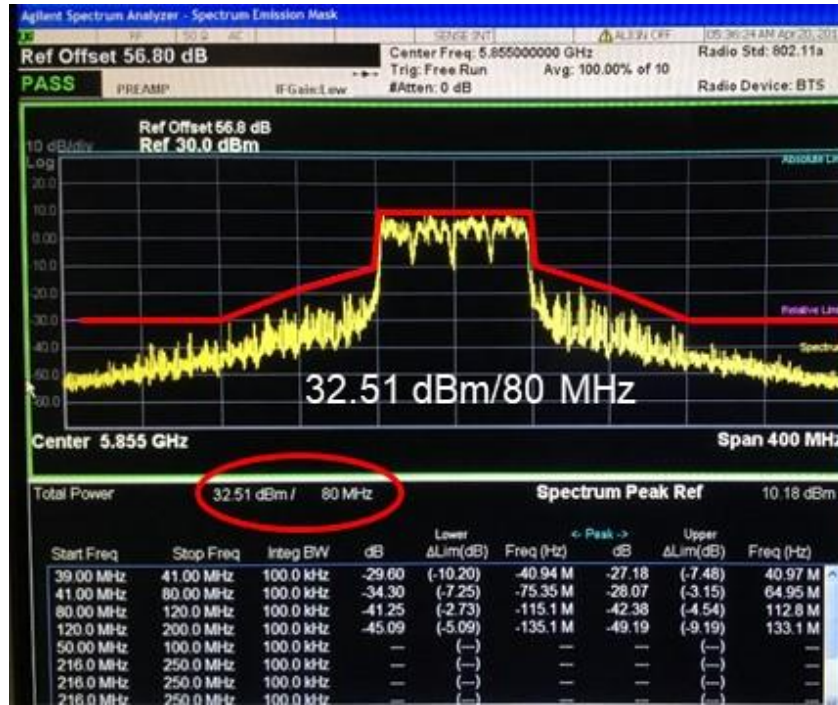

Source: Crash Avoidance Metrics Partners LLC (CAMP) Vehicle Safety Communications 6 (VSC6) Consortium

**Figure 10: 802.11ac Channel Power and Spectral Occupancy Measured for Channel 171 (80 MHz)**

The cross-channel interference test results for 802.11ac Wi-Fi on channel 171 (80 MHz) showed more cross-channel interference impact to DSRC performance than what was observed for the 40 MHz channel (Table 8 through Table 10). High PER and IA were observed up to 150 meters for the near vehicle and up to 300 meters for the far vehicle on all three DSRC channels. In addition to the increased spectral occupancy achieved for this test, the increase in cross-channel interference impact, as compared to the 20 MHz channel Run 2 spectral occupancy and 40 MHz channel spectral occupancy, can be attributed to the slower roll-off of the 802.11ac spectral occupancy for wider bandwidths (the tails of the spectral profile outside of the channel bandwidth do not decline as rapidly as narrower 802.11ac channel bandwidths). The “umbrella” effect of the 802.11ac AP antenna on the near vehicle was also observed for these tests. As well, for the far vehicle, the two-ray path loss cancelling effect appears to be occurring around 200 – 225 meters from the AP.

**Table 8: DSRC on Channel 180 – 802.11ac Channel 171/80 MHz**

DSRC Channel: 180 --- Wi-Fi Channel: 171 (80 MHz)														
Metric	Vehicle	Near Vehicle Range (m) Far Vehicle Range (m)												
		0	25	50	75	100	125	150	175	200	225	250	275	300
		75	100	125	150	175	200	225	250	275	300	325	350	375
CBP (%)	Baseline	0												
	Near Vehicle	6	12	5	3	2	3	0	1	2	2	1	0	0
	Far Vehicle	3	2	4	0	2	2	1	1	0	0	0	0	0
PER (%)	Baseline	0												
	Near Vehicle	0	37	3	0	18	21	23	17	0	0	0	0	0
	Far Vehicle	1	1	0	0	25	1	0	42	20	23	20	0	0
Mean IA (ms)	Baseline	103												
	Near Vehicle	100	363	104	101	211	230	375	143	102	101	100	101	101
	Far Vehicle	103	102	102	101	235	102	101	432	228	239	191	101	103
IA Std.Dev. (ms)	Baseline	17												
	Near Vehicle	3	553	22	9	333	333	839	113	15	12	6	11	11
	Far Vehicle	22	13	13	9	386	15	11	613	369	372	256	12	16
RSSI (dBm)	Baseline	-68												
	Near Vehicle	-69	-70	-70	-69	-71	-69	-70	-70	-70	-70	-70	-68	-69
	Far Vehicle	-67	-69	-68	-69	-69	-68	-68	-69	-69	-69	-70	-68	-68

Source: Crash Avoidance Metrics Partners LLC (CAMP) Vehicle Safety Communications 6 (VSC6) Consortium

**Table 9: DSRC on Channel 182 – 802.11ac Channel 171/80 MHz**

DSRC Channel: 182 --- Wi-Fi Channel: 171 (80 MHz)														
Metric	Vehicle	Near Vehicle Range (m)												
		Far Vehicle Range (m)												
		0	25	50	75	100	125	150	175	200	225	250	275	300
CBP (%)	Baseline	0												
	Near Vehicle	6	73	11	3	1	3	0	0	1	1	0	0	
	Far Vehicle	2	1	3	0	1	1	1	0	0	0	0	0	
PER (%)	Baseline	0												
	Near Vehicle	43	9	23	0	41	29	19	0	0	0	0	0	
	Far Vehicle	66	87	81	34	9	45	0	0	29	37	0	0	
Mean IA (ms)	Baseline	103												
	Near Vehicle	643	118	339	104	521	385	162	102	102	201	102	102	
	Far Vehicle	1975	2383	3169	495	134	488	103	104	254	301	103	102	
IA Std.Dev. (ms)	Baseline	17												
	Near Vehicle	1167	61	723	19	802	661	171	15	14	24	15	13	
	Far Vehicle	2827	2518	3257	956	136	653	16	19	346	404	16	14	
RSSI (dBm)	Baseline	-68												
	Near Vehicle	-70	-69	-70	-69	-70	-69	-68	-70	-70	-69	-69	-68	
	Far Vehicle	-68	-69	-68	-69	-69	-68	-68	-69	-69	-68	-69	-68	

Source: Crash Avoidance Metrics Partners LLC (CAMP) Vehicle Safety Communications 6 (VSC6) Consortium

**Table 10: DSRC on Channel 184 – 802.11ac Channel 171/80 MHz**

DSRC Channel: 184 --- Wi-Fi Channel: 171 (80 MHz)													
Metric	Vehicle	Near Vehicle Range (m) Far Vehicle Range (m)											
		0	25	50	75	100	125	150	175	200	225	250	275
		75	100	125	150	175	200	225	250	275	300	325	350
CBP (%)	Baseline	0											
	Near Vehicle	4	79	30	4	2	3	0	1	2	1	1	0
	Far Vehicle	2	1	3	0	1	1	1	0	0	0	0	0
PER (%)	Baseline	0											
	Near Vehicle	33	10	63	0	19	33	37	0	0	0	0	0
	Far Vehicle	56	80	75	24	38	28	0	26	40	24	0	0
Mean IA (ms)	Baseline	103											
	Near Vehicle	357	119	1282	102	179	289	359	101	102	101	101	102
	Far Vehicle	1485	2114	1312	280	320	344	102	278	439	248	102	101
IA Std.Dev. (ms)	Baseline	17											
	Near Vehicle	631	62	1540	13	216	437	556	10	15	12	9	12
	Far Vehicle	2043	3271	1596	442	438	616	14	446	740	386	13	12
RSSI (dBm)	Baseline	-68											
	Near Vehicle	-68	-68	-68	-69	-68	-68	-68	-68	-69	-69	-69	-67
	Far Vehicle	-65	-67	-66	-67	-66	-66	-66	-66	-66	-66	-67	-65

Source: Crash Avoidance Metrics Partners LLC (CAMP) Vehicle Safety Communications 6 (VSC6) Consortium

### 4.3.4 DSRC with 160 MHz 802.11ac on Channel 163

The spectral occupancy achieved with 802.11ac Wi-Fi on channel 163 (160 MHz) is shown in Figure 11. Like the 80 MHz test, the spectral occupancy appears to be closer to the mask than in Run 2 of the 20 MHz test or the 40 MHz test, although it was still not as close to the mask allowed for 802.11ac devices as in Run 1 of the 20 MHz test.

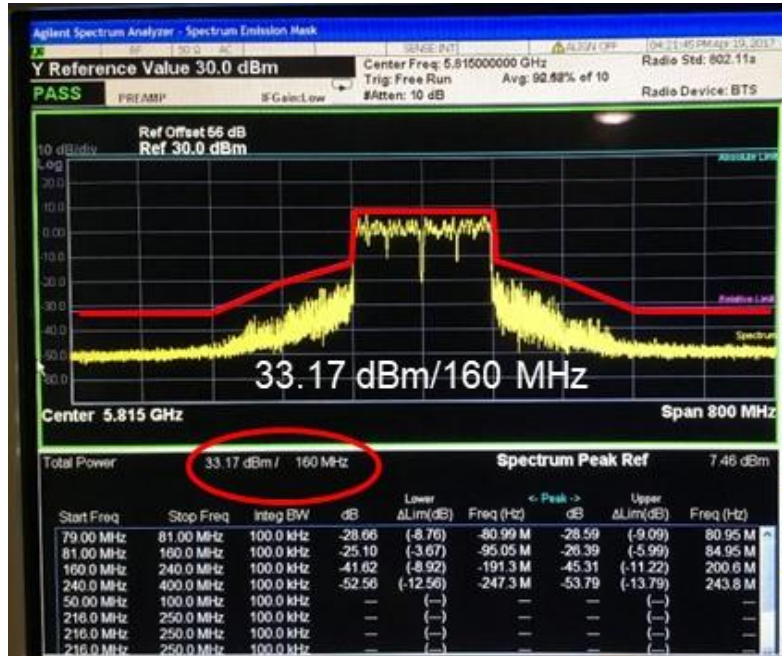

Source: Crash Avoidance Metrics Partners LLC (CAMP) Vehicle Safety Communications 6 (VSC6) Consortium

**Figure 11: 802.11ac Channel Power and Spectral Occupancy Measured for Channel 163 (160 MHz)**

Table 11 through Table 13 include the results of the 160 MHz channel tests. DSRC performance impact, with high PER and IA, was observed up to 75 meters for the near vehicle and up to 225 meters for the far vehicle on all three DSRC channels. According to these tests for the far vehicle, the two-ray path loss cancelling effect appears to be occurring around 200 meters from the AP.



**Table 11: DSRC on Channel 180 – 802.11ac Channel 163/160 MHz**

DSRC Channel: 180 --- Wi-Fi Channel: 163 (160 MHz)												
Metric	Vehicle	Near Vehicle Range (m)										
		Far Vehicle Range (m)										
		0	25	50	75	100	125	150	175	200	225	250
		75	100	125	150	175	200	225	250	275	300	325
CBP (%)	Baseline	0										
	Near Vehicle	8	2	3	4	4	0	2	0	0	0	1
	Far Vehicle	4	4	0	2	0	0	0	1	0	0	0
PER (%)	Baseline	0										
	Near Vehicle	53	43	0	57	0	0	2	0	0	0	0
	Far Vehicle	0	66	14	28	33	0	50	0	0	1	0
Mean IA (ms)	Baseline	103										
	Near Vehicle	1228	713	101	2212	102	101	105	102	102	102	101
	Far Vehicle	102	2881	121	237	410	102	845	102	102	102	102
IA Std.Dev. (ms)	Baseline	17										
	Near Vehicle	1840	1287	7	3438	12	9	32	14	12	14	12
	Far Vehicle	15	4041	59	346	699	13	1509	13	14	17	14
RSSI (dBm)	Baseline	-68										
	Near Vehicle	-69	-70	-69	-70	-70	-69	-70	-70	-70	-70	-69
	Far Vehicle	-67	-69	-68	-69	-69	-68	-69	-68	-69	-69	-69

Source: Crash Avoidance Metrics Partners LLC (CAMP) Vehicle Safety Communications 6 (VSC6) Consortium

**Table 12: DSRC on Channel 182 – 802.11ac Channel 163/160 MHz**

DSRC Channel: 182 --- Wi-Fi Channel: 163 (160 MHz)												
Metric	Vehicle	Near Vehicle Range (m)										
		Far Vehicle Range (m)										
		0	25	50	75	100	125	150	175	200	225	250
		75	100	125	150	175	200	225	250	275	300	325
CBP (%)	Baseline	0										
	Near Vehicle	16	2	8	7	7	0	2	0	0	0	1
	Far Vehicle	6	7	0	2	0	0	0	0	0	0	0
PER (%)	Baseline	0										
	Near Vehicle	79	70	0	64	0	0	0	0	0	0	0
	Far Vehicle	79	72	73	64	47	0	68	0	0	3	0
Mean IA (ms)	Baseline	103										
	Near Vehicle	3739	2087	103	1967	102	101	102	101	102	102	103
	Far Vehicle	2579	3621	2351	1618	1177	101	3497	102	103	104	101
IA Std.Dev. (ms)	Baseline	17										
	Near Vehicle	4260	3050	16	2639	15	11	15	10	13	13	18
	Far Vehicle	2753	3841	2587	2268	2106	10	5061	15	17	22	9
RSSI (dBm)	Baseline	-68										
	Near Vehicle	-68	-69	-68	-69	-69	-67	-68	-68	-69	-68	-68
	Far Vehicle	-67	-67	-67	-68	-68	-67	-66	-66	-68	-68	-68

Source: Crash Avoidance Metrics Partners LLC (CAMP) Vehicle Safety Communications 6 (VSC6) Consortium

**Table 13: DSRC on Channel 184 – 802.11ac Channel 163/160 MHz**

DSRC Channel: 184 --- Wi-Fi Channel: 163 (160 MHz)											
Metric	Vehicle	Near Vehicle Range (m)									
		Far Vehicle Range (m)									
		0	25	50	75	100	125	150	175	200	225
		75	100	125	150	175	200	225	250	275	300
CBP (%)	Baseline	0									
	Near Vehicle	23	2	6	6	6	0	2	0	0	1
	Far Vehicle	5	4	0	2	0	0	0	0	0	0
PER (%)	Baseline	0									
	Near Vehicle	72	55	0	61	0	0	0	0	0	0
	Far Vehicle	75	60	46	49	51	0	50	0	0	0
Mean IA (ms)	Baseline	103									
	Near Vehicle	2338	1761	102	1673	104	103	103	103	102	102
	Far Vehicle	2452	1573	948	1119	833	101	951	101	101	101
IA Std.Dev. (ms)	Baseline	17									
	Near Vehicle	2600	2740	16	2273	18	18	16	16	13	13
	Far Vehicle	3610	2052	1671	1776	1241	10	1735	10	8	10
RSSI (dBm)	Baseline	-68									
	Near Vehicle	-67	-69	-68	-68	-68	-68	-68	-69	-69	-69
	Far Vehicle	-64	-66	-65	-66	-66	-65	-65	-66	-66	-67

Source: Crash Avoidance Metrics Partners LLC (CAMP) Vehicle Safety Communications 6 (VSC6) Consortium

## 4.4 Different DSRC Radio Model Test Results

The tests results presented in Section 4.3 were based on a test configuration that used a DSRC device with a radio compliant with the SAE J2945/1 specified standard adjacent and non-adjacent channel rejection (ACR / nACR) requirements. Just prior to the testing, a different DSRC device with a radio reported to have improved ACR / nACR requirements was acquired. These DSRC devices will herein be referred to as Radio 1 and Radio 2, respectively. So, in addition, a preliminary single cross-channel test, with 802.11ac on channel 163/160 MHz, was conducted for Radio 2 (supported the improved ACR / nACR requirements) for comparison purposes with Radio 1 (supported the standard ACR / nACR requirements).

Due to time constraints, only one DSRC channel / 802.11ac channel combination could be tested. The 802.11ac channel and bandwidth was 163/160 MHz with DSRC in channel 180. This combination was selected because it is believed to represent the worst-case scenario for potential cross-channel interference (i.e., adjacent-channel for this test) to DSRC from 802.11ac Wi-Fi. Given that this test was run on a different day, there was a different spectral occupancy for the 160 MHz 802.11ac signal than previously discussed (see Section 4.3.4) as shown in Figure 12.

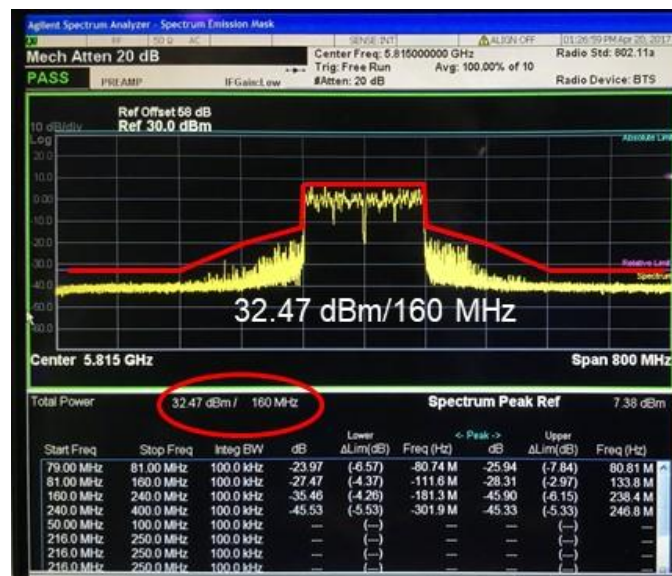

Source: Crash Avoidance Metrics Partners LLC (CAMP) Vehicle Safety Communications 6 (VSC6) Consortium

**Figure 12: 802.11ac Channel Power and Spectral Occupancy Measured for Channel 163 (160 MHz) – Different Radio Model Test**

The Radio 1 results are shown in Table 14 with high PER and IA up to a range of 150 meters for the near vehicle and 300 meters for the far vehicle. Note that the cross-channel interference range, and thus impact to DSRC performance, for this test was further than for the results presented in Table 11 for the same DSRC / 802.11ac channel combination. This is likely due to the increased spectral occupancy of the 802.11ac signal compared to the previous test. The Radio 2 results are shown in Table 15. Its DSRC performance was less impacted, with noticeable PER up to only 75 meters, but still lower than Radio 1.

Since this hardware was new to the Team, no RF characterization had been performed to quantify the level of improved ACR and nACR performance. For example, regarding cross-channel receive rejection, does Radio 2 meet the enhanced ACR and nACR requirements of IEEE 802.11, and, if so,

does it exceed the requirements? Therefore, these results should be considered preliminary. Prior to any future field testing, controlled cabled lab tests will need to be performed to characterize receiver and potentially other RF performance of Radio 1 and Radio 2. This will aid in a better understanding of the potential benefits that may be achieved with improved ACR / nACR capabilities. It should be noted that SAE J2945/1 requires the standard ACR and nACR as a minimum requirement. Requiring enhanced ACR would require a change to the J2945/1 Standard. Furthermore, even though these tests are focused on V2V, this is not the only intended application of DSRC. The possibility exists for aftermarket, personal, and other DSRC devices to be deployed in which the enhanced parameters may not be achievable. So, the impact of cross-channel interference with standard ACR / nACR may still be a concern for these devices and any cross-channel interference assessment and corresponding action may still need to be based on the results for devices with standard ACR / nACR.

**Table 14: DSRC on Channel 180 – 802.11ac Channel 163/160 MHz: DSRC Radio 1**

DSRC Channel: 180 --- Wi-Fi Channel: 163 (160 MHz)													
Metric	Vehicle	Near Vehicle Range (m) Far Vehicle Range (m)											
		0	25	50	75	100	125	150	175	200	225	250	275
		75	100	125	150	175	200	225	250	275	300	325	350
CBP (%)	Baseline	0											
	Near Vehicle	4	10	8	6	3	6	0	1	2	2	1	0
	Far Vehicle	7	3	8	0	3	4	3	2	0	0	0	0
PER (%)	Baseline	0											
	Near Vehicle	53	75	11	0	70	68	70	74	0	0	0	0
	Far Vehicle	61	2	0	56	69	51	0	51	61	54	1	0
Mean IA (ms)	Baseline	103											
	Near Vehicle	812	10232	128	104	2161	2318	3961	1644	101	102	102	101
	Far Vehicle	1729	103	102	1444	3063	1641	104	679	1528	1589	103	101
IA Std.Dev. (ms)	Baseline	17											
	Near Vehicle	1166	13600	104	19	2757	3107	6257	1722	12	13	13	11
	Far Vehicle	2547	18	15	2019	3662	2859	19	1000	2228	2793	19	10
RSSI (dBm)	Baseline	-68											
	Near Vehicle	-68	-69	-68	-68	-70	-69	-69	-69	-69	-70	-70	-69
	Far Vehicle	-68	-68	-67	-68	-69	-68	-68	-67	-69	-69	-69	-68

Source: Crash Avoidance Metrics Partners LLC (CAMP) Vehicle Safety Communications 6 (VSC6) Consortium

**Table 15: DSRC on Channel 180 – 802.11ac Channel 163/160 MHz: DSRC Radio 2**

DSRC Channel: 180 --- Wi-Fi Channel: 163 (160 MHz)										
Metric	Vehicle	Near Vehicle Range (m) Far Vehicle Range (m)								
		0 75	25 100	50 125	75 150	100 175	125 200	150 225	175 250	50 250
CBP (%)	Baseline	0								
	Near Vehicle	4	8	8	7	5	6	0	0	7
	Far Vehicle	4	0	7	1	1	1	0	0	0
PER (%)	Baseline	0								
	Near Vehicle	0	0	0	0	0	0	0	0	0
	Far Vehicle	8	0	0	0	0	0	0	0	0
Mean IA (ms)	Baseline	103								
	Near Vehicle	100	100	100	100	100	100	100	100	100
	Far Vehicle	110	100	100	100	100	100	100	100	100
IA Std.Dev. (ms)	Baseline	17								
	Near Vehicle	4	3	5	0	5	0	3	0	0
	Far Vehicle	35	4	5	0	6	3	0	3	4
RSSI (dBm)	Baseline	-68								
	Near Vehicle	-63	-62	-62	-63	-65	-64	-63	-64	-70
	Far Vehicle	-63	-62	-62	-63	-64	-63	-63	-64	-69

Source: Crash Avoidance Metrics Partners LLC (CAMP) Vehicle Safety Communications 6 (VSC6) Consortium

## 5 Observations and Next Steps

### 5.1 Summary Observations

This report focused on cross-channel testing which involved characterizing the baseline cross-channel interference impact to DSRC performance on channels 180, 182 and 184 from 802.11ac in the lower 45 MHz of the DSRC band. A higher-power solution was procured that enabled testing of the maximum proposed EIRP for U-NII-4 devices as it represents a use-case similar to the high-power APs being installed by cable companies in the U-NII-3 band. All these tests left the baseline DSRC V2V distance of 75 meters unmodified which substantiates comparison of cross-channel interference scenarios to the baseline DSRC scenarios. While it is recognized that this led to stronger DSRC RSS levels than would be experienced at longer ranges or in NLOS environments, a primary purpose of the testing was a first characterization of the potential cross-channel interference range of 802.11ac devices to DSRC performance. Also, the focus of the testing was on interference and did not attempt to model various network traffic patterns of wireless LANs.

Cross-channel test results showed the potential for cross-channel interference, having an impact on DSRC performance, up to a range of 500 meters or more, but typically between 200 and 300 meters. However, the results also generally showed that the closer the spectral occupancy was to the 802.11ac spectral mask requirements, the greater the cross-channel interference impact to DSRC performance. Not all the tests were able to achieve a spectral occupancy close to the mask spectral requirements.

When testing a different DSRC radio (Radio 2) with improved cross-channel receive rejection (ACR / nACR) characteristics, the cross-channel interference range was shorter for the one test run. However, these results should be considered preliminary pending controlled lab tests to characterize the receiver and potentially other RF performance of the radios along with additional field testing. It should be noted that SAE J2945/1 requires the standard ACR and nACR as a minimum requirement. Requiring enhanced ACR would require a change to that Standard. Also, the possibility exists for aftermarket, personal, and other DSRC devices to be deployed in which the enhanced parameters may not be achievable.

### 5.2 Next Steps

Future testing will include more detailed mechanisms for characterizing coexistence such as:

- Characterizing in detail the performance of DSRC radios with higher performance receivers
- Verifying with a signal analyzer whether the noted duty cycle decrease from the 160 MHz carrier is due to packet aggregation
- Acquiring variable attenuators to enable better control / repeatability in obtaining the desired spectral occupancy
- Gaining access to broader range of 802.11ac settings for deeper analysis (e.g., modulation/rate control and packet aggregation thresholds)
- Testing with various 802.11ac traffic patterns, e.g.:
  - Lower data rates (CBP), such as 3 and 30 Mbps data streams
  - Streaming video applications
  - LAN traffic simulator



- More clients
- Testing at more realistic DSRC link RSS values which are more representative of DSRC's required performance capabilities

## 6 References

- [1] Federal Communications Commission, “*In the Matter of Revision of Part 15 of the Commission’s Rules to Permit Unlicensed National Information Infrastructure (U-NII) Devices in the 5 GHz Band*,” ET Docket No. 13-49, February 20, 2013.
- [2] Federal Communications Commission, “Report and Order,” FCC 03-324, Adopted December 17, 2003. ([https://apps.fcc.gov/edocs\\_public/attachmatch/FCC-03-324A1.pdf](https://apps.fcc.gov/edocs_public/attachmatch/FCC-03-324A1.pdf))
- [3] Federal Communications Commission, “*The Commission Seeks to Update and Refresh the Record in the “Unlicensed National Information Infrastructure (U-NII) Devices in the 5 GHz Band” Proceeding*”, Public Notice 16-68, ET Docket No. 13-49, June 1, 2016. (<https://ecfsapi.fcc.gov/file/60002090296.pdf>)
- [4] SAE International®, “*Surface Vehicle Standard – Dedicated Short Range Communications (DSRC) Message Set Dictionary*,” SAE J2735, Revised 2009-11.SAE J2945/1 March 2016.
- [5] SAE International®, “*Surface Vehicle Standard – On-Board System Requirements for V2V Safety Communications*,” J2945™/1, Issued 2016-03.
- [6] IEEE Computer Society, “*IEEE Standard for Information technology — Telecommunications and information exchange between systems — Local and metropolitan area networks — Specific requirements, Part 11: Wireless LAN Medium Access Control (MAC) and Physical Layer (PHY) Specifications, Amendment 6: Wireless Access in Vehicular Environments*,” IEEE Std 802.11p™-2010.
- [7] IEEE Computer Society, “*IEEE Standard for Information technology — Telecommunications and information exchange between systems — Local and metropolitan area networks — Specific requirements, Part 11: Wireless LAN Medium Access Control (MAC) and Physical Layer (PHY) Specifications, Amendment 4: Enhancements for Very High Throughput for Operation in Bands below 6 GHz*,” IEEE Std 802.11ac™-2013.

## APPENDIX A. List of Acronyms

ACR	Adjacent Channel Rejection
AIFSN	Arbitration Interframe Space Number
AP	Access Point
ASTM	American Society for Testing and Materials
BDA	Bi-directional Amplifier
BSM	Basic Safety Message
CAMP LLC	Crash Avoidance Metrics Partners LLC
CBP	Channel Busy Percentage
CWmin	Contention Window (minimum)
DAC	Driver Acceptance Clinic
DSRC	Dedicated Short Range Communications
EDCA	Enhanced Distributed Channel Access
EIRP	Effective Isotropic Radiated Power
FCC	Federal Communications Commission
GPS	Global Positioning System
IA	Information Age
IEEE	Institute of Electrical and Electronics Engineers
ILV	Integrated Light Vehicle
IP	Internet Protocol
LAN	Local Area Network
LTE	Long-Term Evolution
MAC	Medium Access Control
nACR	Non-Adjacent Channel Rejection
NHTSA	National Highway Traffic Safety Administration

NLOS	Non-Line-of-Sight
NPRM	Notice of Proposed Rulemaking
NTIA	National Telecommunications and Information Administration
OBE	On-board Equipment
PER	Packet Error Ratio
PHY	Physical Layer
PSD	Power Spectral Density
RF	Radio Frequency
RSS	Received Signal Strength
SAE	Society of Automotive Engineers International
U-NII	Unlicensed National Information Infrastructure
USDOT	United States Department of Transportation
V2I	Vehicle-to-Infrastructure
V2V	Vehicle-to-Vehicle
V2V-CR	Vehicle-to-Vehicle Communications Research (Project)
VSC6	Vehicle Safety Communications 6 (Consortium)

## APPENDIX B. DSRC and 802.11ac Device Settings

Table 16: DSRC Unit Settings

Parameter	Setting
Transmit Power	Approximately 17 dBm (conducted into antenna)
Data Traffic Payload Size	Approximately 200 to 300 bytes
Data Traffic Protocol	WSMP
EDCA Parameters <sup>6</sup>	AC_VI (per J2945/1 [5]) <ul style="list-style-type: none"> <li>• CWmin = 15</li> <li>• AIFSN = 4</li> </ul>
Transmit Queue Depth <sup>7</sup>	1
CCA Energy Detection Threshold (non-DSRC signals)	Approximately -81 dBm
Congestion Control	Off

Source: Crash Avoidance Metrics Partners LLC (CAMP) Vehicle Safety Communications 6 (VSC6) Consortium

Table 17: 802.11ac Device Settings

Parameter	Setting
Transmit Power	Approximately 36 dBm EIRP
Data Traffic Payload Size	1400 bytes
Data Traffic Protocol	UDP/IP
EDCA Parameters	AC_BE (Best Effort), 802.11ac default <ul style="list-style-type: none"> <li>• CWmin = 15</li> <li>• CWmax = 1023</li> <li>• AIFSN = 3</li> </ul>
CCA Energy Detection Threshold	Approximately -65 dBm

Source: Crash Avoidance Metrics Partners LLC (CAMP) Vehicle Safety Communications 6 (VSC6) Consortium

<sup>6</sup> Because the DSRC traffic is broadcast, CWmax is not relevant to DSRC transmissions (there can be no attempt at retransmission after the initial broadcast transmission because broadcast packets are not acknowledged by a receiver)

<sup>7</sup> The transmit queue depth is generally set to 1 in V2V systems for sending BSMs so that if a newer BSM arrives at the queue before the previous BSM can be transmitted, the previous BSM is discarded and the newer BSM placed in the queue.

# APPENDIX C. RF Terms and Definitions

Following are some of the terms and their definitions that are used to describe the cross-channel interference results presented in this report:

- Spectral Mask:** Transmission limits that define maximum power permitted outside the channel bandwidth, relative to power within the channel bandwidth

The specified units are dB<sub>r</sub>, the amount of which is the reduction of signal power in dB relative to power within the channel bandwidth. Spectral masks for 802.11ac are defined for 20, 40, 80 and 160 MHz channel bandwidths by specifying relative power limits at offsets from the center frequency of the channel as shown in Figure 13, where the offsets for the channel bandwidth are shown in the table following the mask plot.

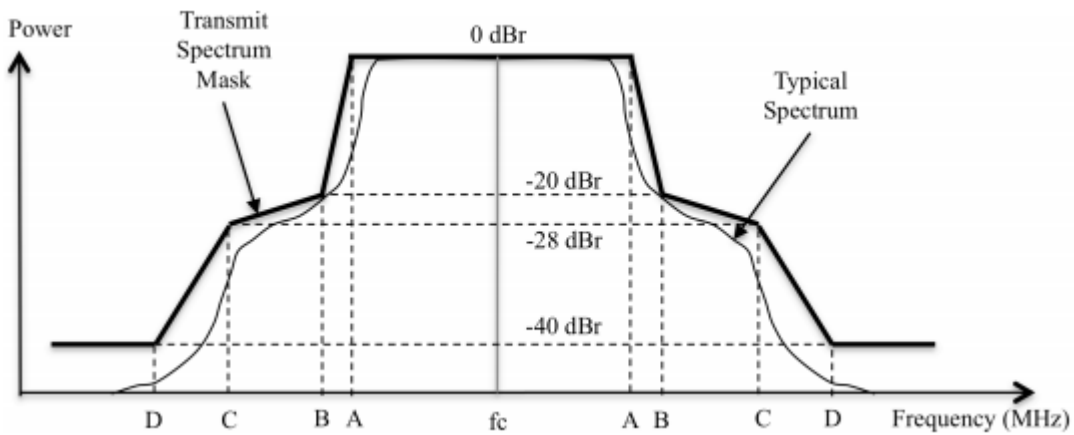

Signal Bandwidth	Offset A	Offset B	Offset C	Offset D
20 MHz	± 9 MHz	± 11 MHz	± 20 MHz	± 30 MHz
40 MHz	± 19 MHz	± 21 MHz	± 40 MHz	± 60 MHz
80 MHz	± 39 MHz	± 41 MHz	± 80 MHz	± 120 MHz
160 MHz	± 79 MHz	± 81 MHz	± 160 MHz	± 240 MHz

Source: National Instruments™, “Introduction to Wireless LAN Measurements From 802.11a to 802.1ac”

**Figure 13: Transmit Spectral Mask for 802.11ac**

The spectral mask is intended to reduce cross-channel interference by limiting emissions outside of the channel bandwidth. As the difference between power permitted within the channel bandwidth and power permitted outside the channel band increases, the potential for cross-channel interference decreases.

- Power Spectral Density (PSD):** The distribution of power over frequency for a radio transmission

PSD is typically measured over many narrow slices of spectrum across a frequency band. The width of each slice is referred to as the “resolution bandwidth” (a setting available on spectrum analyzers used to verify compliance with spectral masks). To accurately measure PSD, it is desirable to use a resolution bandwidth that is significantly narrower than the channel bandwidth. For 802.11ac, the resolution bandwidth required for testing compliance

with spectral masks is 100 kHz, which is at least two orders of magnitude narrower than the various 802.11ac channel bandwidths.

- **Conducted Transmit Power:** The total power within the channel bandwidth of the transmitted signal, which is measured at the antenna connector of the radio

The conducted transmit power is limited to levels defined by standards and FCC rules (conducted transmit power is often permitted to be adjusted to compensate for cable loss between the radio antenna connector and the antenna). Power is ultimately limited in standards and FCC rules by the maximum EIRP.

Compliance with 802.11ac spectral masks is required regardless of the conducted transmit power. However, as conducted transmit power increases it usually becomes more difficult to comply with spectral masks.

- **EIRP:** A characterization of radiated power, which is computed in dBm as the conducted transmit power in dBm (minus cable loss between the radio and antenna in dB) plus antenna gain in dBi (The gain parameter of an antenna in dBi is specified based on the direction from the antenna at which the most gain occurs.)
- **Spectral Occupancy:** The PSD of a radio transmission relative to the spectral mask

The closer the PSD is to the spectral mask, the higher the spectral occupancy and thus the greater the potential for cross-channel interference. The potential for cross-channel interference further increases as the radiated power increases. A compliant spectral occupancy represents the case when the PSD of the radio transmission is always below the spectral mask. In the proposed U-NII-4 rules, radiated power would be limited by a maximum of 36 dBm EIRP.

U.S. Department of Transportation  
ITS Joint Program Office-HOIT  
1200 New Jersey Avenue, SE  
Washington, DC 20590

Toll-Free "Help Line" 866-367-7487  
[www.its.dot.gov](http://www.its.dot.gov)

**Pre-Final Version - NHTSA-JPO-XX-XXX**



U.S. Department of Transportation