

VIN marking area for MY20 Sonata

1. Hood
2. Tailgate
3. Front Fender (LH/RH)
4. Front Door (LH/RH)
5. Rear Door (LH/RH)
6. Side Outer Panel (LH/RH)
7. Front Bumper
8. Rear Bumper
9. Engine (1.6/2.5L)
10. Transmission



Hood

TARGET AREA FOR
ORIGINALLY EQUIPPED PART

TARGET AREA FOR
REPLACEMENT PART

RH

LH

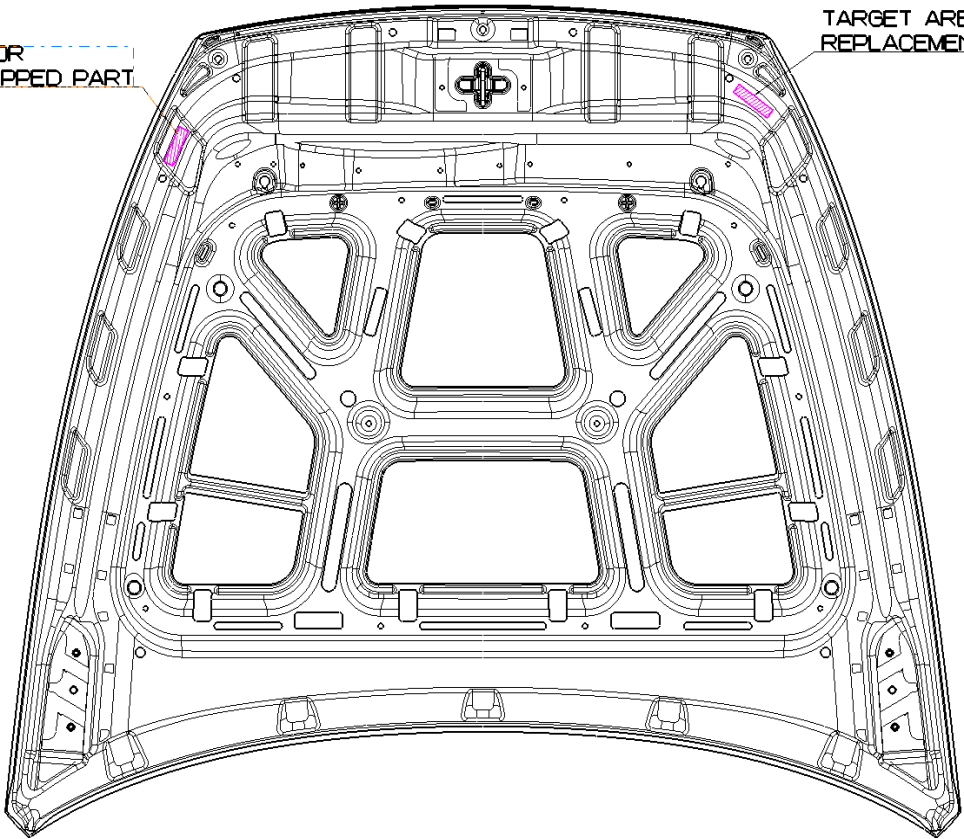

Tailgate

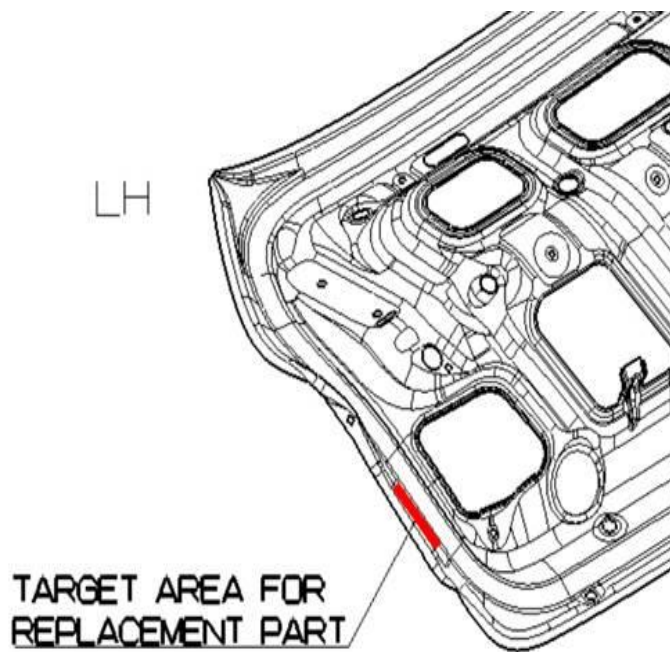
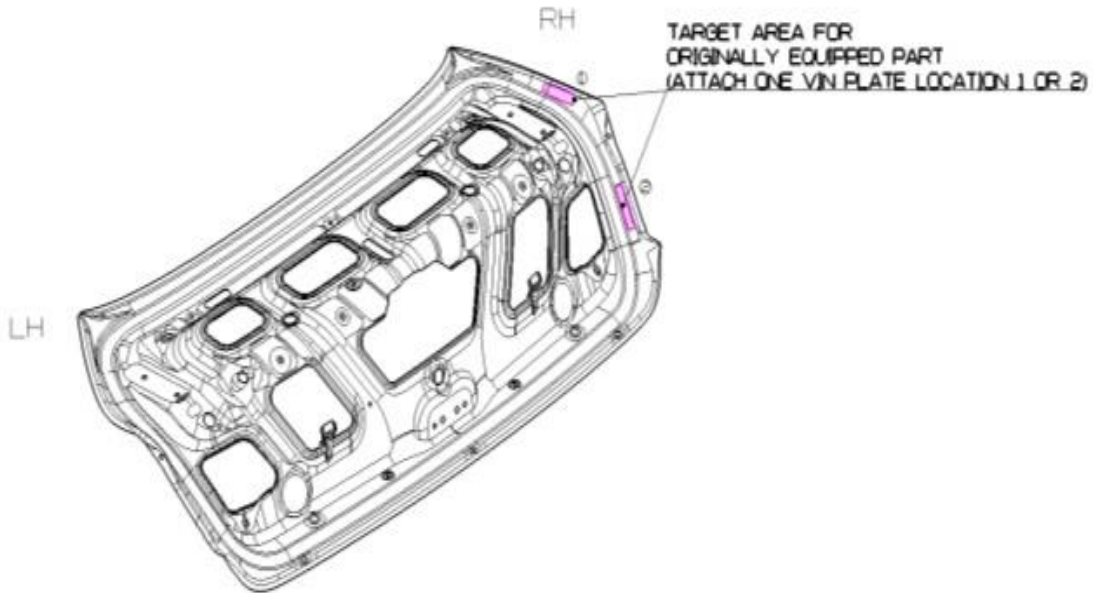

Front Fender (LH/RH)

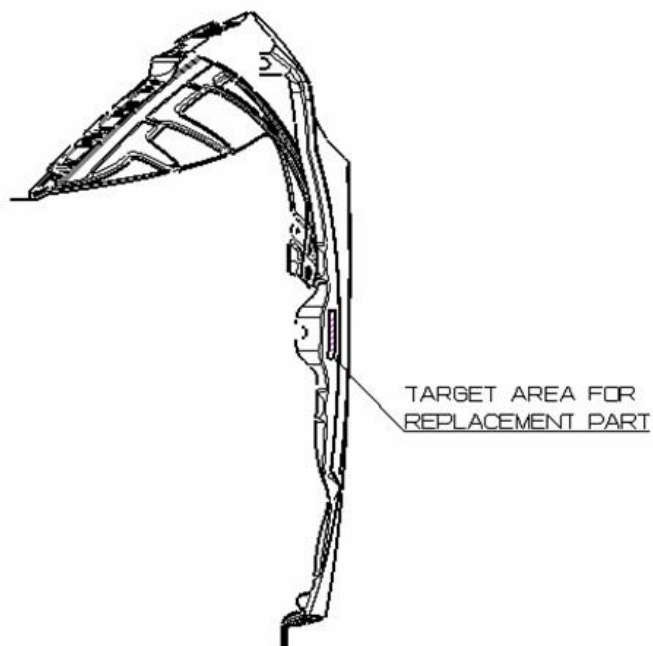
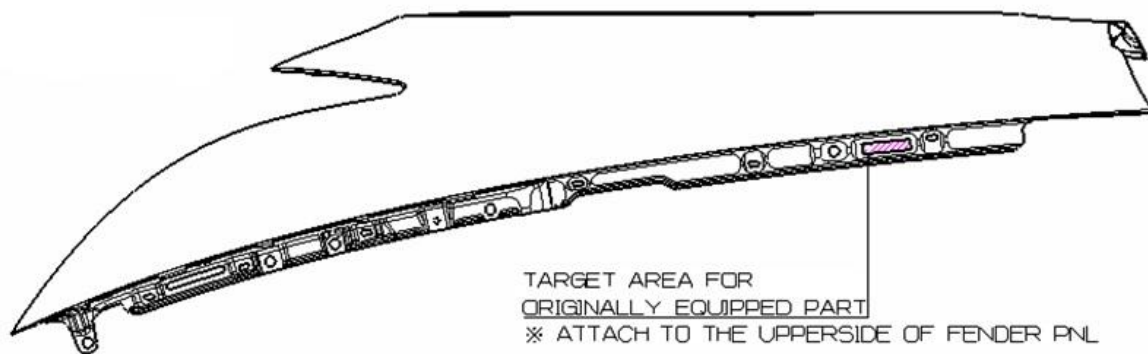

Front Door (LH/RH)

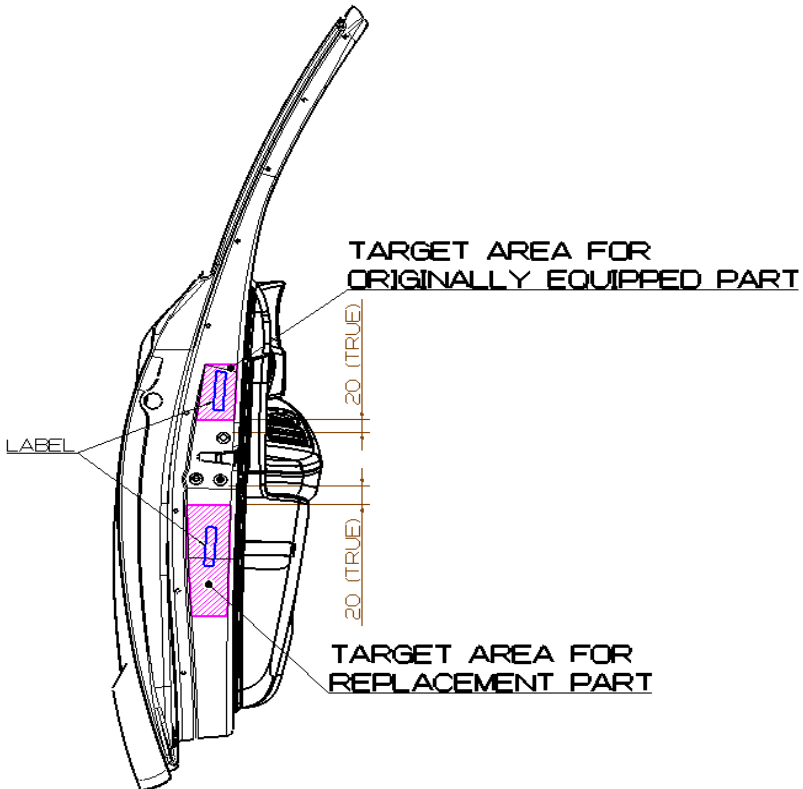
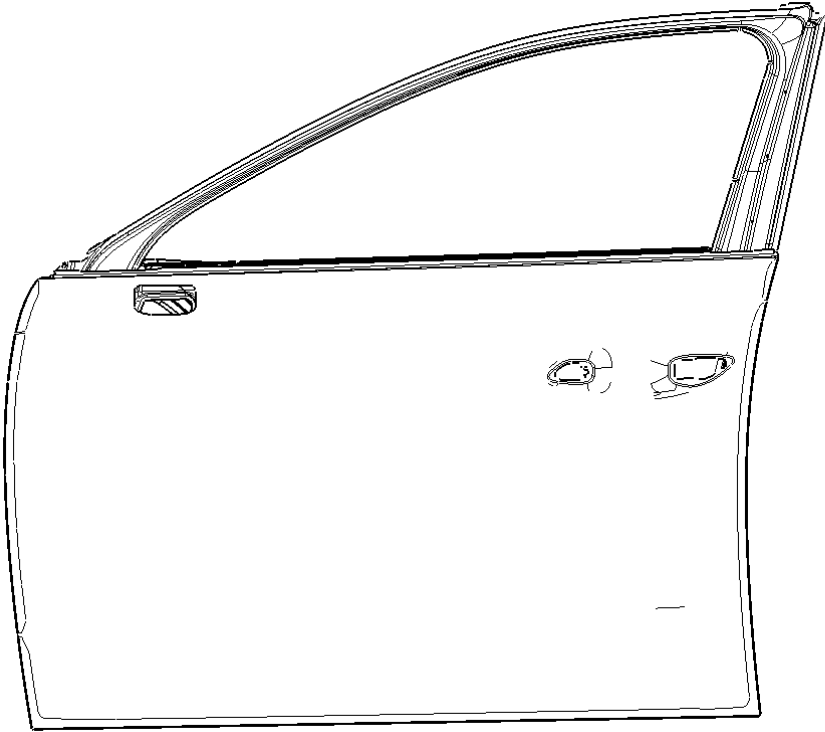

Rear Door (LH/RH)

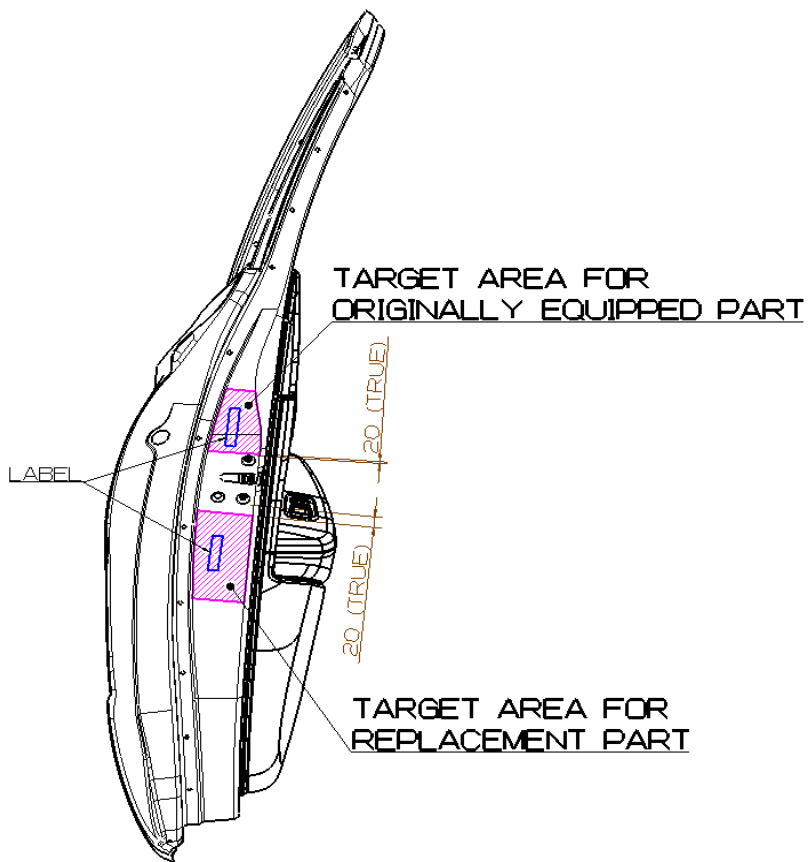
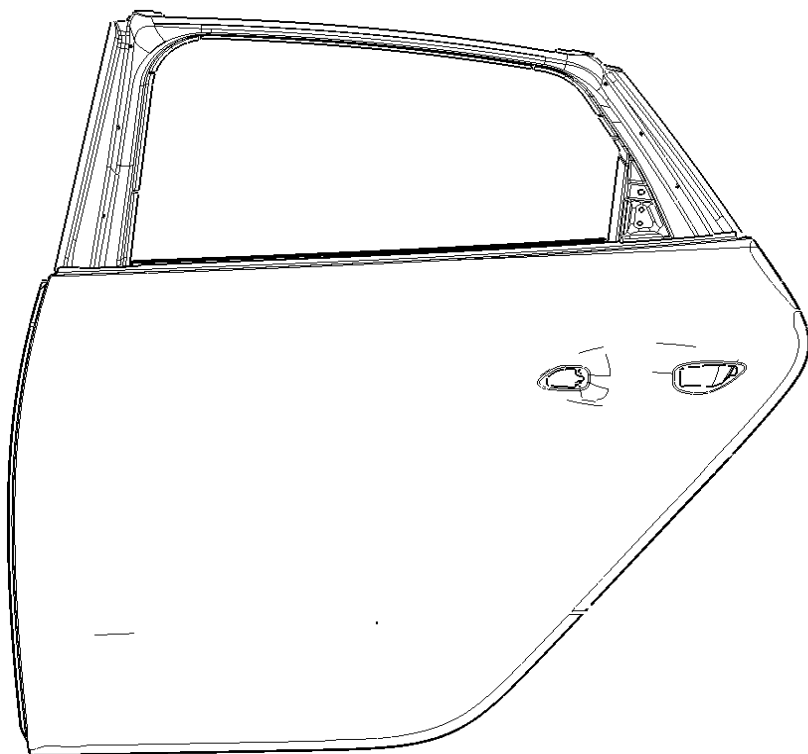

Side Outer Panel (LH/RH)

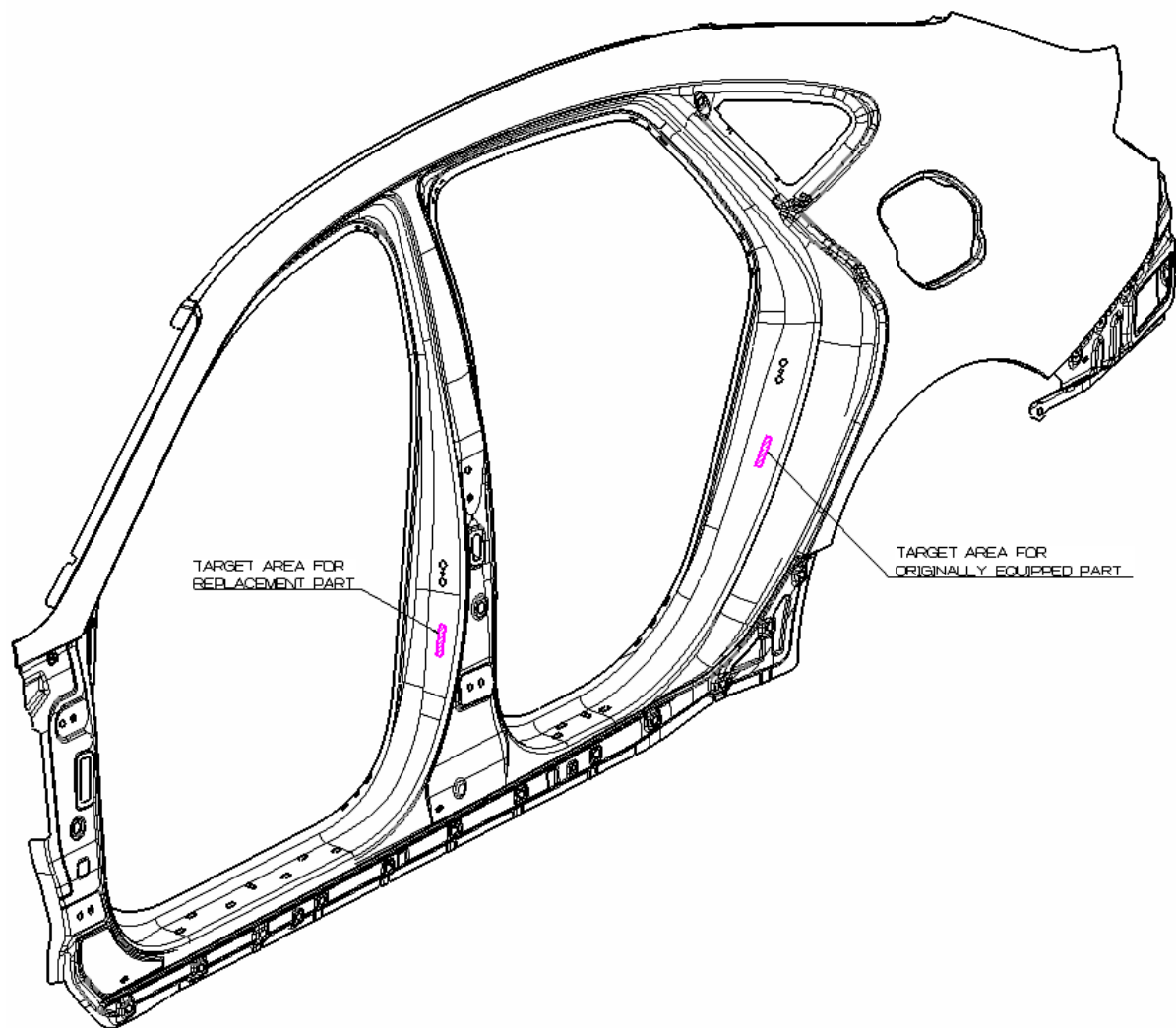

Front Bumper

STD (ORIGINAL)



<FR BUMPER(STD) - BOTTOM VIEW>

STD (REPLACEMENT))



<FR BUMPER(STD) - SIDE VIEW>

OPT (ORIGINAL)



<FR BUMPER(OPT(SPORTS)) - BOTTOM VIEW>

OPT (REPLACEMENT))

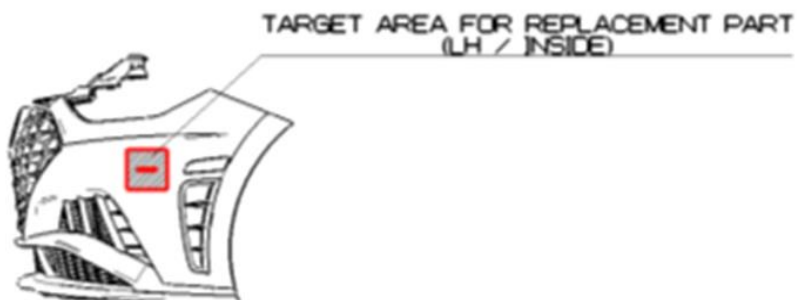

Rear Bumper

STD (ORIGINAL)



<RR BUMPER(STD) - BOTTOM VIEW>

TARGET AREA FOR REPLACEMENT PART (LH / INSIDE)

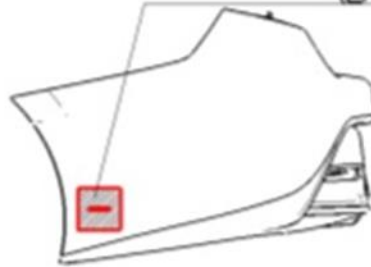

<RR BUMPER(STD) - SIDE VIEW>

OPT (ORIGINAL)

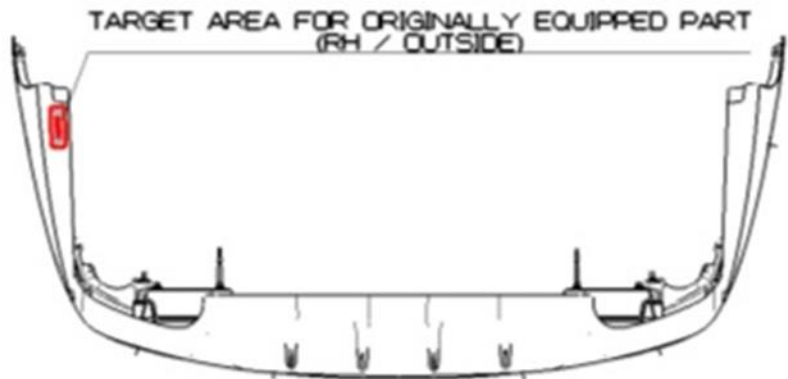

<RR BUMPER(OPT(SPORTS)) - BOTTOM VIEW>

TARGET AREA FOR REPLACEMENT PART (LH / INSIDE)



<RR BUMPER(OPT(SPORTS)) - SIDE VIEW>

OPT (REPLACEMENT))

Engine (G4KIII 2.5)

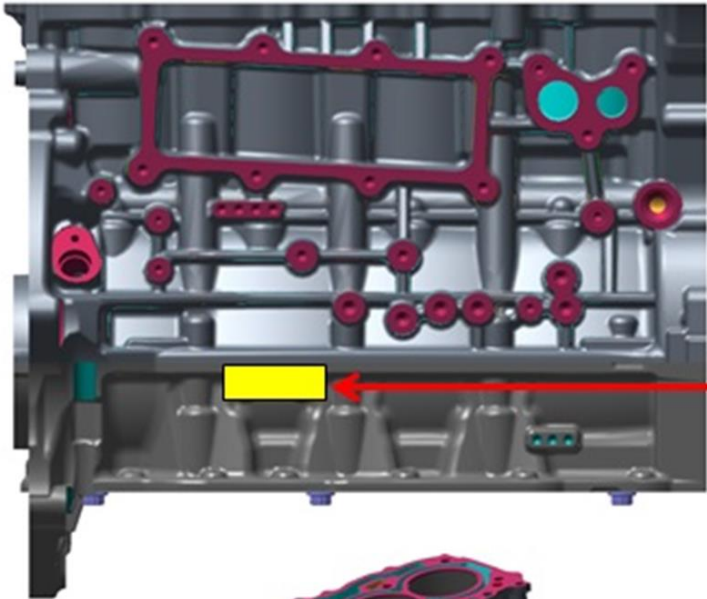

TARGET AREA FOR ORIGINALLY EQUIPPED PART

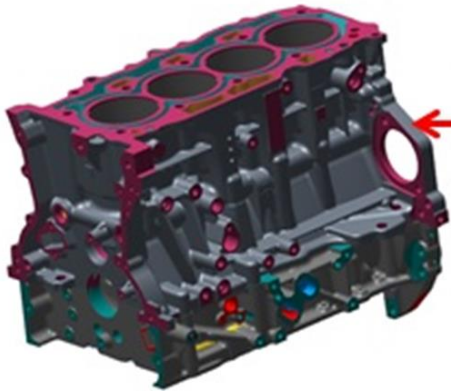

TARGET AREA FOR REPLACEMENT PART

Engine (1.6L T-GDI)

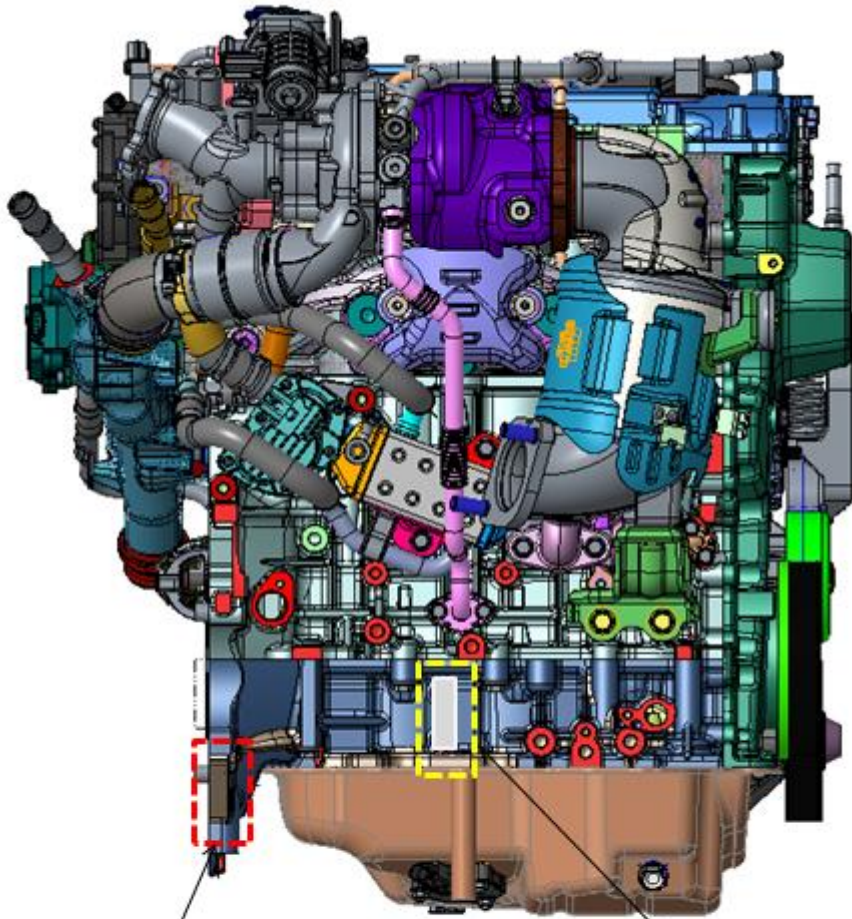

Target area for
replacement part

Target area (V.I.N)
for original equipment
part

Transmission

TARGET AREA FOR
REPLACEMENT PART

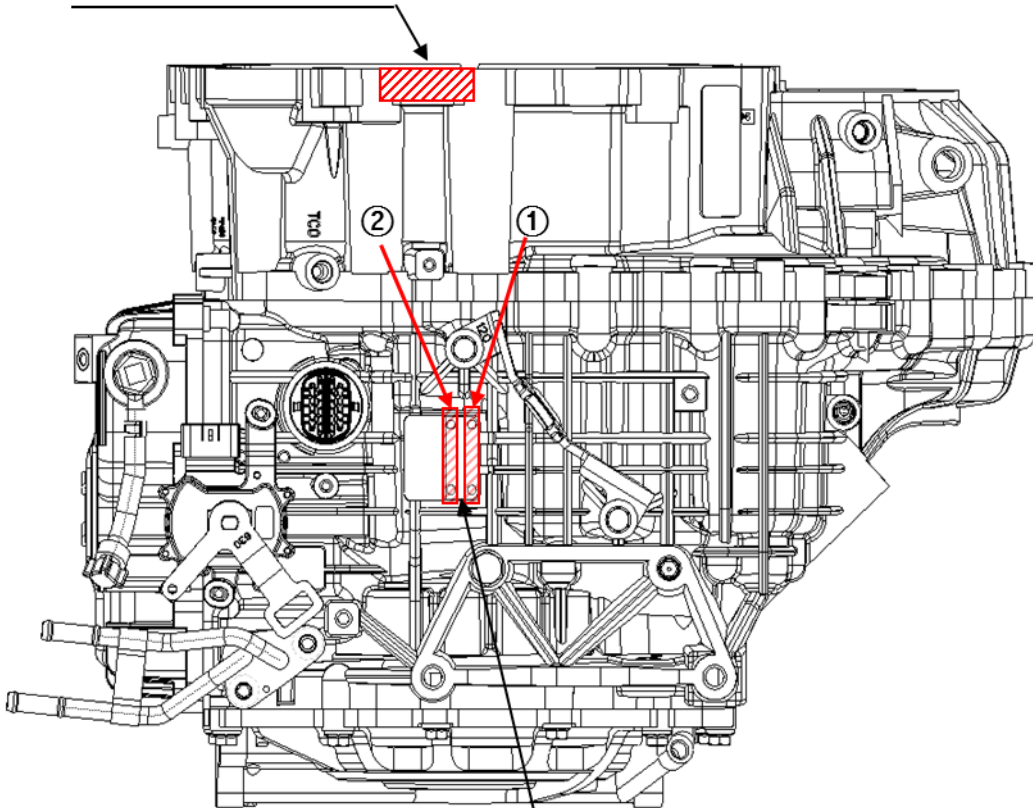

TARGET AREA FOR
ORIGINALLY EQUIPPED PART

※ VIN plate for originally equipped part
will be attached to either ① or ②.