

**NEW CAR ASSESSMENT PROGRAM (NCAP)
DYNAMIC ROLLOVER RESISTANCE TEST**

Ford Motor Company
2015 Lincoln MKC FWD

TEST NUMBER: 15-04

Final Report
17 October 2014



Prepared by:

Dynamic Research, Inc
355 Van Ness Ave. #200
Torrance, CA 90501

Prepared for:

National Highway Traffic Safety Administration
Office of Crash Avoidance Standards
1200 New Jersey Avenue S.E.
Washington, DC 20590

The United States Government assumes no liability for the contents of this report or use thereof. If trade or manufacturers' names or products are mentioned, it is only because they are considered essential to the object of the publication and should not be construed as an endorsement. The United States Government does not endorse products or manufacturers.

Dynamic Research, Inc. does not endorse or certify products of manufacturers. The manufacturer's name appears solely to identify the test article. Dynamic Research, Inc. assumes no liability for the report or use thereof. It is responsible for the facts and the accuracy of the data presented herein. This report does not constitute a standard, specification, or regulation.

Report Prepared by:



John Lenkeit, Program Manager

Date: 17 October 2014

Report Approved by:



Brian Kebschull, Principal Engineer

Date: 17 October 2014

1. Report No. 15-04	2. Government Accession No.	3. Recipient's Catalog No.	
4. Title and Subtitle NCAP Dynamic Rollover Resistance Maneuver (Fishhook) Test of a 2015 Lincoln MKC FWD SUV		5. Report Date 17 October 2014	6. Performing Organization Code DRI
		8. Performing Organization Report No. DRI- TM-14-48	
7. Author(s) John Lenkeit, Program Manager Brian Kebschull, Project Engineer		10. Work Unit No. (TRAIS)	
9. Performing Organization Name and Address Dynamic Research, Inc. 355 Van Ness Ave. #200 Torrance, CA 90501		11. Contract or Grant No. DTNH22-08-D-00117	
		13. Type of Report and Period Covered Final Report September 2014 to October 2014	
12. Sponsoring Agency Name and Address National Highway Traffic Safety Administration Office of Crash Avoidance Standards 1200 New Jersey Avenue S.E. Washington, DC 20590		14. Sponsoring Agency Code	
		15. Supplemental Notes	
16. Abstract An NCAP Dynamic Rollover Maneuver (Fishhook) Test was conducted on a 2015 Lincoln MKC FWD at Dynamic Research, Inc. on September 25, 2014. The vehicle did not experience two-wheel lift. The vehicle's steering angle at 0.3g lateral acceleration at 50 mph was 25.8 degrees.			
17. Key Words NCAP Rollover Resistance Ratings Fishhook Test		18. Distribution Statement Copies of this report are available from: National Highway Traffic Safety Admin. Office of Crash Avoidance Standards 1200 New Jersey Ave., S.E., Room W43-461 Washington, DC 20590	
19. Security Classif. (of this report) Unclassified	20. Security Classif. (of this page) Unclassified	21. Number of Pages 51	22. Price

TABLE OF CONTENTS

	Page
I. INTRODUCTION.....	1
II. VEHICLE PREPARATION	2
A. Test Vehicle	2
B. Tires	2
C. Vehicle Loading.....	2
D. Steering Controller	5
E. Instrumentation and Data Collection	5
F. Other Vehicle Preparation	5
III. TEST PROCEDURES.....	8
A. Test Procedure Overview.....	8
B. Test Conditions	9
IV. RESULTS.....	12
APPENDIX A Photographs	A-1
APPENDIX B Test Run Log.....	B-1
APPENDIX C Slowly Increasing Steer Test Worksheet.....	C-1
APPENDIX D Time History Plots	D-1

LIST OF FIGURES

	Page
1. Nominal Position of Video Cameras for Fishhook Tests	8
2. DRI-Minter Vehicle Dynamics Area	12

LIST OF TABLES

	Page
1. Test Vehicle Data	3
2. Tire Information	4
3. Vehicle Loading	4
4. Sensors	7
5. Surface Friction	10
6. Handwheel Angles	11
7. Weather Conditions	11

Section I INTRODUCTION

Beginning with the 2006 fiscal year, the National Highway Traffic Safety Administration (NHTSA) has engaged Dynamic Research, Inc. (DRI) of Torrance, CA to conduct dynamic rollover testing and gather data from that testing as part of NHTSA's New Car Assessment Program (NCAP).

The purpose of the testing reported herein was to determine if a typical 2015 Lincoln MKC FWD would experience tip-up, defined as simultaneous two-wheel lift of two inches or more at an entry speed of 50 mph or less in the Fishhook Procedure developed by NHTSA. This procedure may be found at www.regulations.gov, docket item NHTSA-2006-26555-0136.

The testing reported herein was accomplished under contract DTNH22-08-D-00117. The task order is entitled, "New Car Assessment Program (NCAP) Non-Destructive Vehicle Testing and Data Gathering."

Section II VEHICLE PREPARATION

A. TEST VEHICLE

The test vehicle was new or in as-new condition, meaning the vehicle had been driven no more than 500 miles prior to the start of dynamic rollover testing. It was acquired through a commercial rental/leasing company. Details of the test vehicle are given in Table 1.

B. TIRES

All tires used were new, and of the same make, model, size, and DOT specification of those installed on the vehicle when purchased new. Tire inflation pressures were in accordance with the recommendations indicated on each vehicle's identification placard. To reduce the possibility of tire debanding during Fishhook testing, an appropriately sized inner tube was installed in each tire. To further reduce the possibility of tire debanding, the tires were mounted to the rims without the use of tire mounting lubricant. Tire specifications are listed in Table 2.

C. VEHICLE LOADING

The multi-passenger load, described in the Fishhook Procedure, was used for all tests. The load and positioning of the load in the vehicle are listed in Table 3.

In addition to water dummies, the loading included instrumentation, a steering machine, and outriggers. Test vehicle bumper assemblies were removed for outrigger installation. The reduction in vehicle weight due to the removal of the bumpers was offset by the additional weight of the outriggers and their mounting system. The outrigger system typically outweighs the bumper assemblies.

Table 1. Test Vehicle Data

General Data					
Model year, make, model	2015 Lincoln MKC FWD				
VIN	5LMCJ1A96FUJ1xxxx				
Body style	SUV				
Number of doors	4				
Trim level	Base				
Seating positions	Front:	2 nd row	3 rd row	4 th row	5 th row
	2	3			
Electronic stability control	Yes				
4-Wheel ABS (Yes/No)	Yes				
Power steering (Yes/No)	Yes				
Major optional equipment	Equipment Group 102A Continuous Control Damping Suspension Enhanced THX Audio System CD MP3 Satellite HD Radio 19" Premium PNT Lustre Nickel Wheels Technology Package Climate Package				
Odometer at start of testing	19 miles				
Drivetrain					
Engine cylinder arrangement	Inline 4				
Engine displacement	2 L				
Transmission type	Automatic				
Drive arrangement	FWD				
Chassis					
Track width	F: 62.4 in (1585 mm) , R: 62.5 in (1587.5 mm)				
Wheelbase	105.9 in (2689.9 mm)				
Curb weight	3893 lb (1765.8 kg)				
Certification Data from Vehicle's Label					
Vehicle manufactured by	Ford Motor Company				
Date of manufacture	07/14				
GVWR	4839 lb (2195 kg)				
GAWR Front	2560 lb (1161 kg)				
GAWR Rear	2299 lb (1043 kg)				

Table 2. Tire Information

Tire Manufacturer	Continental
Tire Model	ContiProContact
Tire Size	Front: 235/45R19 Rear: 235/45R19
Load rating	Front: 95 Rear: 95
Speed rating	Front: H Rear: H
Treadwear grade	Front: 500 Rear: 500
Traction grade	Front: AA Rear: AA
Temperature grade	Front: A Rear: A
Location of "Recommended Tire Pressure" label	Driver side door jamb
Recommended cold tire pressure	Front: 36 psi, (250 kPa) Rear: 36 psi, (250 kPa)
First 8 digits of DOT code	Front: A3E6 47LB Rear: A3E6 47LB

Table 3. Vehicle Loading

Water dummy and other loading	3 water dummies in second row
Water dummy weight	525 lb (238.1 kg)
Fuel level	Full
Weight as Tested	
Left front	1314 lb (596 kg)
Right front	1272 lb (577 kg)
Left rear	1127 lb (511.2 kg)
Right rear	1128 lb (511.7 kg)

D. STEERING CONTROLLER

A programmable steering machine was installed which generates handwheel steering inputs for all test maneuvers. The machine provides at least 35 lb-ft of torque at a handwheel rate of 720 deg/sec, is capable of actuating the vehicle's steering system through its full range, and accepts angular rate sensor feedback input for roll rate-induced steering reversals.

E. INSTRUMENTATION AND DATA COLLECTION

The test vehicle was instrumented with an angle encoder, located in the steering controller; a 3-axis inertial measurement unit to measure roll, pitch, and yaw rates, and longitudinal, lateral, and vertical acceleration; two ultrasonic distance measuring sensors to measure vehicle roll angle; and a radar speed sensor to measure vehicle speed. The brake light circuit was monitored to verify that there was no brake pedal application during any test.

A list of the sensors is given in Table 4. A 3B signal conditioning and power rack was used to provide any necessary sensor power, excitation, gain, and offset. Two pole Butterworth anti-alias filters were used for all analog data channels, using a corner frequency of 20 Hz. Data were collected at 200 samples/sec, using a Measurement Computing Corp. PCI-DAS6402/16 A/D board.

Two video cameras were used to record the Fishhook runs. They were positioned nominally as shown in Figure 1. The recorded videotapes were reviewed after the Fishhook runs to check for any two wheel lift. If any two wheel lift was observed, eight infrared distance measuring sensors for measurement of wheel lift (two sensors at each wheel) were then mounted for use in subsequent confirmation Fishhook tests.

F. OTHER VEHICLE PREPARATION

In addition to installation and preparation discussed above, the test vehicle was prepared as follows:

- Front and rear bumpers were removed
- Outrigger mounts were installed in the bumper locations and titanium outriggers were fastened to these mounts
- A five point safety harness was installed.
- Airbags were removed or otherwise disabled

Photographs of the vehicle tested are given in Appendix A.

Table 4. Sensors

Data Measured	Type	Range	Manufacturer	Model Number
Handwheel angle	Encoder	Infinite	Automotive Testing, Inc.	Angle encoder integral with steering controller
Brake pedal actuation	Tape Switch	On/Off	Vericom Computers	VC3000
Longitudinal, lateral, and vertical acceleration	Multi-axis inertial sensing system	± 2 g	BEI Technologies, Inc., Systron Donner Inertial Division	MP-1
Roll, pitch, and yaw rate		± 100 deg/s		
Left and right side vehicle ride height (to measure roll angle)	Ultrasonic distance measuring system	4 - 40 inches	Massa Products Corp.	M-5000/220kHz
Vehicle speed	Radar speed sensor	0.1 - 125 mph	B+S Software und Messtechnik GmbH	DRS-6
Wheel lift (via resolution of two measured distances spaced a known distance apart), used for confirmation tests only	Analog displacement measuring system (Infrared; 880 mm)	13.8 - 33.5 in	Wenglor Sensors, Ltd.	HT 66MGV80

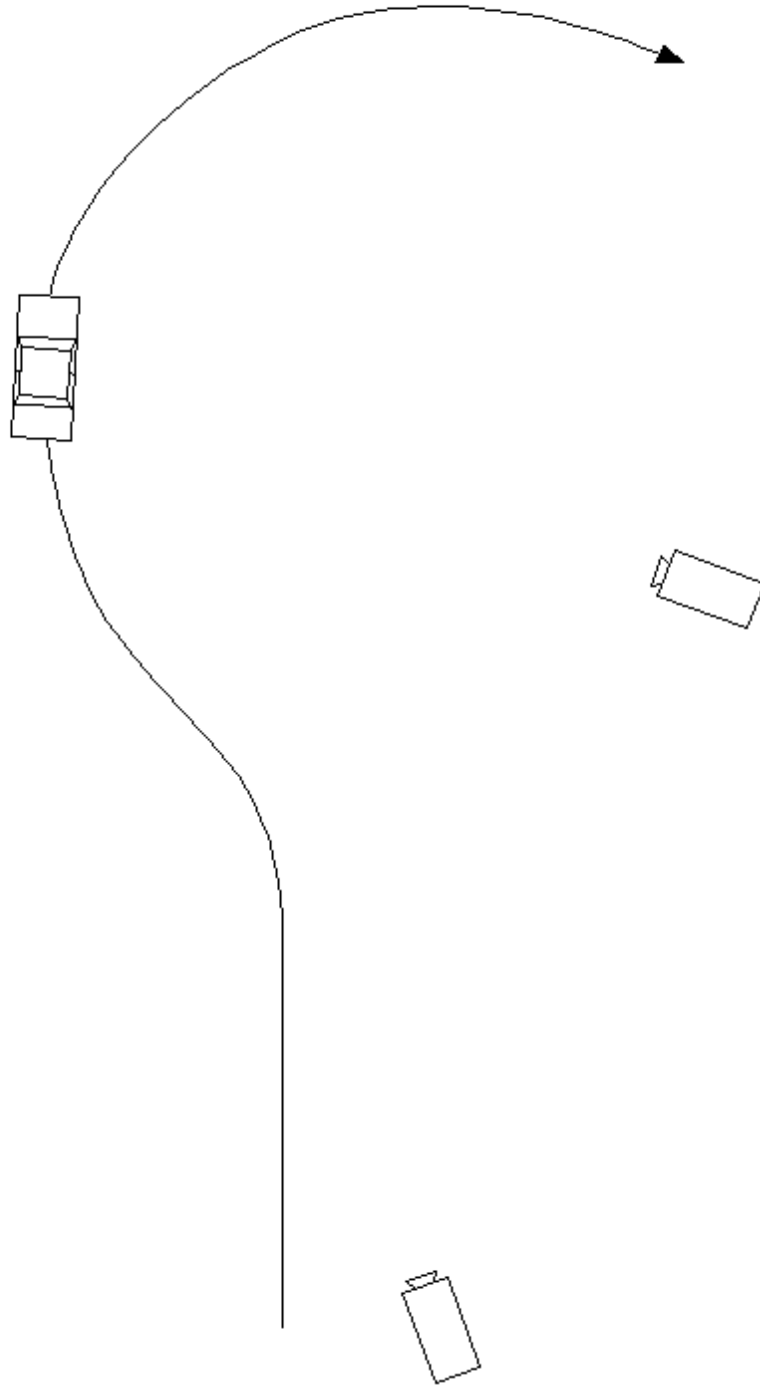

Figure 1. Nominal Position of Video Cameras for Fishhook Tests

Section III TEST PROCEDURES

This section includes a general overview of the test procedures and details of the particular test.

A. TEST PROCEDURE OVERVIEW

This test was conducted in accordance with NHTSA's NCAP Rollover Resistance Test Procedure (Fishhook) as described in the Federal Register (68 FR 59250). Detailed descriptions of the test procedure, pass/fail criteria, and data acquisition specifications may be found at docket NHTSA-2001-9663.

There are two major components of the test procedure, the Slowly Increasing Steer (SIS) pre-test and the Fishhook test.

The Slowly Increasing Steer (SIS) maneuver was used to characterize the steady state lateral dynamics of each vehicle, and is based on the "Constant Speed, Variable Steer" test defined in SAE J266. The maneuver is used to determine the handwheel angle that produces a lateral acceleration of 0.3 g at 50 mph. This handwheel angle is then used to determine the magnitude of steering to be used for the NHTSA Fishhook maneuver.

SIS tests were performed at a constant speed of 50 mph. Handwheel angle was input at a rate of 13.5 deg/sec, from 0 to an angle that provided at least 0.55 g. Three tests were conducted in each direction, and the data for the six runs were averaged to obtain the handwheel angle that produced 0.3 g at 50 mph.

The Fishhook test is a programmed steering maneuver that is implemented via the steering controller. The vehicle was initially steered in one direction and then the steering was reversed. The timing, magnitude and rate of the steering were prescribed by the Fishhook Procedure.

To begin the maneuver, the vehicle was driven in a straight line at a speed slightly greater than the desired entrance speed. The driver then released the throttle. When the vehicle was at the target speed, the steering controller automatically initiated the steering maneuver. Following completion of the steering reversal the handwheel position was maintained for three seconds, and then returned to zero angle in 1 second.

The tests were conducted in both left-right and right-left directions. The “Default” test series used a handwheel angle equal to 6.5 times the handwheel angle that produced 0.3 g at 50 mph in the SIS tests, and initial vehicle speeds beginning at 35 mph and concluding up to 50 mph (if no two-wheel lift occurs). Supplemental tests were also done, as specified in the Fishhook Procedure.

B. TEST CONDITIONS

1. Test Surface

The tests were conducted on the Vehicle Dynamics Area at DRI’s Minter Field facility, located near Bakersfield, California, on 9/25/2014. The VDA has a smooth, flat (slope less than 0.5% throughout) asphaltic concrete surface. Its dimensions are as shown in Figure 2. It was built in the spring of 2005.

VDA surface friction measurements were accomplished using the DRI Mobile Tire Tester. Three runs were done, one at each of three previously determined locations. Each run provided for a minimum of 3 seconds of tire friction at constant normal load, slip angle, and speed in a free rolling condition. The test was accomplished using an ASTM E1136 tire with an inflation pressure of 35 (± 0.5) psi at a test speed of 40 (± 0.5) mph. The net slip angle of the test tire for each test run was 7.5 deg. The test tire was no older than 6 months from the date of manufacture. The surface friction measurement results are shown in Table 5.

Table 5. Surface Friction

Date of surface friction measurements	9/25/2014
Average normalized lateral force	0.833

2. Fishhook Handwheel Angles

The 0.3g handwheel angle obtained from the SIS tests and the handwheel angles used in the Fishhook tests are shown in Table 6.

Table 6. Handwheel Angles

0.3g handwheel angle (from SIS tests at 50 mph)	25.8 °
5.5 scalar handwheel angle for Fishhook Test	168 °
6.5 scalar handwheel angle for Fishhook Test	142 °

3. Weather Conditions

The weather conditions, recorded at the end of testing, are shown in Table 7.

Table 7. Weather Conditions

Ambient temperature	84 °F (28.9 °C)
Wind Speed	7 mph (3.1 m/s)
Wind Direction	N-NW

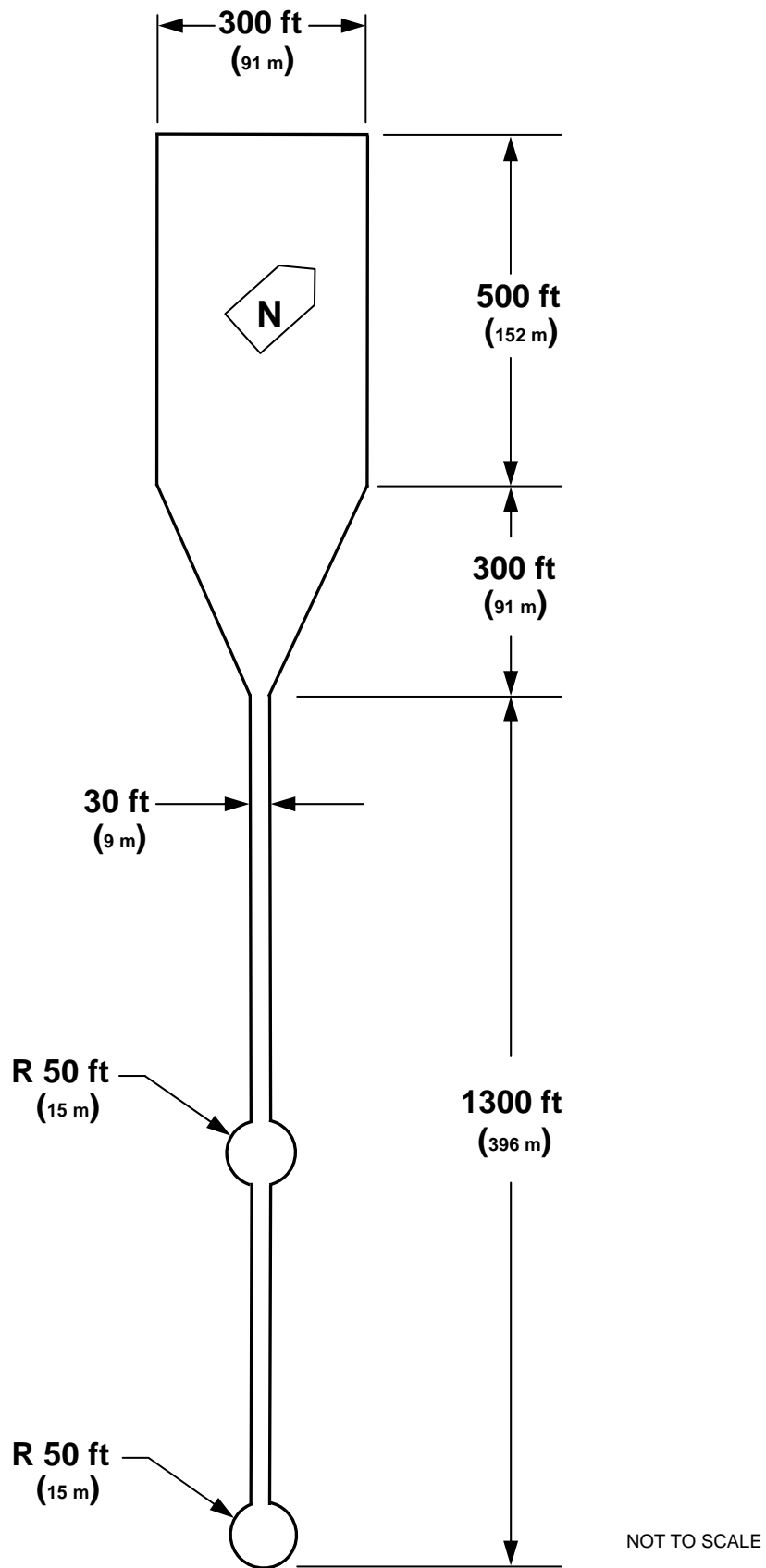

Figure 2. DRI-Minter Vehicle Dynamics Area

Section IV RESULTS

The test run log is given in Appendix B. The Slowly Increasing Steer Test Worksheet is given in Appendix C. Appendix D contains time history plots for the 50 mph runs and any runs which resulted in two-wheel lift. For the 2015 Lincoln MKC FWD, there was no two-wheel lift at any test condition.

APPENDIX A

Photographs

LIST OF FIGURES

	Page
A1. Window Sticker.....	A-3
A2. Front View, Test Vehicle as Delivered	A-4
A3. Rear View, Test Vehicle as Delivered	A-5
A4. Front View, Test Vehicle in Test Condition.....	A-6
A5. Rear View, Test Vehicle in Test Condition	A-7
A6. Instrumentation in Test Vehicle	A-8
A7. Ballast Condition.....	A-9

VEHICLE DESCRIPTION

LINCOLN MKC

2015 LINCOLN MKC FWD
105.9" WHEELBASE
2.0L I4 GTDI ECOBOOST ENG
6-SPD SELECT SHFT AUTO TRAN

FUJ10252

EPA DOT Fuel Economy and Environment Gasoline Vehicle

Fuel Economy

23 MPG
combined city/hwy

20 city 29 highway

4.3 gallons per 100 miles

You spend \$500 more in fuel costs over 5 years compared to the average new vehicle.

Annual fuel cost \$2,300

Fuel Economy & Greenhouse Gas Rating (tailpipe only) **5**

Smog Rating (tailpipe only) **5**

Actual results will vary for many reasons, including driving conditions and how you drive and maintain your vehicle. The average new vehicle gets 24 MPG and costs \$11,000 to fuel over 5 years. Cost estimates are based on 15,000 miles per year at \$3.50 per gallon. MPGe is miles per gasoline gallon equivalent. Vehicle emissions are a significant cause of climate change and smog.

fueleconomy.gov
Calculate personalized estimates and compare vehicles.

GOVERNMENT 5-STAR SAFETY RATINGS

Overall Vehicle Score Not Rated
Based on the combined ratings of frontal, side and rollover. Should ONLY be compared to other vehicles of similar size and weight.

Frontal Crash Driver Passenger Not Rated Not Rated
Based on the risk of injury in a frontal impact. Should ONLY be compared to other vehicles of similar size and weight.

Side Crash Front seat Rear seat Not Rated Not Rated
Based on the risk of injury in a side impact.

Rollover Not Rated
Based on the risk of rollover in a single-vehicle crash.

Star ratings range from 1 to 5 stars (*****), with 5 being the highest.
Source: National Highway Traffic Safety Administration (NHTSA).
www.safercar.gov or 1-888-327-4236

5LMCJ1A96FUJ1

Lincoln ESP is the only extended service plan honored at every Lincoln dealership in the U.S. and Canada. See your Lincoln dealer for additional details or visit www.LincolnOwner.com for more information.

Lincoln AUTOMOTIVE FINANCIAL SERVICES

STANDARD EQUIPMENT INCLUDED AT NO EXTRA CHARGE

EXTERIOR

- HEATED PWR MIRRORS W/ MEM & SECURITY APPROACH LAMPS
- HID HEADLAMPS
- LED TAILLAMPS
- EASY FUEL CAPLESS FILLER
- DUAL EXHAUST SYSTEM - CHROME TIPS

INTERIOR

- DUAL-ZONE ELECTRONIC AUTO CLIMATE CONTROL
- HEATED FRONT SEATS WITH DRIVER'S MEMORY SETTING
- POWER DRVN SEAT - 10-WAY WITH LUMBAR
- 2ND ROW 60/40 FOLD FLAT SPLIT BENCH WIRECLINE
- LEATHER WRAPPED STR WHEEL W/CRUISE AND AUDIO CONTR
- LINCOLN WELCOME/FAREWELL ELEMENTS
- FLOORMATS-1ST AND 2ND ROW

FUNCTIONAL

- SYNC W/ MYLINCOLN TOUCH
- SIRIUS SAT RADIO N/A AXI/H
- REMOTE KEYLESS W/KEYPAD
- ELECTRIC PWR ASST STEERING
- ACTIVE NOISE CONTROL
- INTELLIGENT ACCESS W/PUSH BUTTON START
- PUSH BUTTON SHIFT
- REMOTE START
- REVERSE SENSING SYSTEM
- ELECTRONIC PARKING BRAKE
- TRANSMISSION-SELECTSHIFT
- TRACTION CONTROL
- ANTI-LOCK BRAKING SYSTEM
- HILL START ASSIST

SAFETY/SECURITY

- ADVANCETRAC WITH RSC
- DUAL STAGE FRONT AIRBAGS
- AIR BAG - DRIVER KNEE
- AIRBAGS - SIDE IMPACT / CURTAINS
- PASSIVE ANTI-THEFT SECURILOCK SYSTEM
- PERIMETER ANTI-THEFT SYSTEM
- SOS POST CRASH SYSTEM

WARRANTY

- 4YR/50K MILE WARRANTY
- 6YR/70K MI POWERTRAIN WARR
- 2YR/24K COMP MAINTENANCE

INCLUDED ON THIS VEHICLE (MSRP)

EQUIPMENT GROUP 102A 6,935.00

RESERVE EQUIPMENT GROUP

PANORAMIC VISTA ROOF

NAVIGATION W/VOICE RECOGNITIO

HILLS W/CRUISE TRAFFIC ALERT

HEATED & COOLED FRONT SEATS

ADUAL PWR AUTO FLD HTD MIRRORS

HANDS FREE LIFTGATE

ADCONFIGURABLE DAYTIME RUN LMP

OPTIONAL EQUIPMENT

CONT CNTRL DAMPING SUSPENSION 650.00

ENHANCED THX AUDIO SOUND SYS 995.00

SINGLE CD/MP3 SAT HD RADIO NO CHARGE

P1P PREM PNT LUSTR NCKL WHEELS 395.00

REVERSIBLE CARGO MAT 50.00

TECHNOLOGY PACKAGE 2,235.00

ACTIVE PARK ASSIST

ADAPTIVE CRUISE CNT W/COL WRN

FORWARD SENSING SYSTEM

LANE KEEPING SYSTEM

CLIMATE PACKAGE 580.00

HEATED STEERING WHEEL

FRONT LICENSE PLATE BRACKET NO CHARGE

PRICE INFORMATION (MSRP)

BASE PRICE 533,100.00

TOTAL OPTIONS 11,840.00

TOTAL VEHICLE & OPTIONS 44,940.00

DESTINATION & DELIVERY 895.00

TOTAL MSRP \$45,835.00

This label is affixed pursuant to the Federal Automobile Information Disclosure Act. Gasoline, License, and Title Fees, State and Local taxes are not included. Dealer installed options or accessories are not included unless listed above.

RECIPT	RAMP ONE	DEALER NO.	
	CH27		
RECIPT IF OTHER THAN SOLD TO	RAMP TWO	FINAL ASSEMBLY PLANT	
		LOUISVILLE	
SHIP THROUGH	METHOD OF TRANSF.	ITEM #	54-L194 0/7 2
	CONVOY		
		E6241 N RD 2X 515 000868 07 24 14	

Figure A1. Window Sticker



Figure A2. Front View, Test Vehicle as Delivered



Figure A3. Rear View, Test Vehicle as Delivered



Figure A4. Front View, Test Vehicle in Test Condition



Figure A5. Rear View, Test Vehicle in Test Condition



Figure A6. Instrumentation in Test Vehicle



Figure A7. Ballast Condition

APPENDIX B

Test Run Log

Vehicle: **2015 Lincoln MKC FWD**Driver: **Theresa Cornwell**Date: **9/25/2014**

Run Number	Test Type	Speed (mph)	Handwheel Angle (deg)	Dir. of First Steer	2 Wheel Lift	Notes
0	Distance		0	NA	NA	Distance Calibration (ft): 1000.3
1	Tire Warm-Up	35	120	NA	NA	
2	Tire Warm-Up	35	110	NA	NA	
3	Tire Warm-Up	35	110	NA	NA	
4	Tire Warm-Up	35	110	NA	NA	
5	Static	0	0	NA	NA	
6	Dynamic	50	0	NA	NA	
7	SIS	50	50	Left	NA	
8	SIS	50	50	Left	NA	
9	SIS	50	50	Left	NA	
10	SIS	50	50	Right	NA	
11	SIS	50	50	Right	NA	
12	SIS	50	50	Right	NA	
13	Fishhook	35	186	Left	No	6.5x scalar
14	Fishhook	40	186	Left	No	
15	Fishhook	45	186	Left	No	
16	Fishhook	47.5	186	Left	No	NG
17	Fishhook	47.5	186	Left	No	
18	Fishhook	50	186	Left	No	NG
19	Fishhook	50	186	Left	No	
20	Fishhook	35	186	Right	No	
21	Fishhook	40	186	Right	No	
22	Fishhook	45	186	Right	No	
23	Fishhook	47.5	186	Right	No	
24	Fishhook	50	186	Right	No	

Vehicle: **2015 Lincoln MKC FWD**Driver: **Theresa Cornwell**Date: **9/25/2014**

Run Number	Test Type	Speed (mph)	Handwheel Angle (deg)	Dir. of First Steer	2 Wheel Lift	Notes
25	Fishhook	45	142	Right	No	5.5x scalar
26	Fishhook	47.5	142	Right	No	
27	Fishhook	50	142	Right	No	
28	Fishhook	45	142	Left	No	
29	Fishhook	47.5	142	Left	No	
30	Fishhook	50	142	Left	No	

APPENDIX C

Slowly Increasing Steer Test Worksheet

NCAP, 2015 Lincoln MKC FWD , Multi-Passenger Load, Test Date: 9/25/2014

SIS_out_v2

Run	Dir of Steer	Start Speed (mph)	End Speed (mph)	Speed Red. (%)	Index of ay @ 0.3g	HW Angle (deg) at 0.3g	ay (g) @ 0.3g index	6.5x HW Angle (deg)	Ramp Time (sec) at 6.5x	5.5x HW Angle (deg)	Ramp Time (sec) at 5.5x	R2	Zero Begin Index	Zero End Index
7	1	50.5	4.7	90.6	1040	-24.2	-0.295	-157.4	-0.2186	-133.2	-0.185	0.9981	498	698
8	1	50.3	17.1	66	1048	-24.8	-0.304	-161	-0.2236	-136.2	-0.1892	0.9965	400	600
9	1	50.4	10.3	79.6	1067	-25.7	-0.305	-167	-0.2319	-141.3	-0.1962	0.9968	503	703
10	0	50.6	10.9	78.4	1057	27	0.292	175.3	0.2434	148.3	0.206	0.9922	473	673
11	0	50.6	14.1	72.1	1057	26.5	0.306	172.3	0.2394	145.8	0.2025	0.9864	478	678
12	0	50.5	10	80.2	1069	26.9	0.308	175.1	0.2432	148.2	0.2058	0.9912	490	690

Mean: 25.8 0.302 168 0.233 142 0.197

Steering Controller Input Values

Scalar 6.5 values:

Initial HW angle: 168 deg
Initial time: 0.233 s
Reversal HW angle: -168 deg
Reversal time: 0.467 s

Scalar 5.5 values:

Initial HW angle: 142 deg
Initial time: 0.197 s
Reversal HW angle: -142 deg
Reversal time: 0.395 s

APPENDIX D

Time History Plots

LIST OF FIGURES

	Page
D1. Vehicle Speed, Handwheel Angle, and Roll Angle Time History Plots for Default Test Series, L-R, 50 mph	D-3
D2. Steering Machine Operation Time History Plots for Default Test Series, L-R, 50 mph.....	D-4
D3. Yaw Rate, Roll Rate, and Lateral Acceleration Time History Plots for Default Test Series, L-R, 50 mph	D-5
D4. Pitch Rate and Longitudinal Acceleration Time History Plots for Default Test Series, L-R, 50 mph	D-6
D5. Vehicle Speed, Handwheel Angle, and Roll Angle Time History Plots for Default Test Series, R-L, 50 mph	D-7
D6. Steering Machine Operation Time History Plots for Default Test Series, R-L, 50 mph	D-8
D7. Yaw Rate, Roll Rate, and Lateral Acceleration Time History Plots for Default Test Series, R-L, 50 mph	D-9
D8. Pitch Rate and Longitudinal Acceleration Time History Plots for Default Test Series, R-L, 50 mph	D-10
D9. Vehicle Speed, Handwheel Angle, and Roll Angle Time History Plots for Supplemental 2 Test Series, L-R, 50 mph.....	D-11
D10. Steering Machine Operation Time History Plots for Supplemental 2 Test Series, L-R, 50 mph	D-12
D11. Yaw Rate, Roll Rate, and Lateral Acceleration Time History Plots for Supplemental 2 Test Series, L-R, 50 mph	D-13
D12. Pitch Rate and Longitudinal Acceleration Time History Plots for Supplemental 2 Test Series, L-R, 50 mph	D-14
D13. Vehicle Speed, Handwheel Angle, and Roll Angle Time History Plots for Supplemental 2 Test Series, R-L, 50 mph.....	D-15
D14. Steering Machine Operation Time History Plots for Supplemental 2 Test Series, R-L, 50 mph	D-16
D15. Yaw Rate, Roll Rate, and Lateral Acceleration Time History Plots for Supplemental 2 Test Series, R-L, 50 mph	D-17
D16. Pitch Rate and Longitudinal Acceleration Time History Plots for Supplemental 2 Test Series, R-L, 50 mph	D-18

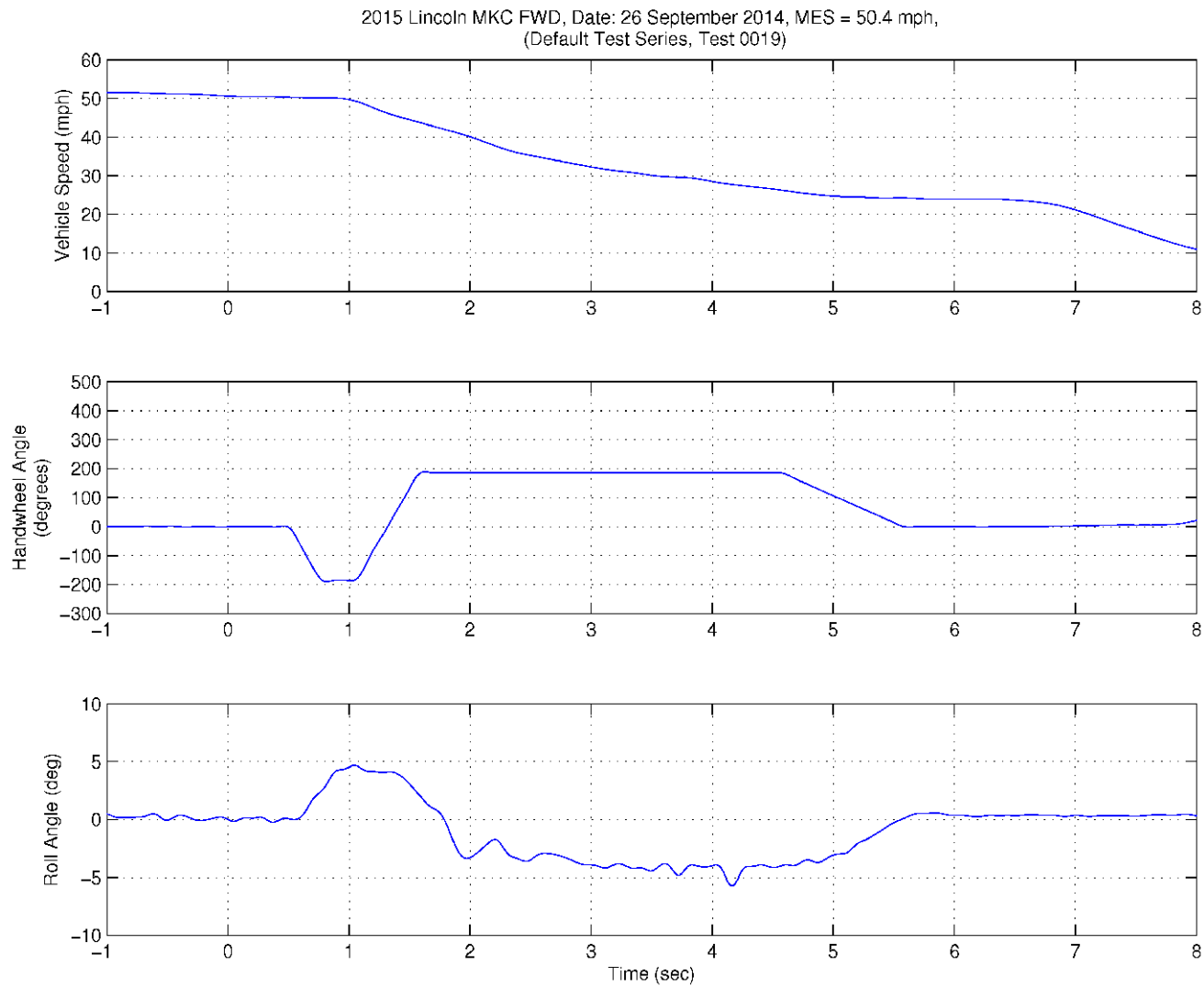

Figure D1. Vehicle Speed, Handwheel Angle, and Roll Angle Time History Plots for Default Test Series, L-R, 50 mph

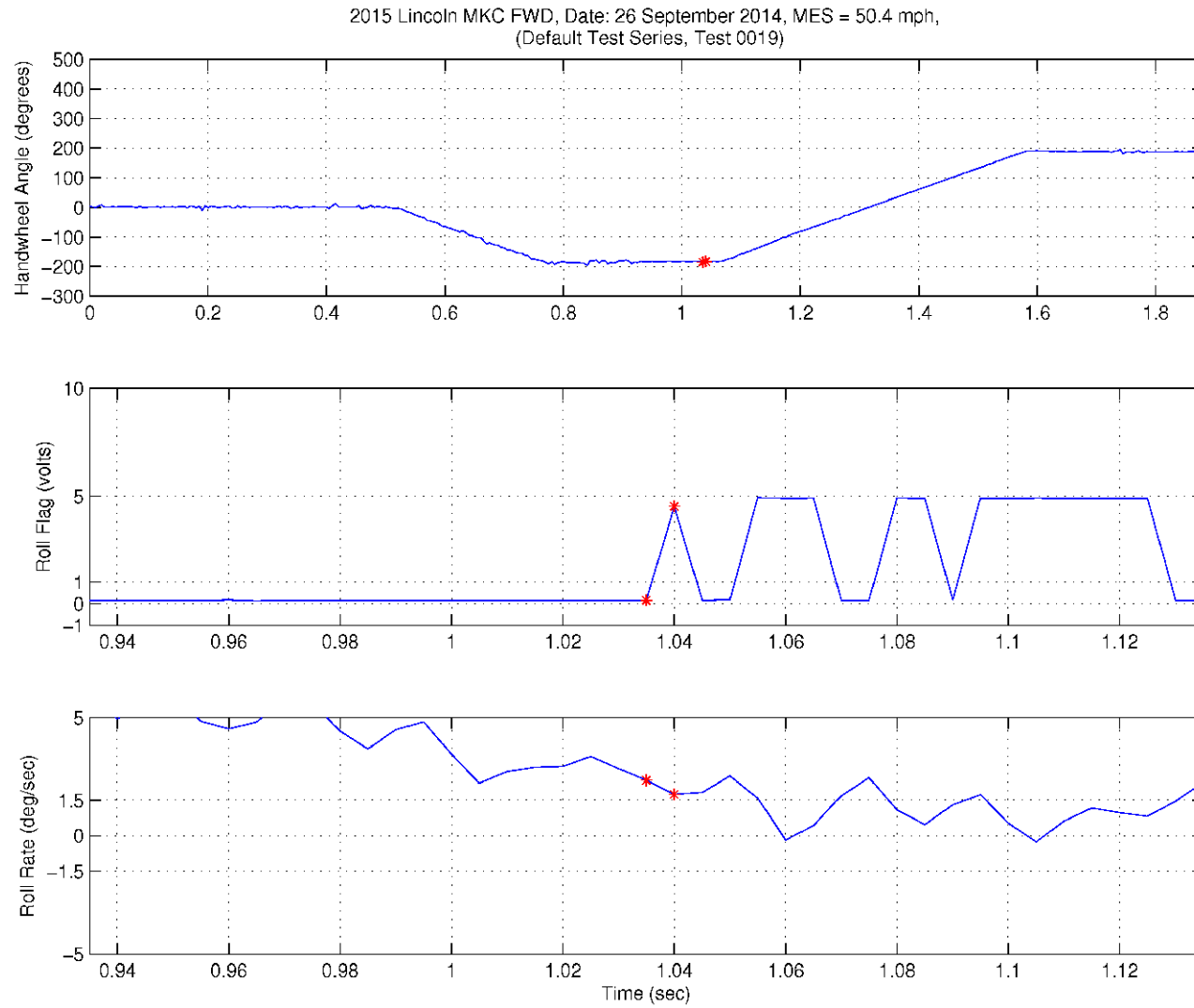

Figure D2. Steering Machine Operation Time History Plots for Default Test Series, L-R, 50 mph

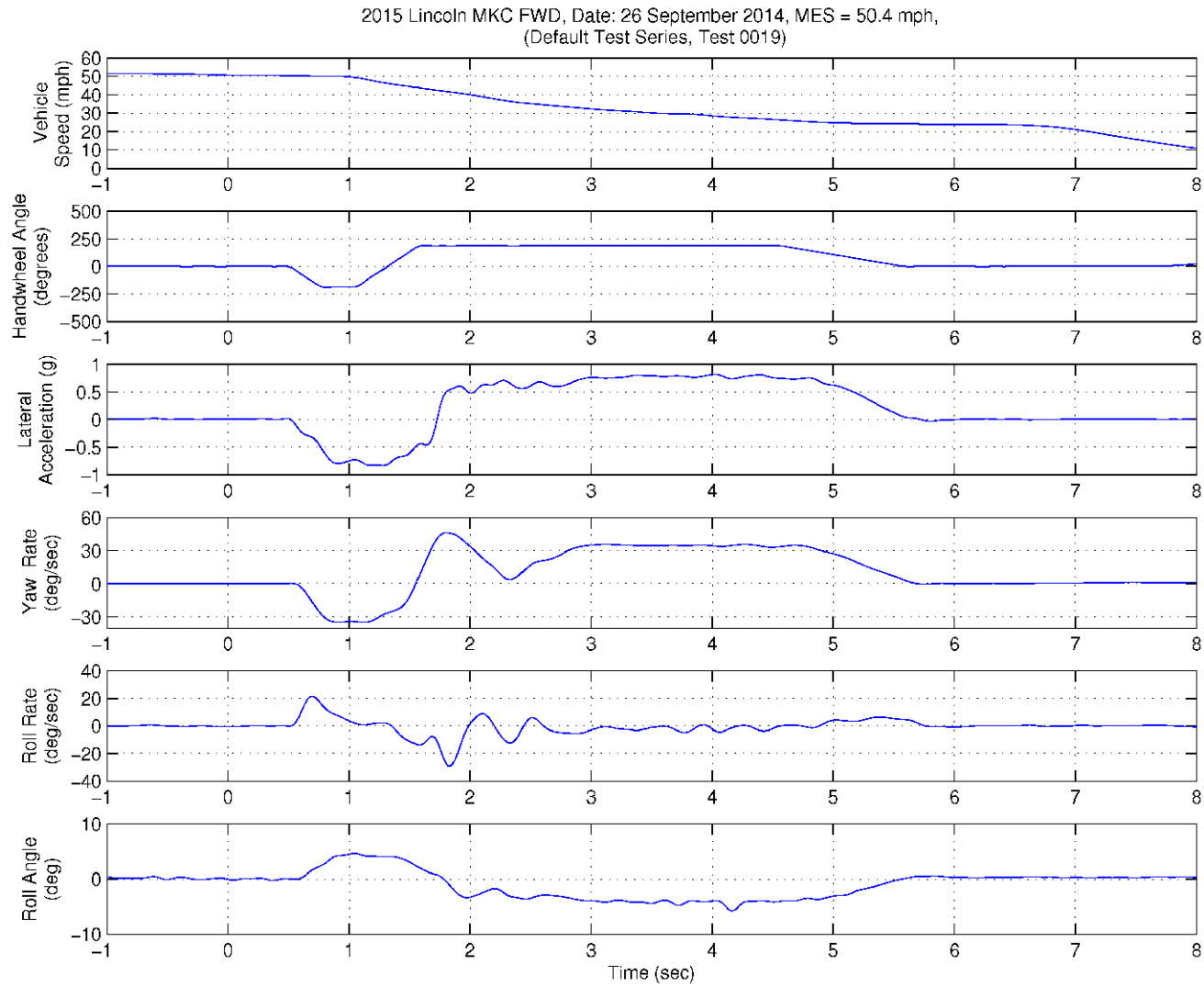

Figure D3. Yaw Rate, Roll Rate, and Lateral Acceleration Time History Plots For Default Test Series, L-R, 50 mph

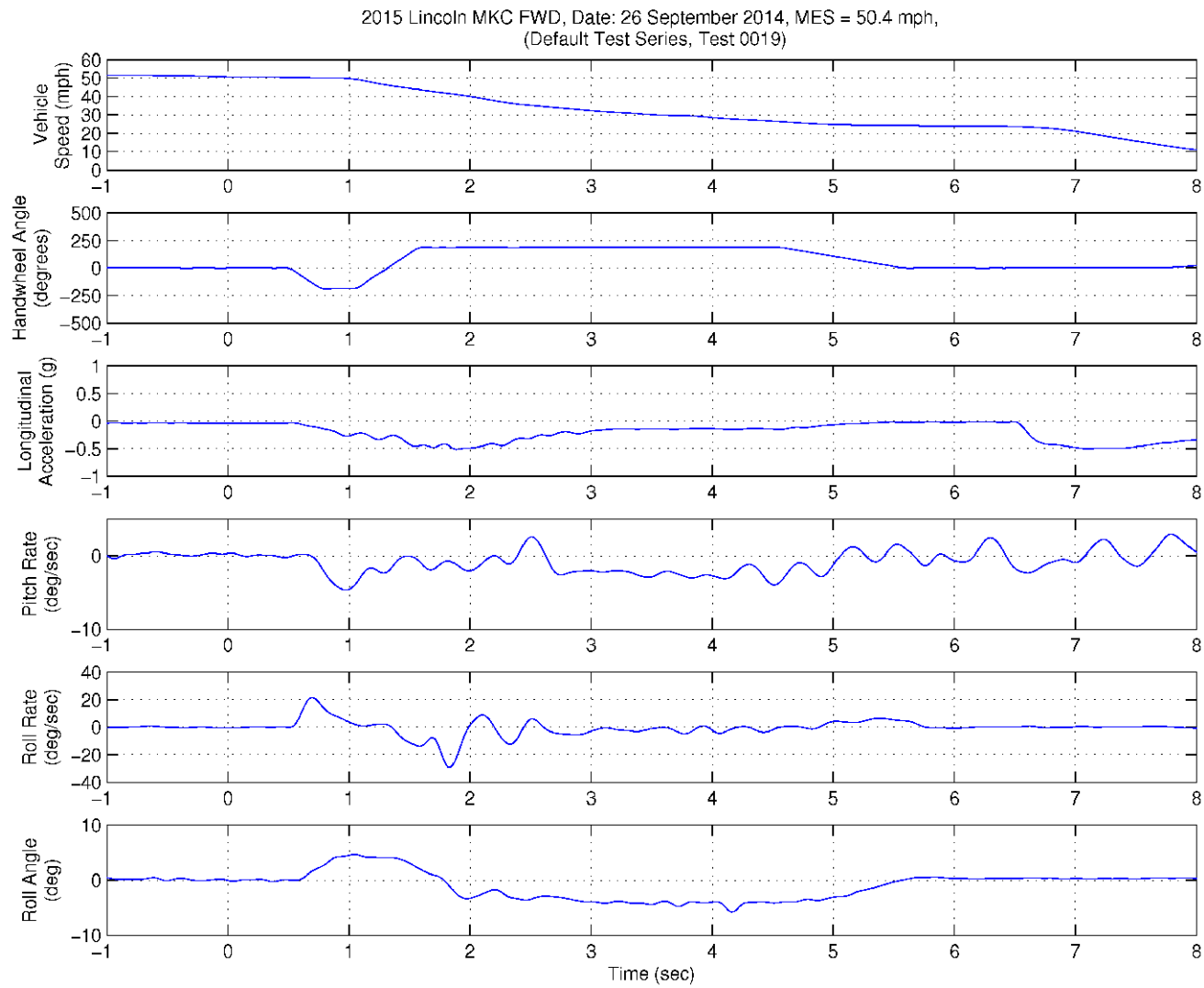

Figure D4. Pitch Rate and Longitudinal Acceleration Time History Plots for Default Test Series, L-R, 50 mph

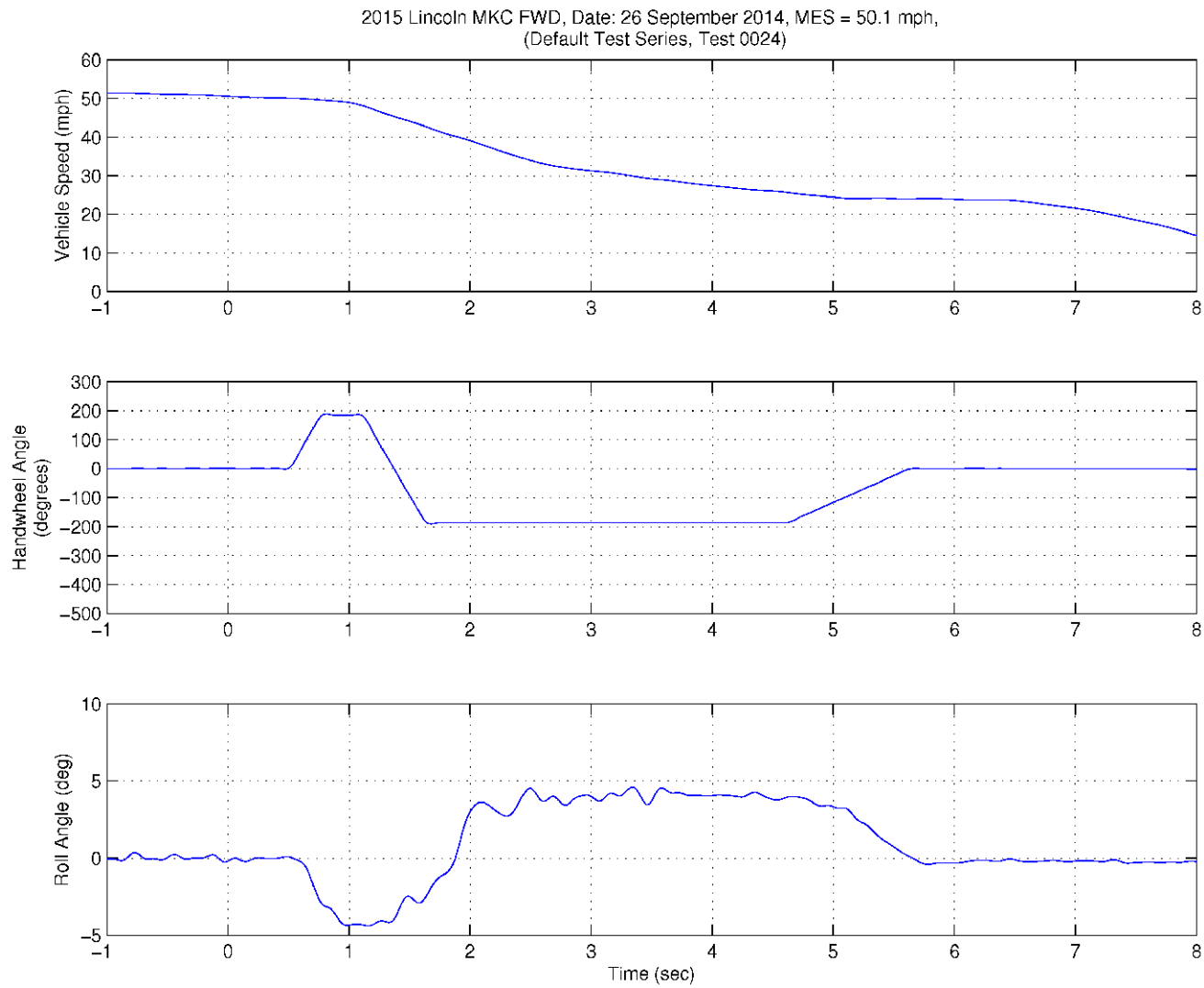

Figure D5. Vehicle Speed, Handwheel Angle, and Roll Angle Time History Plots for Default Test Series, R-L, 50 mph

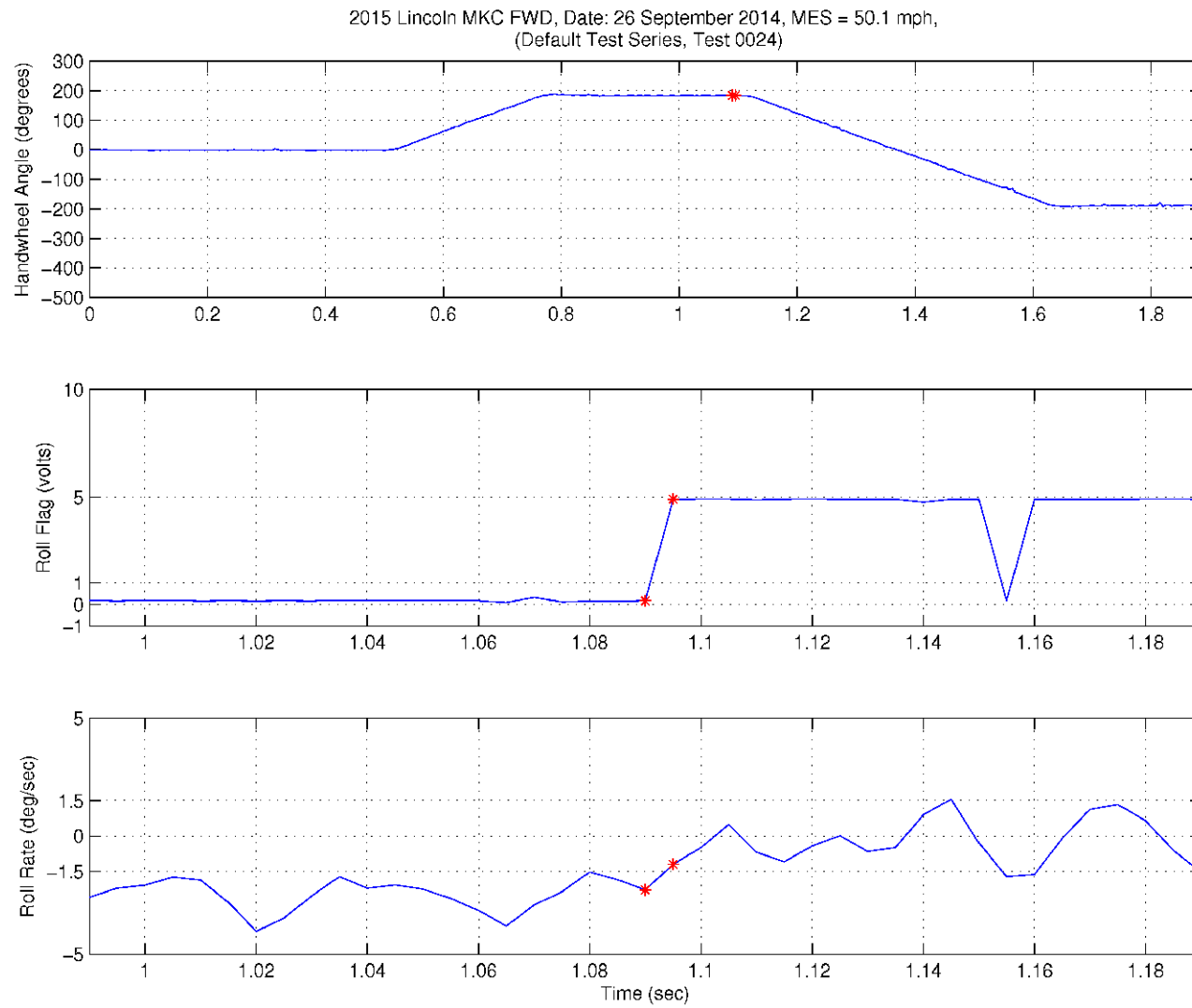

Figure D6. Steering Machine Operation Time History Plots for Default Test Series, R-L, 50 mph

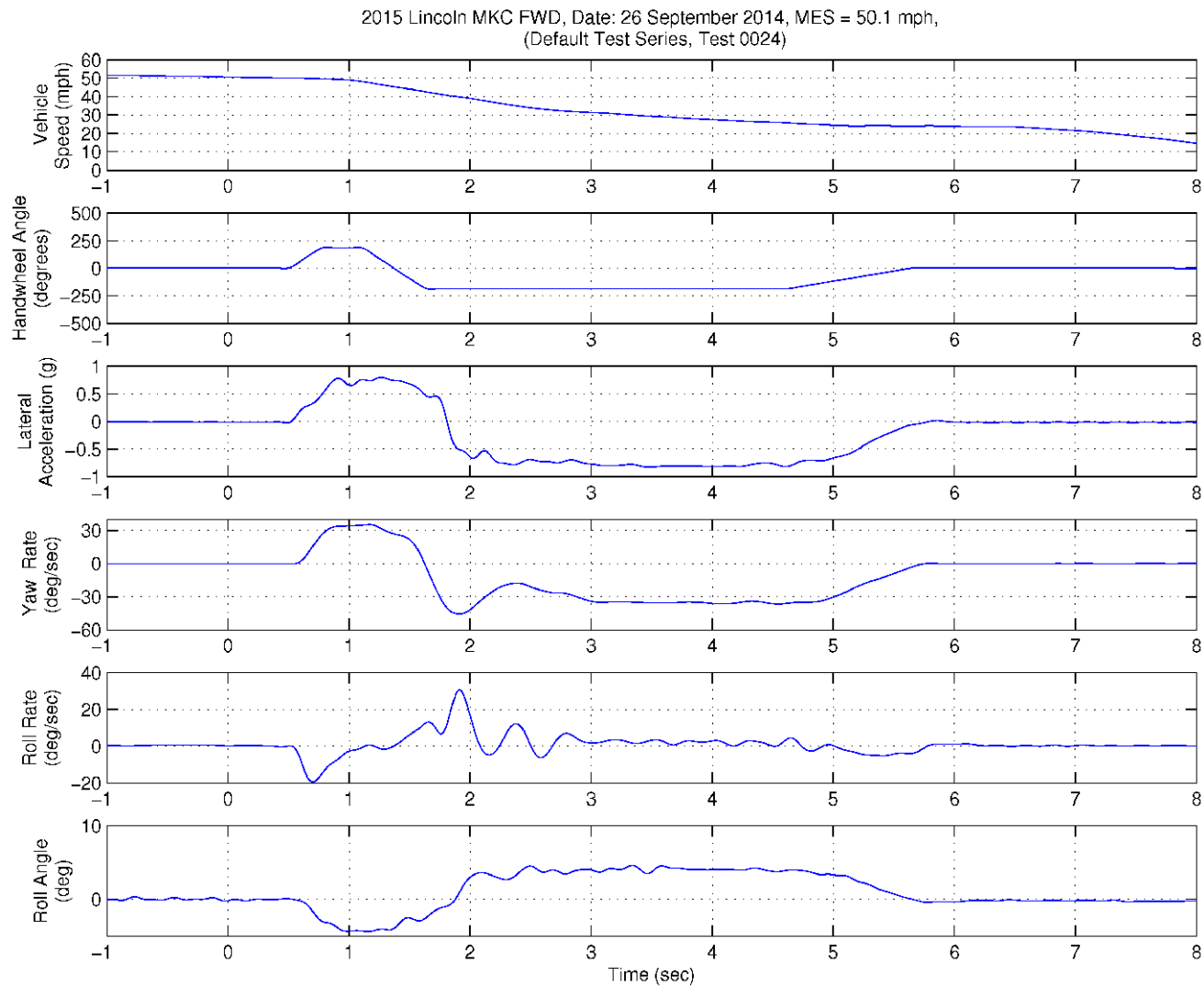

Figure D7. Yaw Rate, Roll Rate, and Lateral Acceleration Time History Plots for Default Test Series, R-L, 50 mph

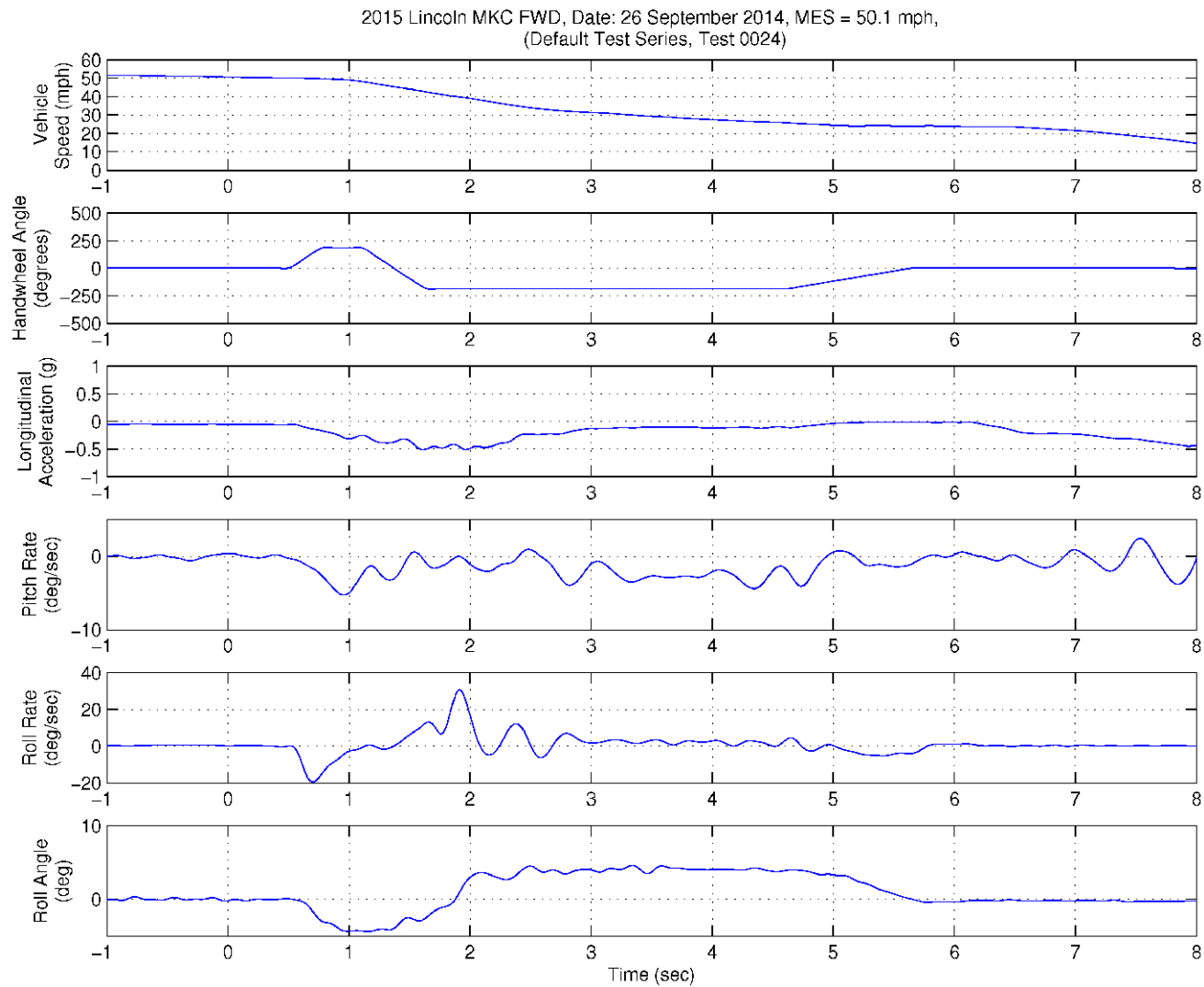

Figure D8. Pitch Rate and Longitudinal Acceleration Time History Plots or Default Test Series, R-L, 50 mph

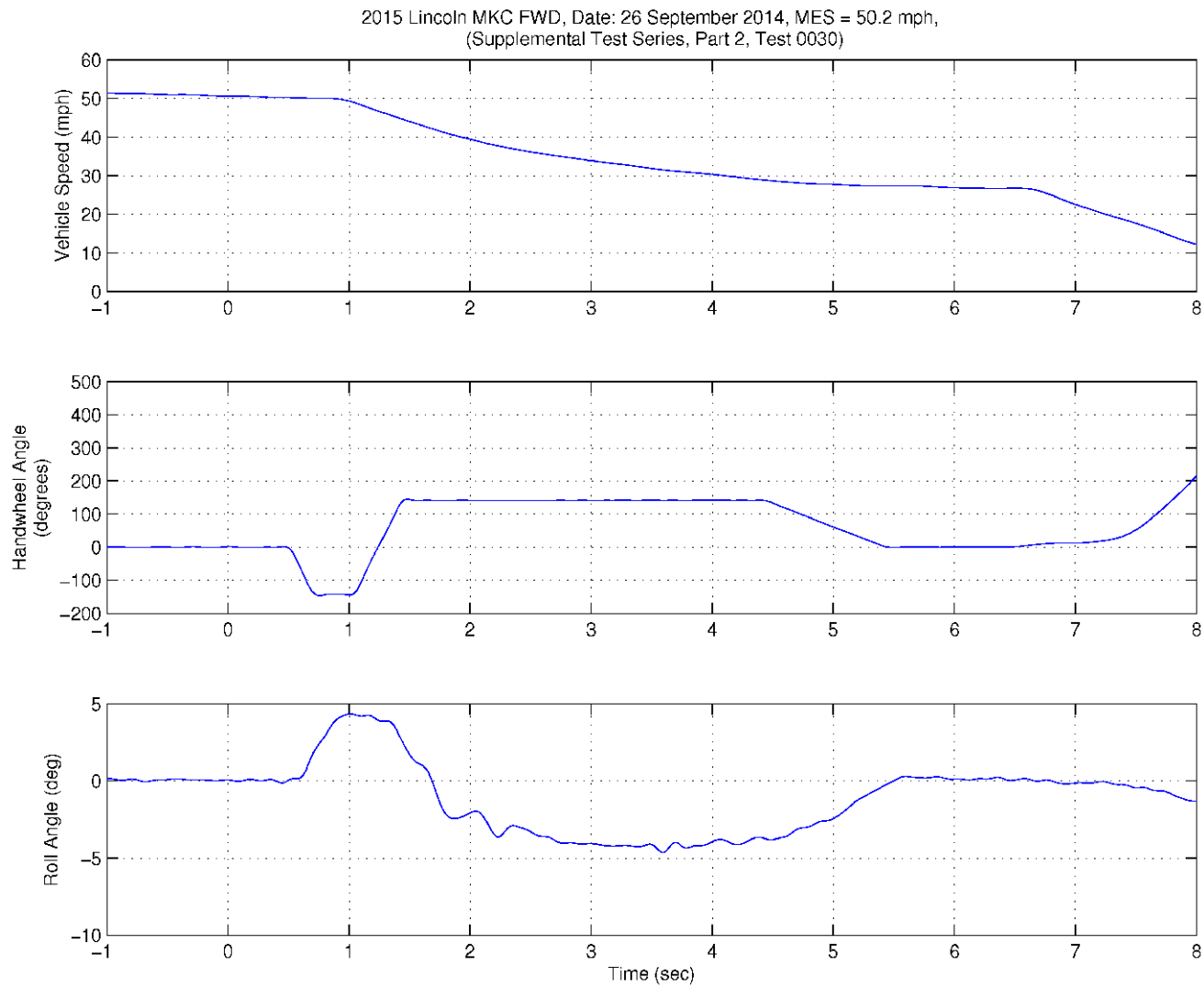

Figure D9. Vehicle Speed, Handwheel Angle, and Roll Angle Time History Plots for Supplemental 2 Test Series, L-R, 50 mph

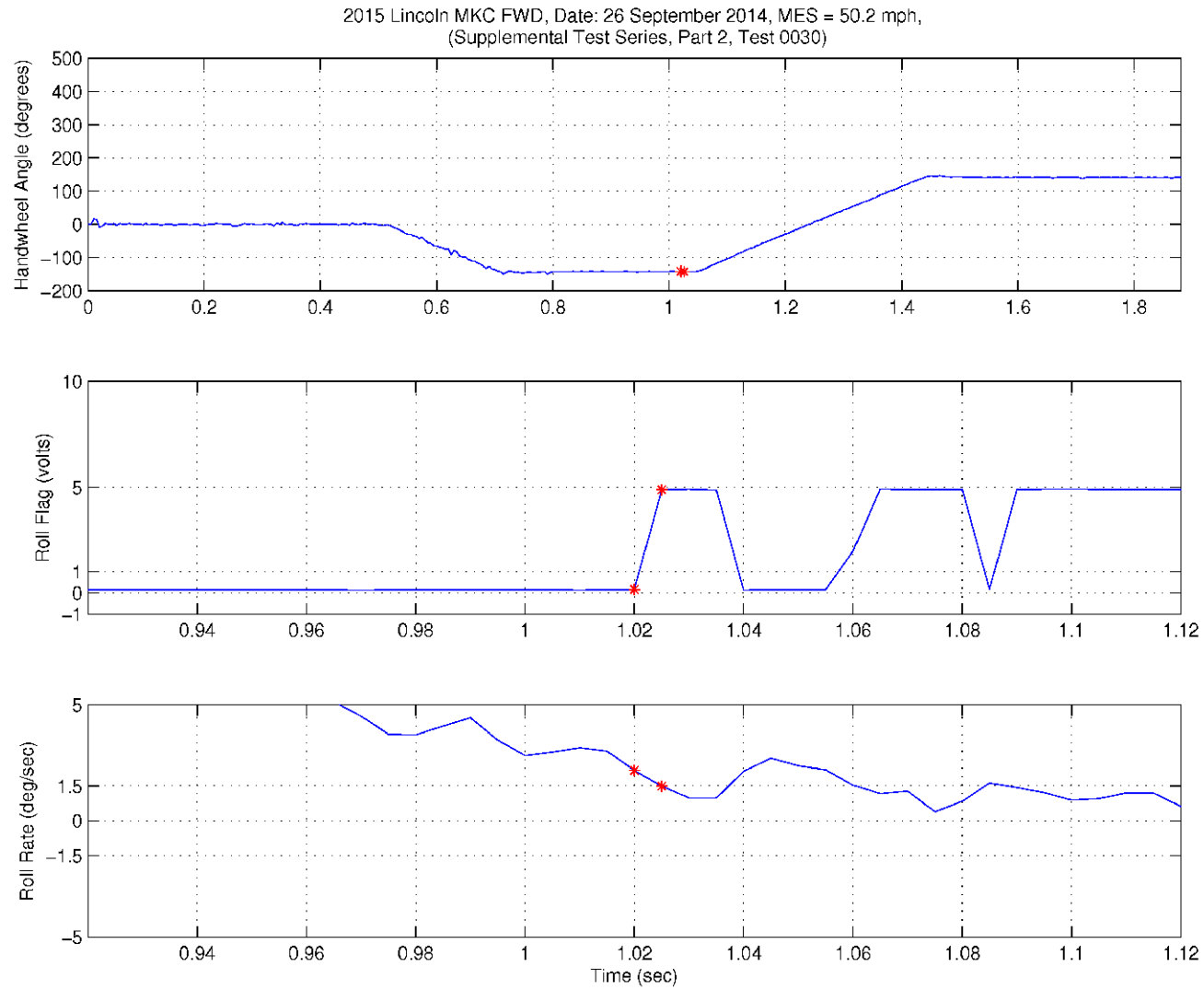

Figure D10. Steering Machine Operation Time History Plots for Supplemental 2 Test Series, L-R, 50 mph

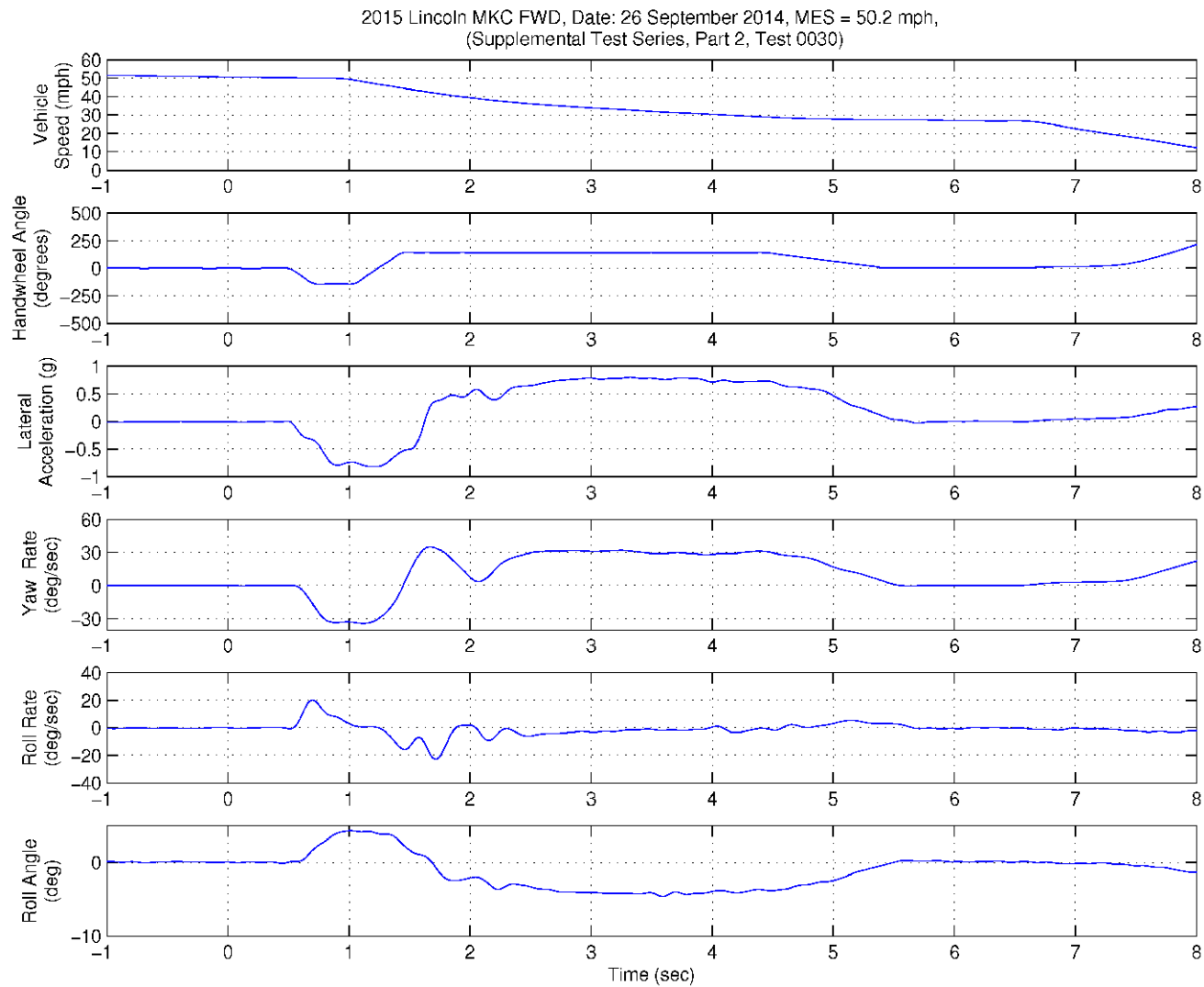

Figure D11. Yaw Rate, Roll Rate, and Lateral Acceleration Time History Plots for Supplemental 2 Test Series, L-R, 50 mph

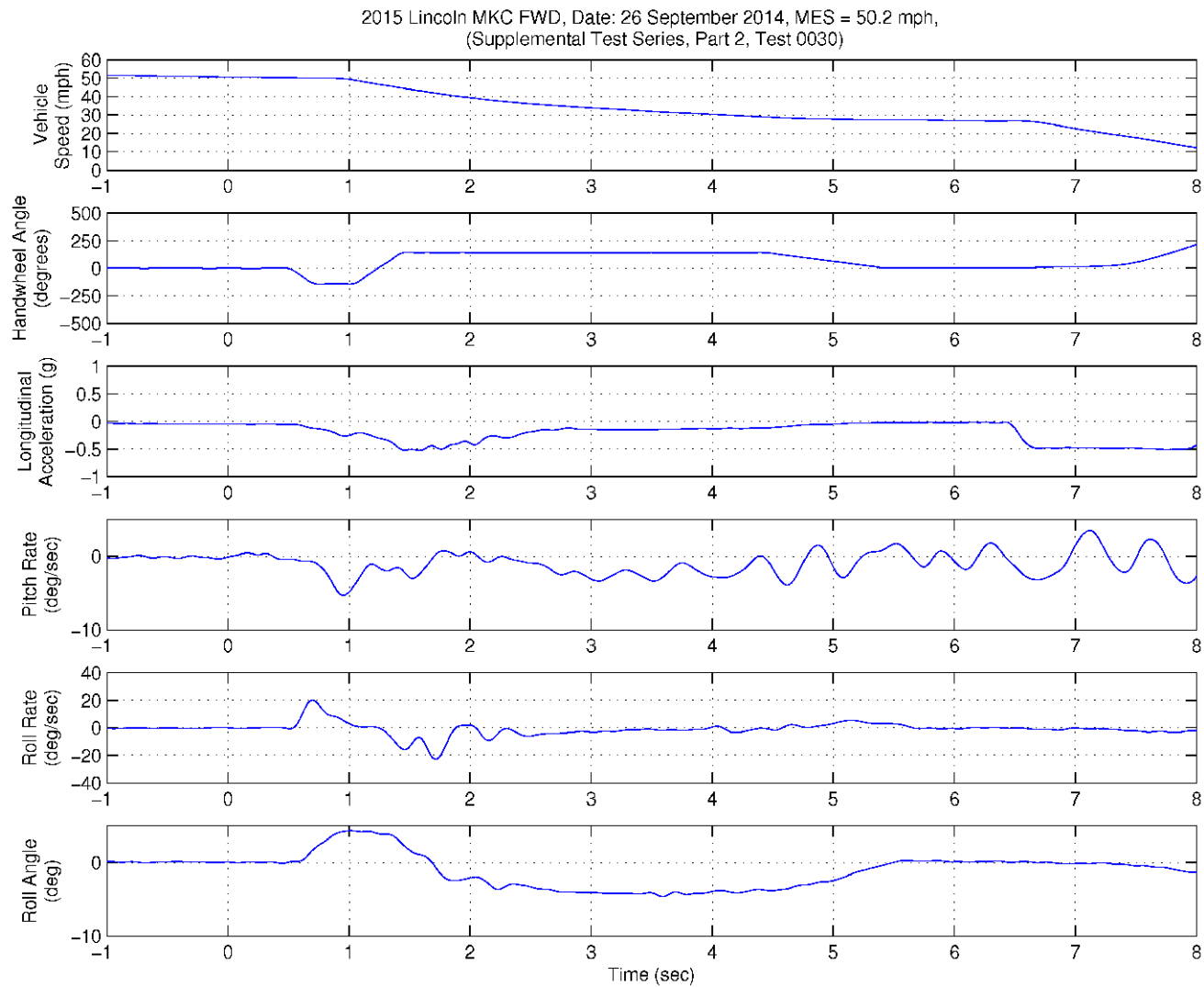

Figure D12. Pitch Rate and Longitudinal Acceleration Time History Plots for Supplemental 2 Test Series, L-R, 50 mph

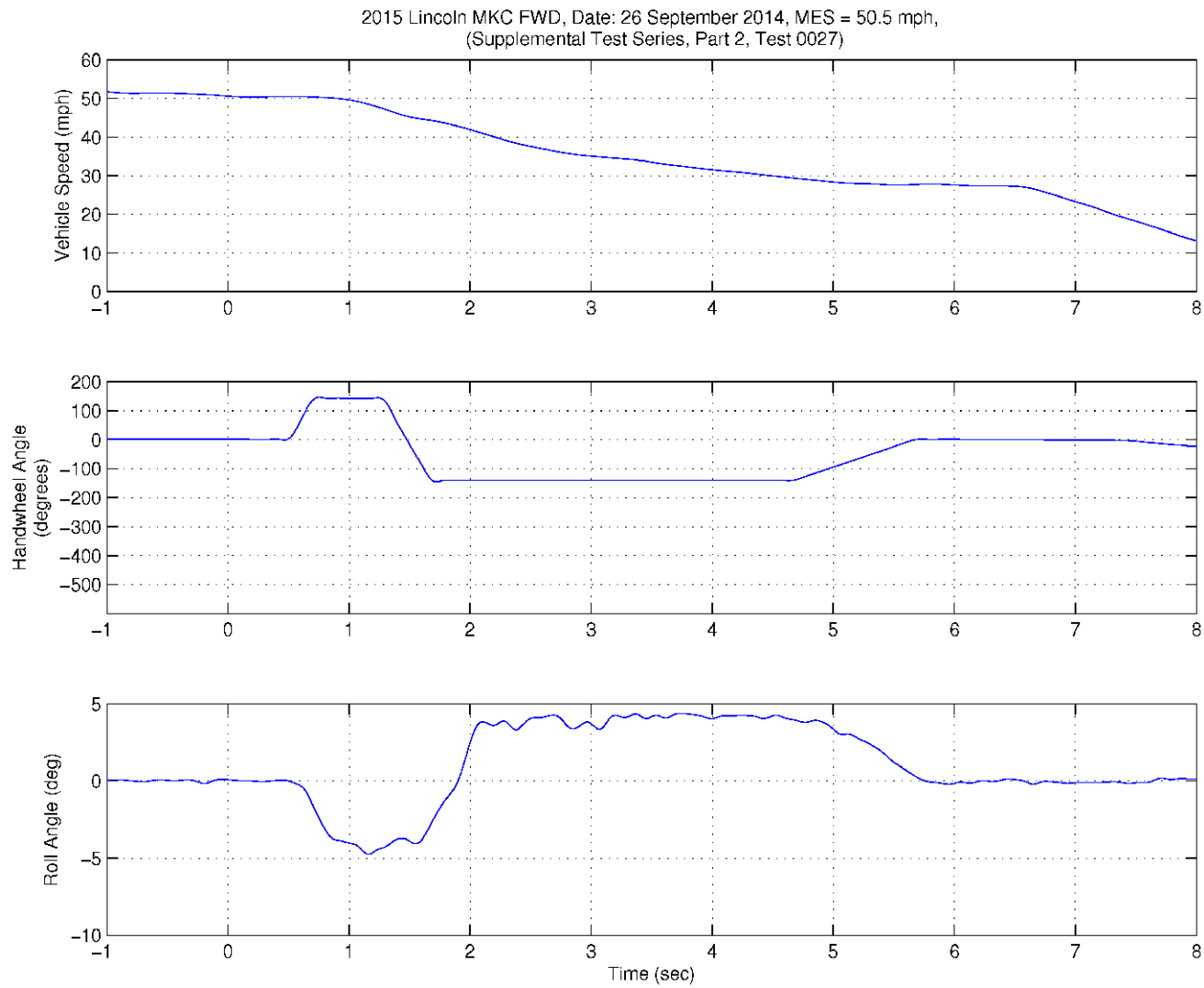

Figure D13. Vehicle Speed, Handwheel Angle, and Roll Angle Time History Plots for Supplemental 2 Test Series, R-L, 50 mph

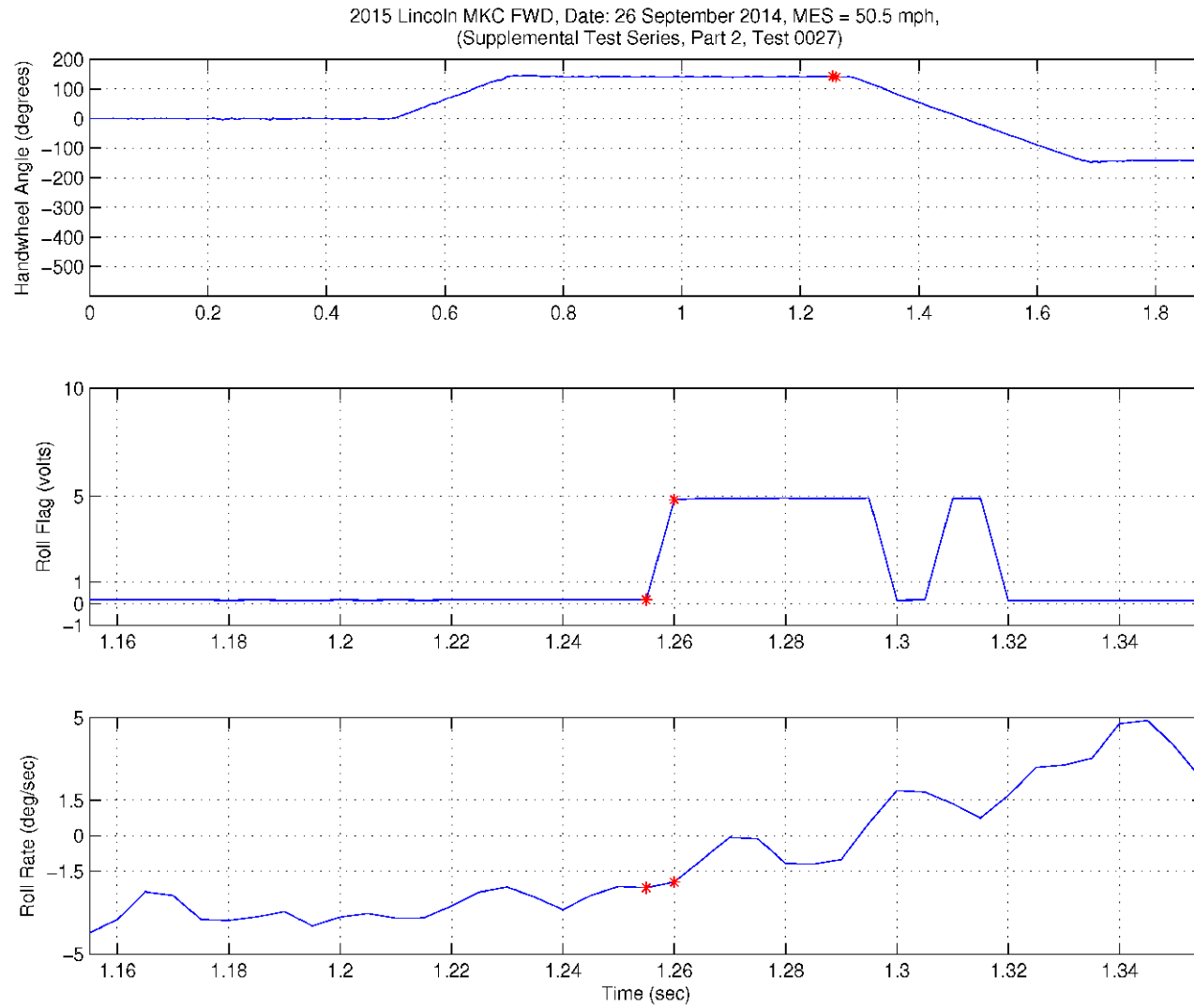

Figure D14. Steering Machine Operation Time History Plots for Supplemental 2 Test Series, R-L, 50 mph

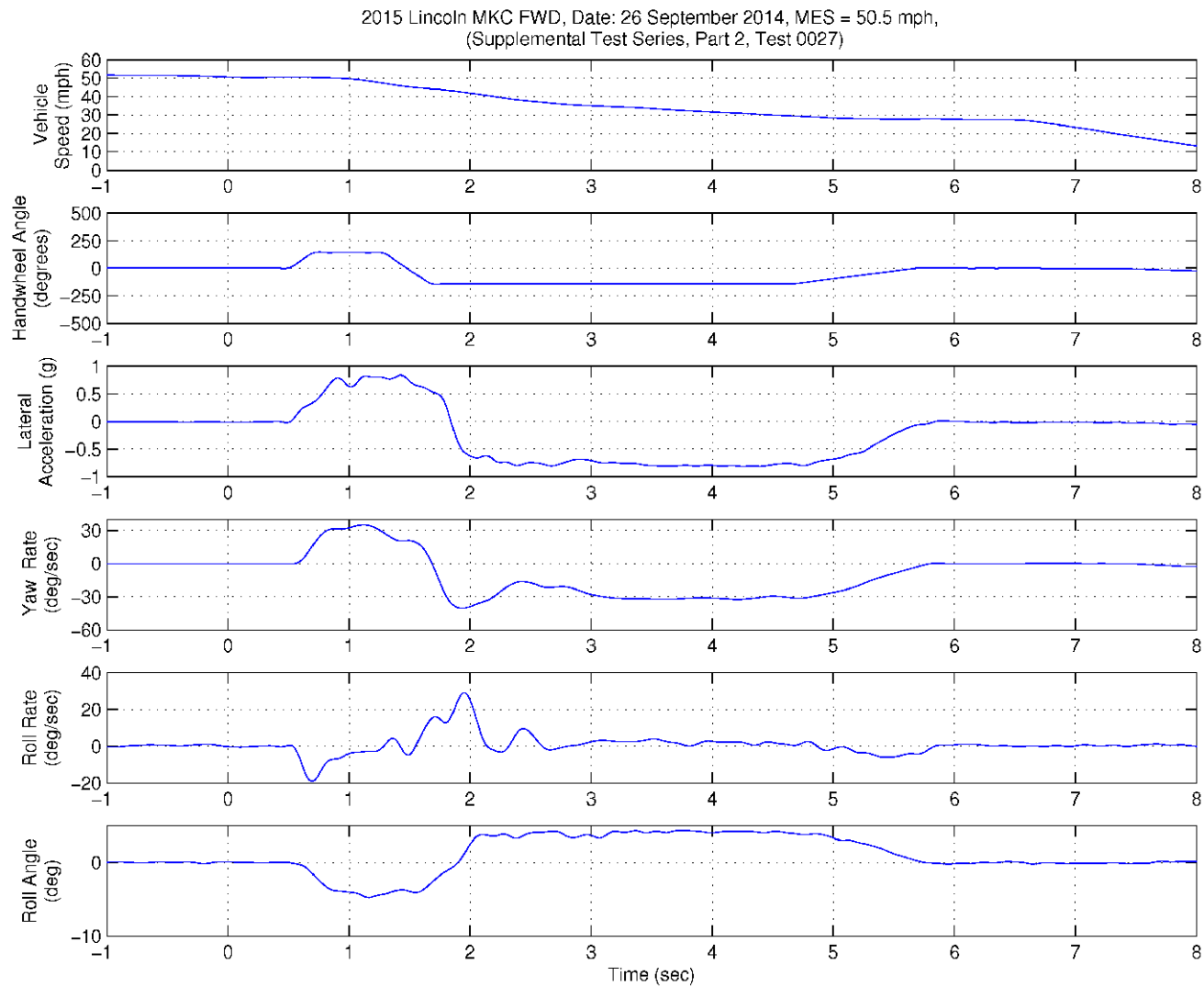

Figure D15. Yaw Rate, Roll Rate, and Lateral Acceleration Time History Plots for Supplemental 2 Test Series, R-L, 50 mph

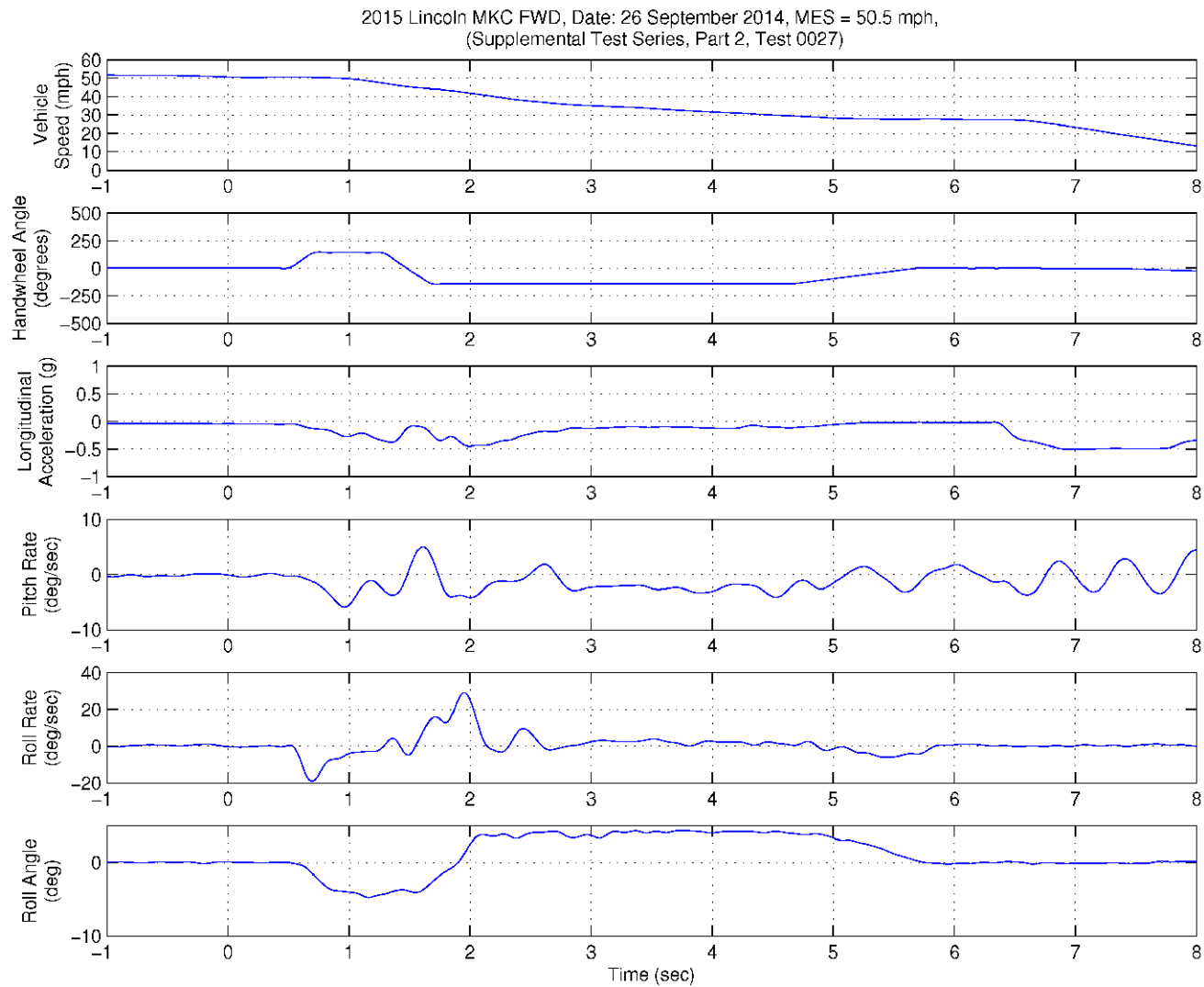

Figure D16. Pitch Rate and Longitudinal Acceleration Time History Plots for Supplemental 2 Test Series, R-L, 50 mph