

**NEW CAR ASSESSMENT PROGRAM (NCAP)
DYNAMIC ROLLOVER RESISTANCE TEST**

FCA US LLC

2017 Jeep Wrangler Unlimited 4WD

TEST NUMBER: 17-04

Final Report
17 January 2017



Prepared by:

Dynamic Research, Inc
355 Van Ness Ave. #200
Torrance, CA 90501

Prepared for:

National Highway Traffic Safety Administration
Office of Crash Avoidance Standards
1200 New Jersey Avenue S.E.
Washington, DC 20590

The United States Government assumes no liability for the contents of this report or use thereof. If trade or manufacturers' names or products are mentioned, it is only because they are considered essential to the object of the publication and should not be construed as an endorsement. The United States Government does not endorse products or manufacturers.

Dynamic Research, Inc. does not endorse or certify products of manufacturers. The manufacturer's name appears solely to identify the test article. Dynamic Research, Inc. assumes no liability for the report or use thereof. It is responsible for the facts and the accuracy of the data presented herein. This report does not constitute a standard, specification, or regulation.

Report Prepared by:



John Lenkeit, Program Manager

Date: 17 January 2017

Report Approved by:

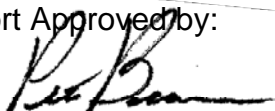

Peter Broen, Principal Engineer

Date: 17 January 2017

1. Report No. 17-04	2. Government Accession No.	3. Recipient's Catalog No.	
4. Title and Subtitle NCAP Dynamic Rollover Resistance Maneuver (Fishhook) Test of a 2017 Jeep Wrangler Unlimited 4WD MPV		5. Report Date 17 January 2017	6. Performing Organization Code DRI
		8. Performing Organization Report No. DRI- TM-16-200	
7. Author(s) John Lenkeit, Program Manager Peter Broen, Project Engineer		10. Work Unit No. (TRAIS)	
9. Performing Organization Name and Address Dynamic Research, Inc. 355 Van Ness Ave. #200 Torrance, CA 90501		11. Contract or Grant No. DTNH22-14-D-00332	
		13. Type of Report and Period Covered Final Report November 2016 to January 2017	
12. Sponsoring Agency Name and Address National Highway Traffic Safety Administration Office of Crash Avoidance Standards 1200 New Jersey Avenue S.E. Washington, DC 20590		14. Sponsoring Agency Code	
		15. Supplemental Notes	
16. Abstract An NCAP Dynamic Rollover Maneuver (Fishhook) Test was conducted on a 2017 Jeep Wrangler Unlimited 4WD at Dynamic Research, Inc. on November 22, 2016. The vehicle did not experience two-wheel lift. The vehicle's steering angle at 0.3g lateral acceleration at 50 mph was 42.5 degrees.			
17. Key Words NCAP Rollover Resistance Ratings Fishhook Test		18. Distribution Statement Copies of this report are available from: National Highway Traffic Safety Admin. Office of Crash Avoidance Standards 1200 New Jersey Ave., S.E., Room W43-461 Washington, DC 20590	
19. Security Classif. (of this report) Unclassified	20. Security Classif. (of this page) Unclassified	21. Number of Pages 50	22. Price

TABLE OF CONTENTS

	Page
I. INTRODUCTION.....	1
II. VEHICLE PREPARATION	2
A. Test Vehicle	2
B. Tires	2
C. Vehicle Loading.....	2
D. Steering Controller	5
E. Instrumentation and Data Collection	5
F. Other Vehicle Preparation	5
III. TEST PROCEDURES.....	8
A. Test Procedure Overview.....	8
B. Test Conditions	9
IV. RESULTS.....	12
APPENDIX A Photographs	A-1
APPENDIX B Test Run Log.....	B-1
APPENDIX C Slowly Increasing Steer Test Worksheet.....	C-1
APPENDIX D Time History Plots	D-1

LIST OF FIGURES

	Page
1. Nominal Position of Video Cameras for Fishhook Tests	8
2. DRI-Minter Vehicle Dynamics Area	12

LIST OF TABLES

	Page
1. Test Vehicle Data	3
2. Tire Information	4
3. Vehicle Loading	4
4. Sensors	7
5. Surface Friction	10
6. Handwheel Angles	11
7. Weather Conditions	11

Section I INTRODUCTION

Beginning with the 2006 fiscal year, the National Highway Traffic Safety Administration (NHTSA) has engaged Dynamic Research, Inc. (DRI) of Torrance, CA to conduct dynamic rollover testing and gather data from that testing as part of NHTSA's New Car Assessment Program (NCAP).

The purpose of the testing reported herein was to determine if a typical 2017 Jeep Wrangler Unlimited 4WD would experience tip-up, defined as simultaneous two-wheel lift of two inches or more at an entry speed of 50 mph or less in the Fishhook Procedure developed by NHTSA. This procedure may be found at www.regulations.gov, docket item NHTSA-2006-26555-0136.

The testing reported herein was accomplished under contract DTNH22-14-D-00332. The task order is entitled, "New Car Assessment Program (NCAP) Non-Destructive Vehicle Testing and Data Gathering."

Section II VEHICLE PREPARATION

A. TEST VEHICLE

The test vehicle was new or in as-new condition, meaning the vehicle had been driven no more than 500 miles prior to the start of dynamic rollover testing. It was acquired through a commercial rental/leasing company. Details of the test vehicle are given in Table 1.

B. TIRES

All tires used were new, and of the same make, model, size, and DOT specification of those installed on the vehicle when purchased new. Tire inflation pressures were in accordance with the recommendations indicated on each vehicle's identification placard. To reduce the possibility of tire debanding during Fishhook testing, an appropriately sized inner tube was installed in each tire. To further reduce the possibility of tire debanding, the tires were mounted to the rims without the use of tire mounting lubricant. Tire specifications are listed in Table 2.

C. VEHICLE LOADING

The multi-passenger load, described in the Fishhook Procedure, was used for all tests. The load and positioning of the load in the vehicle are listed in Table 3.

In addition to water dummies, the loading included instrumentation, a steering machine, and outriggers. Test vehicle bumper assemblies were removed for outrigger installation. The reduction in vehicle weight due to the removal of the bumpers was offset by the additional weight of the outriggers and their mounting system. The outrigger system typically outweighs the bumper assemblies.

Table 1. Test Vehicle Data

General Data					
Model year, make, model	2017 Jeep Wrangler Unlimited 4WD				
VIN	1C4BJWDG1HL51xxxx				
Body style	MPV				
Number of doors	4				
Trim level	A7X9				
Seating positions	Front:	2 nd row	3 rd row	4 th row	5 th row
	2	3	0	0	0
Electronic stability control	Yes				
4-Wheel ABS (Yes/No)	Yes				
Power steering (Yes/No)	Yes				
Major optional equipment	Connectivity Group 5spd Automatic Transmission Freedom Top Radio 430				
Odometer at start of testing	8 miles				
Drivetrain					
Engine cylinder arrangement	V-6				
Engine displacement	3.6 L				
Transmission type	Automatic				
Drive arrangement	4WD				
Chassis					
Track width	F: 62 in (1574.8 mm) , R: 62 in (1574.8 mm)				
Wheelbase	116 in (2946.4 mm)				
Curb weight	4343 lb (1970 kg)				
Certification Data from Vehicle's Label					
Vehicle manufactured by	FCA US LLC				
Date of manufacture	10/16				
GVWR	5400 lb (2450 kg)				
GAWR Front	2775 lb (1259 kg)				
GAWR Rear	3200 lb (1452 kg)				

Table 2. Tire Information

Tire Manufacturer	Goodyear
Tire Model	Wrangler ST
Tire Size	Front: 225/75R16 Rear: 225/75R16
Load rating	Front: 104 Rear: 104
Speed rating	Front: S Rear: S
Treadwear grade	Front: 340 Rear: 340
Traction grade	Front: B Rear: B
Temperature grade	Front: B Rear: B
Location of "Recommended Tire Pressure" label	
Recommended cold tire pressure	Front: 35 psi, (240 kPa) Rear: 35 psi, (240 kPa)
First 8 digits of DOT code	Front: M671 EYER Rear: M671 EYER

Table 3. Vehicle Loading

Water dummy and other loading	3 water dummies in second row
Water dummy weight	175 lb (79.4 kg)
Fuel level	Full
Weight as Tested	
Left front	1259 lb (571.1 kg)
Right front	1261 lb (572 kg)
Left rear	1385 lb (628.2 kg)
Right rear	1416 lb (642.3 kg)

D. STEERING CONTROLLER

A programmable steering machine was installed which generates handwheel steering inputs for all test maneuvers. The machine provides at least 35 lb-ft of torque at a handwheel rate of 720 deg/sec, is capable of actuating the vehicle's steering system through its full range, and accepts angular rate sensor feedback input for roll rate-induced steering reversals.

E. INSTRUMENTATION AND DATA COLLECTION

The test vehicle was instrumented with an angle encoder, located in the steering controller; a 3-axis inertial measurement unit to measure roll, pitch, and yaw rates, and longitudinal, lateral, and vertical acceleration; two ultrasonic distance measuring sensors to measure vehicle roll angle; and a radar speed sensor to measure vehicle speed. The brake light circuit was monitored to verify that there was no brake pedal application during any test.

A list of the sensors is given in Table 4. A 3B signal conditioning and power rack was used to provide any necessary sensor power, excitation, gain, and offset. Two pole Butterworth anti-alias filters were used for all analog data channels, using a corner frequency of 20 Hz. Data were collected at 200 samples/sec, using a Measurement Computing Corp. PCI-DAS6402/16 A/D board.

Two video cameras were used to record the Fishhook runs. They were positioned nominally as shown in Figure 1. The recorded videotapes were reviewed after the Fishhook runs to check for any two wheel lift. If any two wheel lift was observed, eight infrared distance measuring sensors for measurement of wheel lift (two sensors at each wheel) were then mounted for use in subsequent confirmation Fishhook tests.

F. OTHER VEHICLE PREPARATION

In addition to installation and preparation discussed above, the test vehicle was prepared as follows:

- Front and rear bumpers were removed
- Outrigger mounts were installed in the bumper locations and titanium outriggers were fastened to these mounts
- A five point safety harness was installed.
- Airbags were removed or otherwise disabled

Photographs of the vehicle tested are given in Appendix A.

Table 4. Sensors

Data Measured	Type	Range	Manufacturer	Model Number
Handwheel angle	Encoder	Infinite	Heitz Automotive Testing, Inc.	Angle encoder integral with steering controller
Brake pedal actuation	Tape Switch	On/Off	Vericom Computers	VC3000
Longitudinal, lateral, and vertical acceleration	Multi-axis inertial sensing system	± 2 g	BEI Technologies, Inc., Systron Donner Inertial Division	MP-1
Roll, pitch, and yaw rate		± 100 deg/s		
Left and right side vehicle ride height (to measure roll angle)	Ultrasonic distance measuring system	50 – 400 mm	Texense	RH550-400
Vehicle speed	Radar speed sensor	0 - 100 mph	Racelogic VBox	VBSS100-V3
Wheel lift (via resolution of two measured distances spaced a known distance apart), used for confirmation tests only	Analog displacement measuring system (Infrared; 880 mm)	13.8 - 33.5 in	Wenglor Sensors, Ltd.	HT 66MGV80

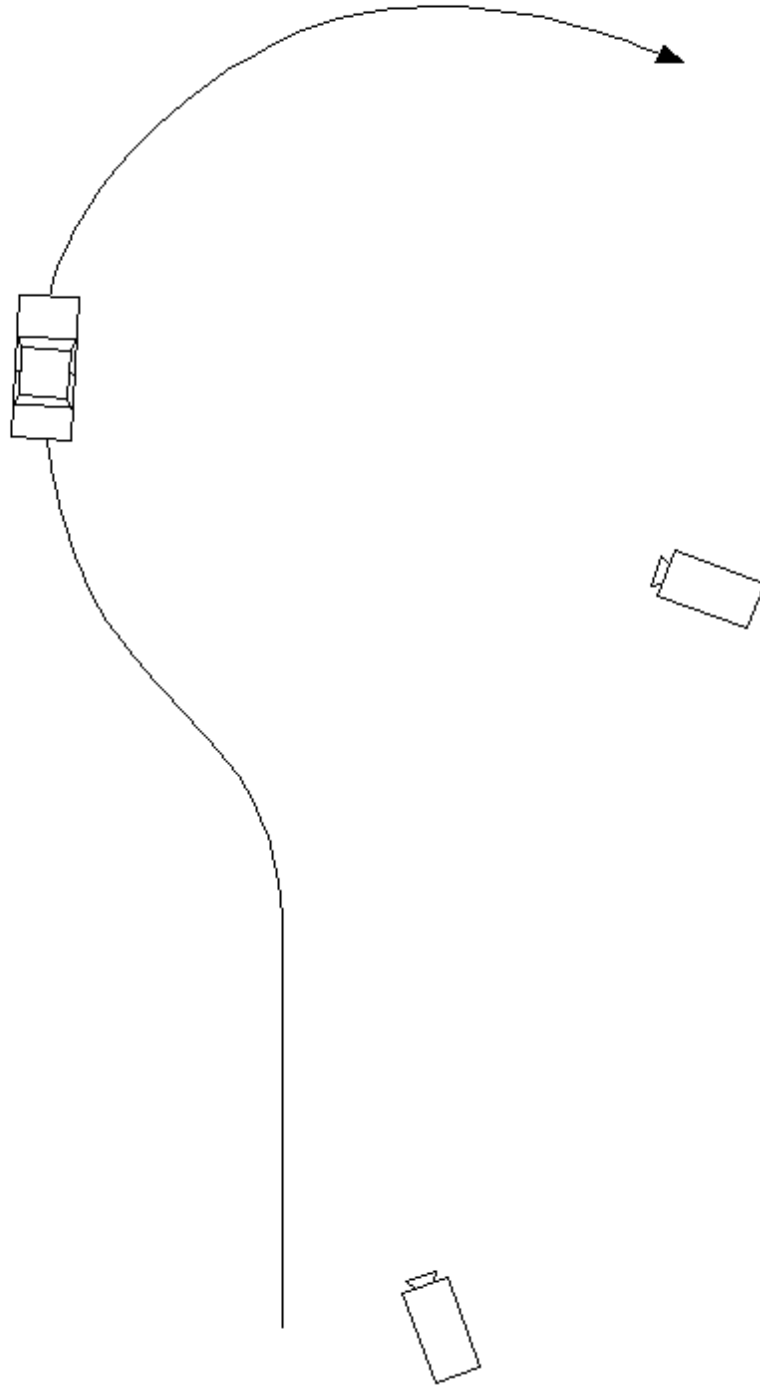

Figure 1. Nominal Position of Video Cameras for Fishhook Tests

Section III TEST PROCEDURES

This section includes a general overview of the test procedures and details of the particular test.

A. TEST PROCEDURE OVERVIEW

This test was conducted in accordance with NHTSA's NCAP Rollover Resistance Test Procedure (Fishhook) as described in the Federal Register (68 FR 59250). Detailed descriptions of the test procedure, pass/fail criteria, and data acquisition specifications may be found at docket NHTSA-2001-9663.

There are two major components of the test procedure, the Slowly Increasing Steer (SIS) pre-test and the Fishhook test.

The Slowly Increasing Steer (SIS) maneuver was used to characterize the steady state lateral dynamics of each vehicle, and is based on the "Constant Speed, Variable Steer" test defined in SAE J266. The maneuver is used to determine the handwheel angle that produces a lateral acceleration of 0.3 g at 50 mph. This handwheel angle is then used to determine the magnitude of steering to be used for the NHTSA Fishhook maneuver.

SIS tests were performed at a constant speed of 50 mph. Handwheel angle was input at a rate of 13.5 deg/sec, from 0 to an angle that provided at least 0.55 g. Three tests were conducted in each direction, and the data for the six runs were averaged to obtain the handwheel angle that produced 0.3 g at 50 mph.

The Fishhook test is a programmed steering maneuver that is implemented via the steering controller. The vehicle was initially steered in one direction and then the steering was reversed. The timing, magnitude and rate of the steering were prescribed by the Fishhook Procedure.

To begin the maneuver, the vehicle was driven in a straight line at a speed slightly greater than the desired entrance speed. The driver then released the throttle. When the vehicle was at the target speed, the steering controller automatically initiated the steering maneuver. Following completion of the steering reversal the handwheel position was maintained for three seconds, and then returned to zero angle in 1 second.

The tests were conducted in both left-right and right-left directions. The “Default” test series used a handwheel angle equal to 6.5 times the handwheel angle that produced 0.3 g at 50 mph in the SIS tests, and initial vehicle speeds beginning at 35 mph and concluding up to 50 mph (if no two-wheel lift occurs). Supplemental tests were also done, as specified in the Fishhook Procedure.

B. TEST CONDITIONS

1. Test Surface

The tests were conducted on the Vehicle Dynamics Area at DRI’s Minter Field facility, located near Bakersfield, California, on 11/22/2016. The VDA has a smooth, flat (slope less than 0.5% throughout) asphaltic concrete surface. Its dimensions are as shown in Figure 2. It was built in the spring of 2005.

VDA surface friction measurements were accomplished using the DRI Mobile Tire Tester. Three runs were done, one at each of three previously determined locations. Each run provided for a minimum of 3 seconds of tire friction at constant normal load, slip angle, and speed in a free rolling condition. The test was accomplished using an ASTM E1136 tire with an inflation pressure of 35 (± 0.5) psi at a test speed of 40 (± 0.5) mph. The net slip angle of the test tire for each test run was 7.5 deg. The test tire was no older than 6 months from the date of manufacture. The surface friction measurement results are shown in Table 5.

Table 5. Surface Friction

Date of surface friction measurements	11/22/2016
Average normalized lateral force	0.938

2. Fishhook Handwheel Angles

The 0.3g handwheel angle obtained from the SIS tests and the handwheel angles used in the Fishhook tests are shown in Table 6.

Table 6. Handwheel Angles

0.3g handwheel angle (from SIS tests at 50 mph)	42.5 °
5.5 scalar handwheel angle for Fishhook Test	234°
6.5 scalar handwheel angle for Fishhook Test	276 °

3. Weather Conditions

The weather conditions, recorded at the end of testing, are shown in Table 7.

Table 7. Weather Conditions

Ambient temperature	43 °F (6.1 °C)
Wind Speed	0 mph (0 m/s)
Wind Direction	

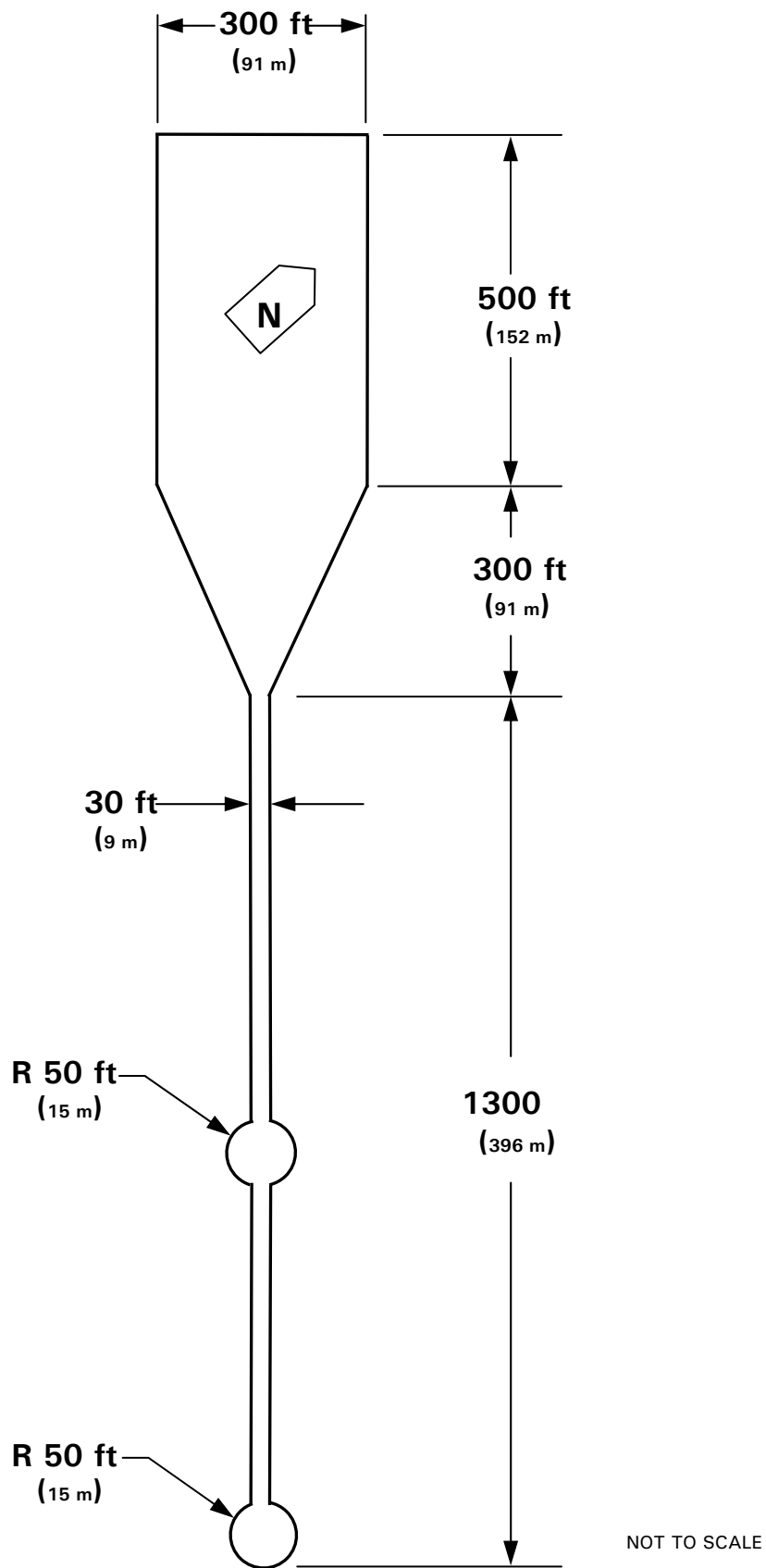

Figure 2. DRI-Minter Vehicle Dynamics Area

Section IV RESULTS

The test run log is given in Appendix B. The Slowly Increasing Steer Test Worksheet is given in Appendix C. Appendix D contains time history plots for the 50 mph runs and any runs which resulted in two-wheel lift. For the 2017 Jeep Wrangler Unlimited 4WD, there was no two-wheel lift at any test condition.

APPENDIX A

Photographs

LIST OF FIGURES

	Page
A1. Window Sticker.....	A-3
A2. Front View, Test Vehicle as Delivered	A-4
A3. Rear View, Test Vehicle as Delivered	A-5
A4. Front View, Test Vehicle in Test Condition.....	A-6
A5. Rear View, Test Vehicle in Test Condition	A-7
A6. Instrumentation in Test Vehicle	A-8
A7. Ballast Condition.....	A-9

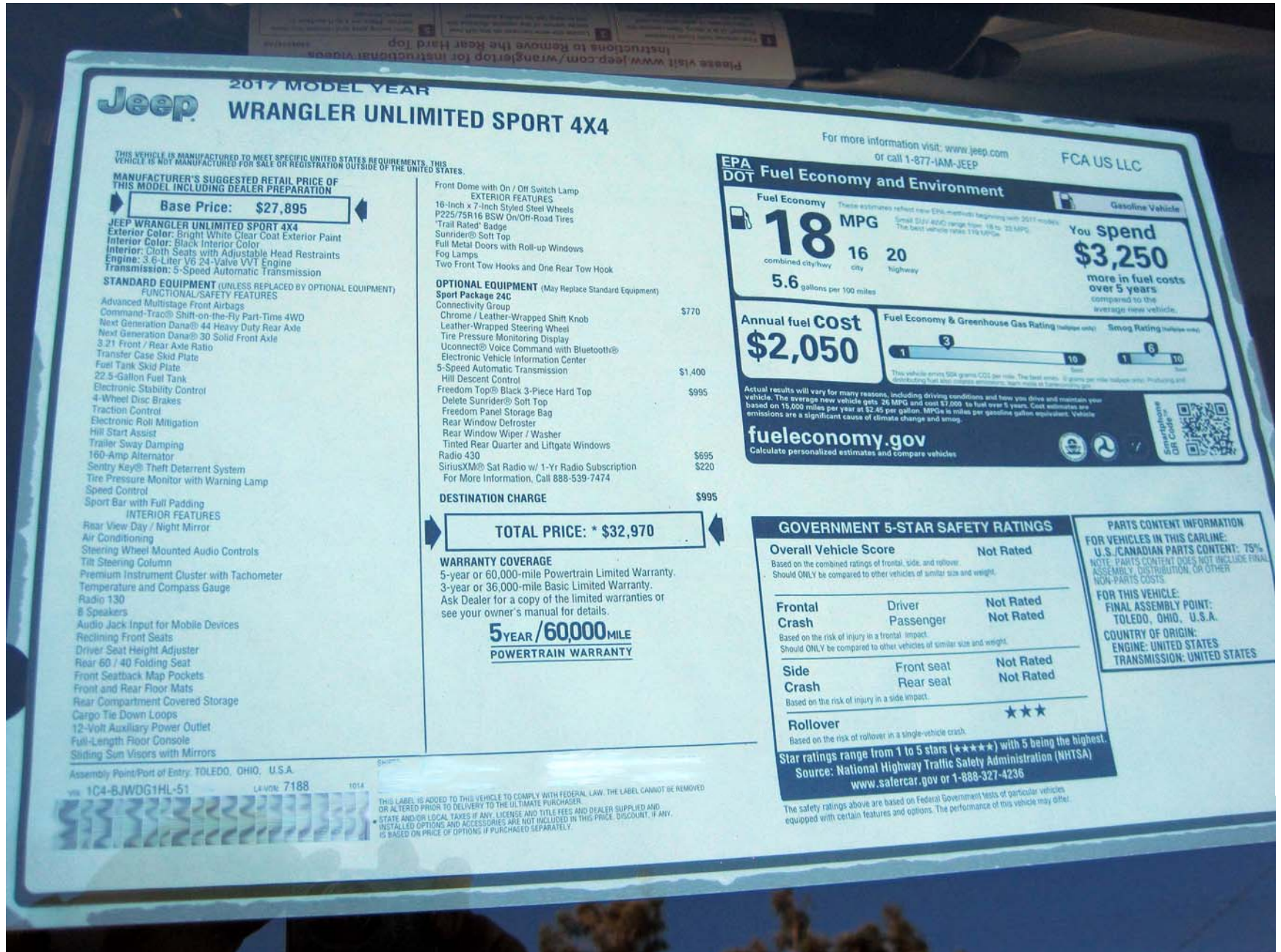

Jeep 2017 MODEL YEAR
WRANGLER UNLIMITED SPORT 4X4

THIS VEHICLE IS MANUFACTURED TO MEET SPECIFIC UNITED STATES REQUIREMENTS. THIS VEHICLE IS NOT MANUFACTURED FOR SALE OR REGISTRATION OUTSIDE OF THE UNITED STATES.

MANUFACTURER'S SUGGESTED RETAIL PRICE OF THIS MODEL INCLUDING DEALER PREPARATION

Base Price: \$27,895

JEEP WRANGLER UNLIMITED SPORT 4X4
Exterior Color: Bright White Clear Coat Exterior Paint
Interior Color: Black Interior Color
Interior: Cloth Seats with Adjustable Head Restraints
Engine: 3.6-Liter V6 24-Valve VVT Engine
Transmission: 5-Speed Automatic Transmission

STANDARD EQUIPMENT (UNLESS REPLACED BY OPTIONAL EQUIPMENT)
FUNCTIONAL SAFETY FEATURES

- Advanced Multistage Front Airbags
- Command-Trac® Shift-on-the-Fly Part-Time 4WD
- Next Generation Dana® 44 Heavy Duty Rear Axle
- Next Generation Dana® 30 Solid Front Axle
- 3.21 Front / Rear Axle Ratio
- Transfer Case Skid Plate
- Fuel Tank Skid Plate
- 22.9-Gallon Fuel Tank
- Electronic Stability Control
- 4-Wheel Disc Brakes
- Traction Control
- Electronic Roll Mitigation
- Hill Start Assist
- Trailer Sway Damping
- 160-Amp Alternator
- Sentry Key® Theft Deterrent System
- Tire Pressure Monitor with Warning Lamp
- Speed Control
- Sport Bar with Full Paddling

INTERIOR FEATURES

- Rear View Day / Night Mirror
- Air Conditioning
- Steering Wheel Mounted Audio Controls
- Tilt Steering Column
- Premium Instrument Cluster with Tachometer
- Temperature and Compass Gauge
- Radio 130
- 8 Speakers
- Audio Jack Input for Mobile Devices
- Reclining Front Seats
- Driver Seat Height Adjuster
- Rear 60 / 40 Folding Seat
- Front Seatback Map Pockets
- Front and Rear Floor Mats
- Rear Compartment Covered Storage
- Cargo Tie Down Loops
- 12-Volt Auxiliary Power Outlet
- Full-Length Floor Console
- Sliding Sun Visors with Mirrors

- Front Dome with On / Off Switch Lamp
- EXTERIOR FEATURES
- 16-inch x 7-inch Styled Steel Wheels
- P225/75R16 BSW On/Off-Road Tires
- Trail Rated® Badge
- Sunrider® Soft Top
- Full Metal Doors with Roll-up Windows
- Fog Lamps
- Two Front Tow Hooks and One Rear Tow Hook

OPTIONAL EQUIPMENT (May Replace Standard Equipment)

- Sport Package 24C** \$770
 - Connectivity Group
 - Chrome / Leather-Wrapped Shift Knob
 - Leather-Wrapped Steering Wheel
 - Tire Pressure Monitoring Display
 - Uconnect® Voice Command with Bluetooth®
 - Electronic Vehicle Information Center
- Hill Descent Control** \$1,400
- Freedom Top® Black 3-Piece Hard Top** \$995
 - Delete Sunrider® Soft Top
 - Freedom Panel Storage Bag
 - Rear Window Defroster
 - Rear Window Wiper / Washer
 - Tinted Rear Quarter and Liftgate Windows
- Radio 430** \$695
- SiriusXM® Sat Radio w/ 1-Yr Radio Subscription** \$220

DESTINATION CHARGE \$995

TOTAL PRICE: * \$32,970

WARRANTY COVERAGE
5-year or 60,000-mile Powertrain Limited Warranty.
3-year or 36,000-mile Basic Limited Warranty.
Ask Dealer for a copy of the limited warranties or see your owner's manual for details.

5 YEAR / 60,000 MILE
POWERTRAIN WARRANTY

Assembly Plant/Port of Entry: TOLEDO, OHIO, U.S.A.
VIN: 1C4BJWDG1HL-51 L4V06 7188 1014

THIS LABEL IS ADDED TO THIS VEHICLE TO COMPLY WITH FEDERAL LAW. THE LABEL CANNOT BE REMOVED OR ALTERED PRIOR TO DELIVERY TO THE ULTIMATE PURCHASER.
* STATE AND/OR LOCAL TAXES IF ANY, LICENSE AND TITLE FEES AND DEALER SUPPLIED AND INSTALLED OPTIONS AND ACCESSORIES ARE NOT INCLUDED IN THIS PRICE. DISCOUNT, IF ANY, IS BASED ON PRICE OF OPTIONS IF PURCHASED SEPARATELY.

For more information visit: www.jeep.com or call 1-877-IAM-JEEP

FCA US LLC

EPA DOT Fuel Economy and Environment

Fuel Economy These estimates reflect new EPA methods beginning with 2017 models. Small SUV 4WD range from 18 to 23 MPG. The best vehicle rates 119 MPG.

18 MPG combined city/hwy
16 city
20 highway
5.6 gallons per 100 miles

Gasoline Vehicle

You spend \$3,250 more in fuel costs over 5 years compared to the average new vehicle.

Annual fuel Cost \$2,050

Fuel Economy & Greenhouse Gas Rating (multiple only) 1 3 10 10
This vehicle emits 504 grams CO2 per mile. The best emits 16 grams per mile (sedan only). Producing and refining fuel also create emissions. Learn more at fuel-economy.gov

Smog Rating (multiple only) 1 6 10

Actual results will vary for many reasons, including driving conditions and how you drive and maintain your vehicle. The average new vehicle gets 26 MPG and cost \$2,000 to fuel over 5 years. Cost estimates are based on 15,000 miles per year at \$2.45 per gallon. MPG is miles per gallon. Vehicle emissions are a significant cause of climate change and smog.

fuel-economy.gov
Calculate personalized estimates and compare vehicles

Smartphone QR Code

GOVERNMENT 5-STAR SAFETY RATINGS

Overall Vehicle Score Not Rated
Based on the combined ratings of frontal, side, and rollover. Should ONLY be compared to other vehicles of similar size and weight.

Frontal Crash	Driver Passenger	Not Rated Not Rated
Based on the risk of injury in a frontal impact. Should ONLY be compared to other vehicles of similar size and weight.		
Side Crash	Front seat Rear seat	Not Rated Not Rated
Based on the risk of injury in a side impact.		
Rollover		★★★
Based on the risk of rollover in a single-vehicle crash.		

Star ratings range from 1 to 5 stars (★★★★★) with 5 being the highest.
Source: National Highway Traffic Safety Administration (NHTSA)
www.safercar.gov or 1-888-327-4236

The safety ratings above are based on Federal Government tests of particular vehicles equipped with certain features and options. The performance of this vehicle may differ.

PARTS CONTENT INFORMATION
FOR VEHICLES IN THIS CARLINE:
U.S./CANADIAN PARTS CONTENT: 75%
NOTE: PARTS CONTENT DOES NOT INCLUDE FINAL ASSEMBLY, DISTRIBUTION, OR OTHER NON-PARTS COSTS.
FOR THIS VEHICLE:
FINAL ASSEMBLY POINT:
TOLEDO, OHIO, U.S.A.
COUNTRY OF ORIGIN:
ENGINE: UNITED STATES
TRANSMISSION: UNITED STATES

Figure A1. Window Sticker



Figure A2. Front View, Test Vehicle as Delivered



Figure A3. Rear View, Test Vehicle as Delivered



Figure A4. Front View, Test Vehicle in Test Condition



Figure A5. Rear View, Test Vehicle in Test Condition



Figure A6. Instrumentation in Test Vehicle

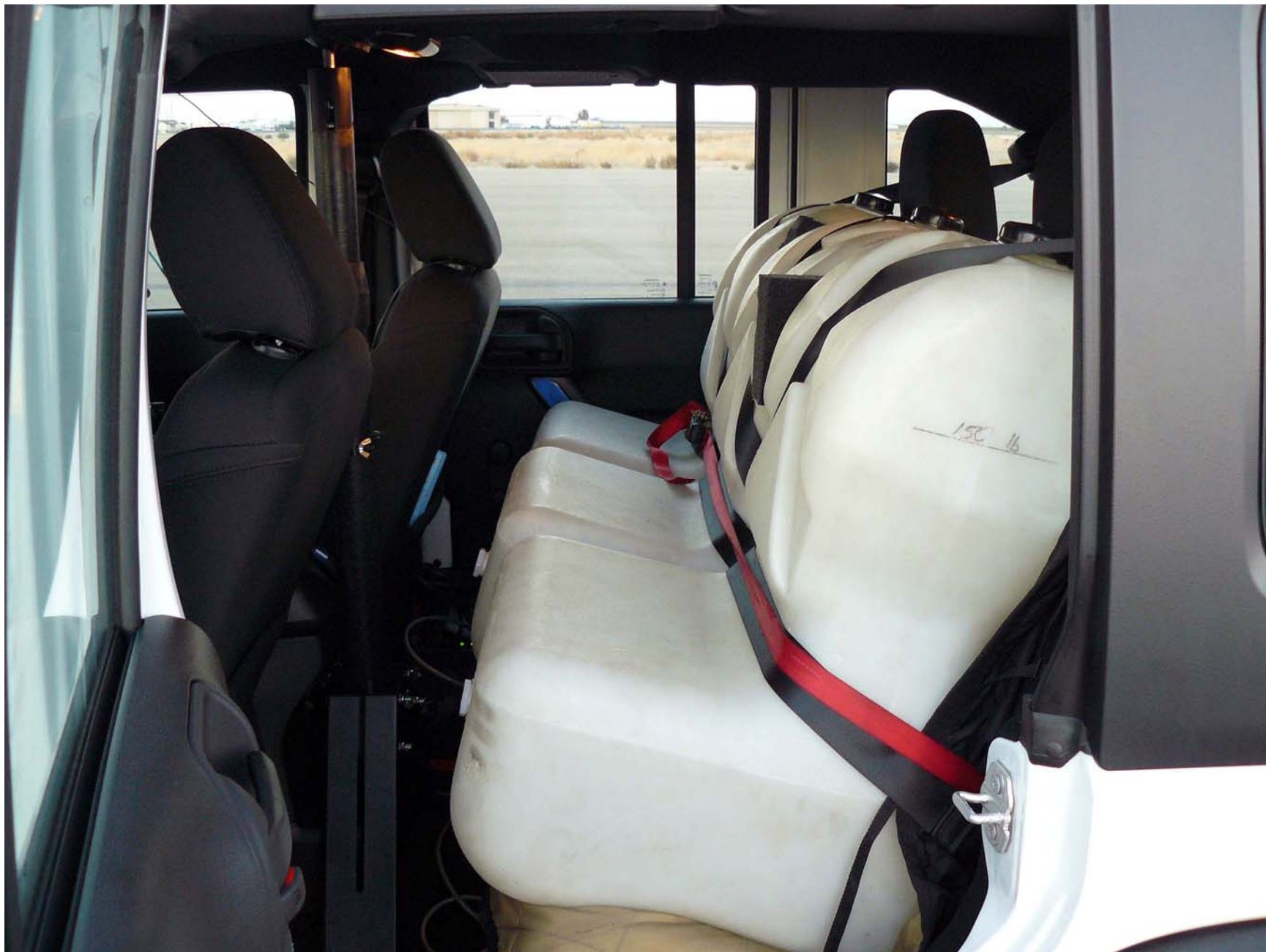

Figure A7. Ballast Condition

APPENDIX B

Test Run Log

Vehicle: **2017 Jeep Wrangler
Unlimited 4WD**

Driver: **Stephan Rhim**

Date: **11/22/2016**

Run Number	Test Type	Speed (mph)	Handwheel Angle (deg)	Dir. of First Steer	2 Wheel Lift	Notes
1	Tire Warm-Up	35	100	Right	5P	Resulted in ay = 0.65g
2			80			Resulted in ay = 0.57g
3						
4						
5						2x SWA last cycle
6	Static	0	0			
7	Steady State	50	0			
8	Slowly Increasing Steer	50	40	Left	NA	Resulted in ay = 0.36g
9	Slowly Increasing Steer	50	60	Left	NA	Resulted in ay = 0.5g
10	Slowly Increasing Steer	50	60	Left	NA	
11	Slowly Increasing Steer	50	60	Left	NA	
12	Slowly Increasing Steer	50	60	Right	NA	
13	Slowly Increasing Steer	50	60	Right	NA	
14	Slowly Increasing Steer	50	60	Right	NA	
15	Fishhook	35	276	Left	No	6.5 Scalar No rear video
16	Fishhook	35	276	Left	No	
17	Fishhook	40	276	Left	No	
18	Fishhook	45	276	Left	No	
19	Fishhook	47.5	276	Left	No	
20	Fishhook	50	276	Left	No	
21	Fishhook	35	276	Right	No	
22	Fishhook	40	276	Right	No	
23	Fishhook	45	276	Right	No	
24	Fishhook	47.5	276	Right	No	
25	Fishhook	50	276	Right	No	

Vehicle: **2017 Jeep Wrangler
Unlimited 4WD**

Driver: **Stephan Rhim**

Date: **11/22/2016**

Run Number	Test Type	Speed (mph)	Handwheel Angle (deg)	Dir. of First Steer	2 Wheel Lift	Notes
					No	
26	Fishhook	45		Right	No	5.5 Scalar, NG Incorrect angle set
27	Fishhook	45	234	Right	No	
28	Fishhook	47.5	234	Right	No	
29	Fishhook	50	234	Right	No	
30	Fishhook	45	234	Left	No	
31	Fishhook	47.5	234	Left	No	ng
32	Fishhook	47.5	234	Left	No	
33	Fishhook	50	234	Left	No	

APPENDIX C

Slowly Increasing Steer Test Worksheet

NCAP, 2017 Jeep Wrangler Unlimited 4WD , Multi-Passenger Load, Test Date: 11/22/2016

SIS_out_v2

Run	Dir of Steer	Start Speed (mph)	End Speed (mph)	Speed Red. (%)	Index of ay @ 0.3g	HW Angle (deg) at 0.3g	ay (g) @ 0.3g index	6.5x HW Angle (deg)	Ramp Time (sec) at 6.5x	5.5x HW Angle (deg)	Ramp Time (sec) at 5.5x	R2	Zero Begin Index	Zero End Index
9	1	49.3	0.7	98.7	1160	-44.5	-0.282	-289.0	-0.4015	-244.6	-0.3397	0.9747	300	500
10	1	49.7	6.6	86.7	1145	-43.5	-0.308	-282.8	-0.3928	-239.3	-0.3323	0.9940	300	500
11	1	49.7	1.2	97.5	1157	-44.2	-0.303	-287.1	-0.3988	-242.9	-0.3374	0.9968	300	500
12	0	50.0	6.7	86.6	1096	40.2	0.296	261.2	0.3628	221.0	0.3070	0.9954	300	500
13	0	49.3	10.6	78.6	1120	41.8	0.302	271.6	0.3772	229.8	0.3192	0.9901	300	500
14	0	49.3	0.8	98.4	1106	40.8	0.297	265.5	0.3687	224.6	0.3120	0.9924	300	500

Mean: 42.5 0.298 276 0.384 234 0.325

Steering Controller Input Values

Scalar 6.5 values:

Initial HW angle: 276 deg
Initial time: 0.384 s
Reversal HW angle: -276 deg
Reversal time: 0.767 s

Scalar 5.5 values:

Initial HW angle: 234 deg
Initial time: 0.325 s
Reversal HW angle: -234 deg
Reversal time: 0.649 s

APPENDIX D

Time History Plots

LIST OF FIGURES

	Page
D1. Vehicle Speed, Handwheel Angle, and Roll Angle Time History Plots for Default Test Series, L-R, 50 mph	D-3
D2. Steering Machine Operation Time History Plots for Default Test Series, L-R, 50 mph.....	D-4
D3. Yaw Rate, Roll Rate, and Lateral Acceleration Time History Plots for Default Test Series, L-R, 50 mph	D-5
D4. Pitch Rate and Longitudinal Acceleration Time History Plots for Default Test Series, L-R, 50 mph	D-6
D5. Vehicle Speed, Handwheel Angle, and Roll Angle Time History Plots for Default Test Series, R-L, 50 mph	D-7
D6. Steering Machine Operation Time History Plots for Default Test Series, R-L, 50 mph	D-8
D7. Yaw Rate, Roll Rate, and Lateral Acceleration Time History Plots for Default Test Series, R-L, 50 mph	D-9
D8. Pitch Rate and Longitudinal Acceleration Time History Plots for Default Test Series, R-L, 50 mph	D-10
D9. Vehicle Speed, Handwheel Angle, and Roll Angle Time History Plots for Supplemental 2 Test Series, L-R, 50 mph.....	D-11
D10. Steering Machine Operation Time History Plots for Supplemental 2 Test Series, L-R, 50 mph.....	D-12
D11. Yaw Rate, Roll Rate, and Lateral Acceleration Time History Plots for Supplemental 2 Test Series, L-R, 50 mph.....	D-13
D12. Pitch Rate and Longitudinal Acceleration Time History Plots for Supplemental 2 Test Series, L-R, 50 mph.....	D-14
D13. Vehicle Speed, Handwheel Angle, and Roll Angle Time History Plots for Supplemental 2 Test Series, R-L, 50 mph.....	D-15
D14. Steering Machine Operation Time History Plots for Supplemental 2 Test Series, R-L, 50 mph.....	D-16
D15. Yaw Rate, Roll Rate, and Lateral Acceleration Time History Plots for Supplemental 2 Test Series, R-L, 50 mph.....	D-17
D16. Pitch Rate and Longitudinal Acceleration Time History Plots for Supplemental 2 Test Series, R-L, 50 mph.....	D-18

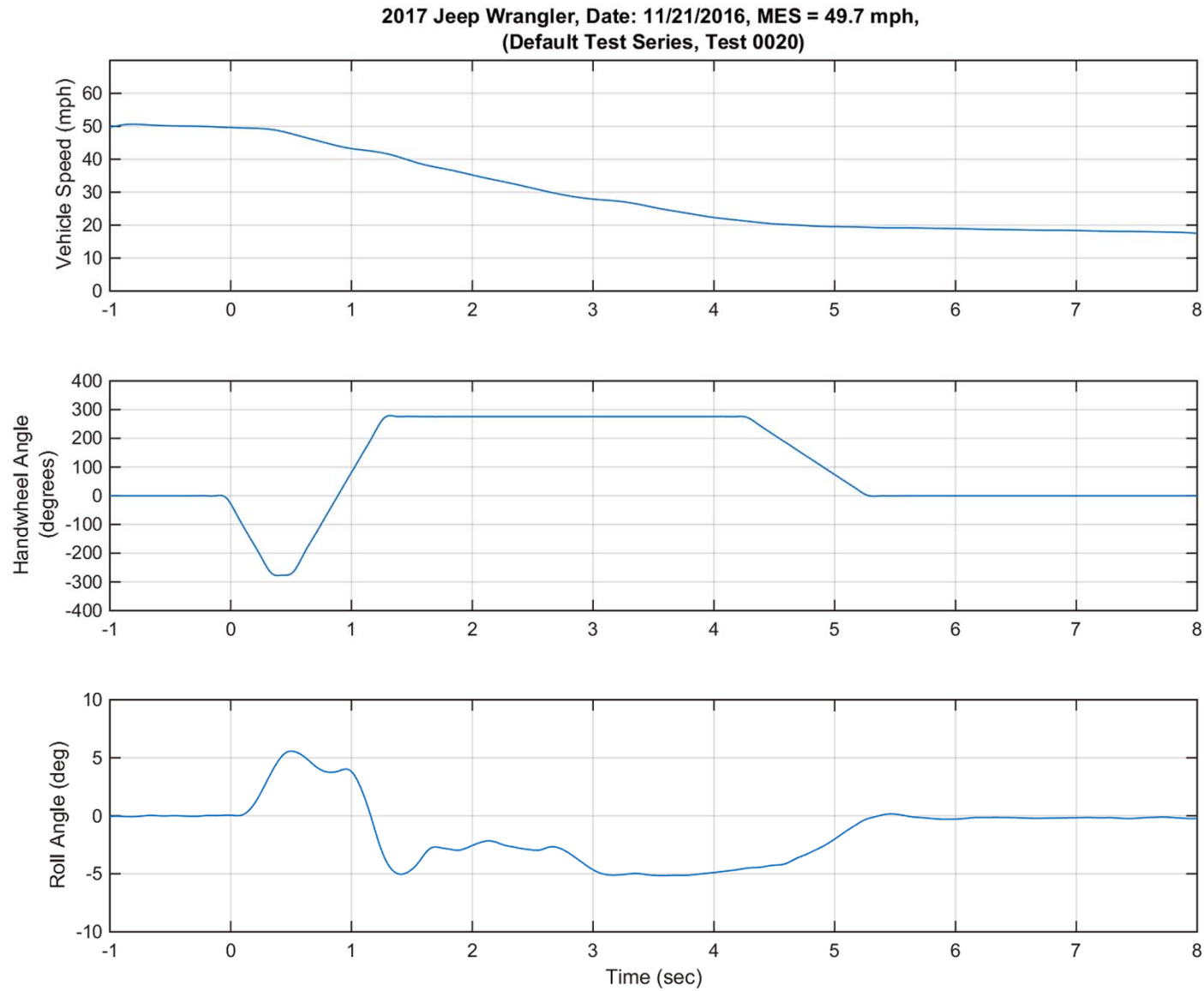

Figure D1. Vehicle Speed, Handwheel Angle, and Roll Angle Time History Plots for Default Test Series, L-R, 50 mph

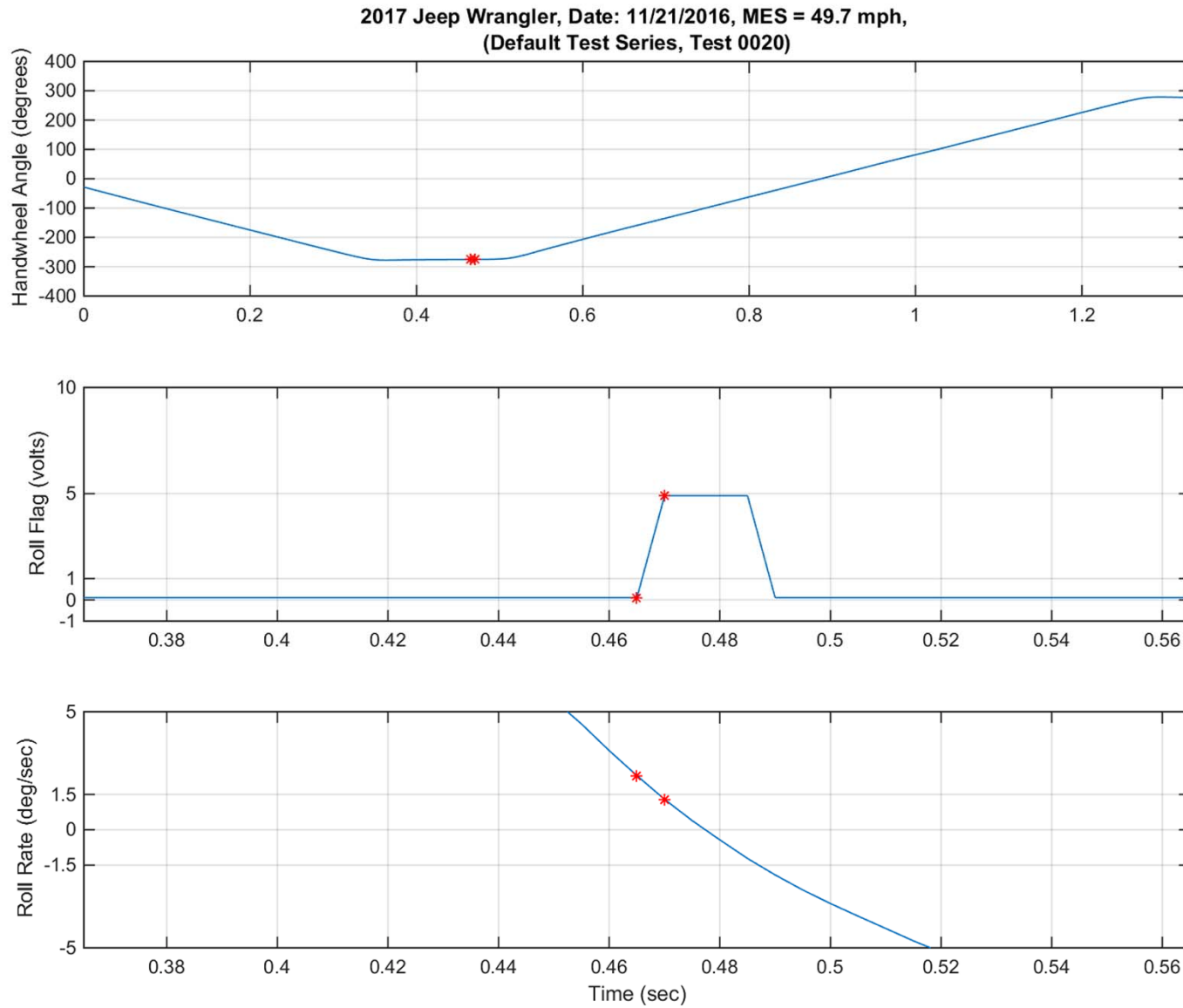

Figure D2. Steering Machine Operation Time History Plots for Default Test Series, L-R, 50 mph

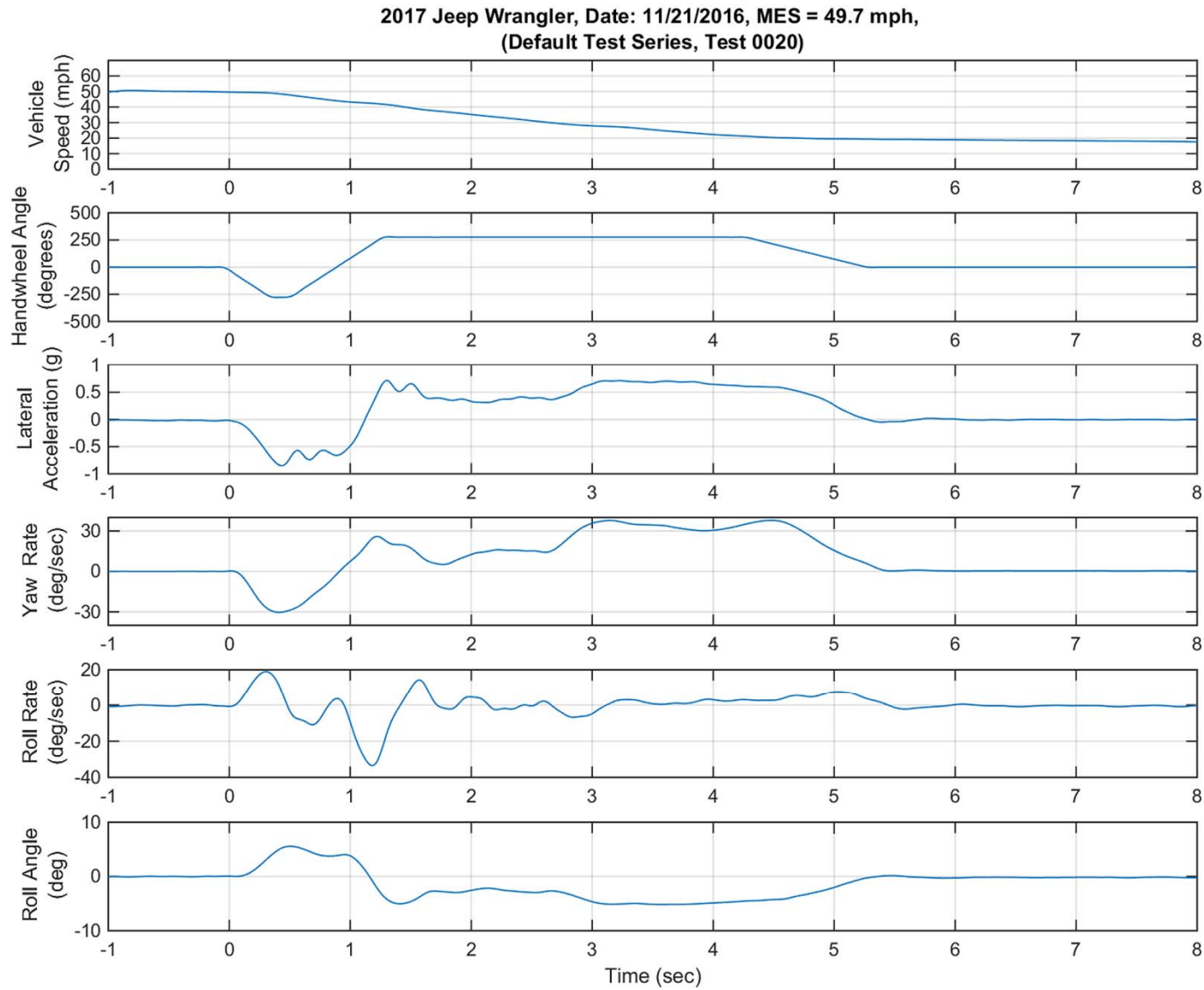

Figure D3. Yaw Rate, Roll Rate, and Lateral Acceleration Time History Plots For Default Test Series, L-R, 50 mph

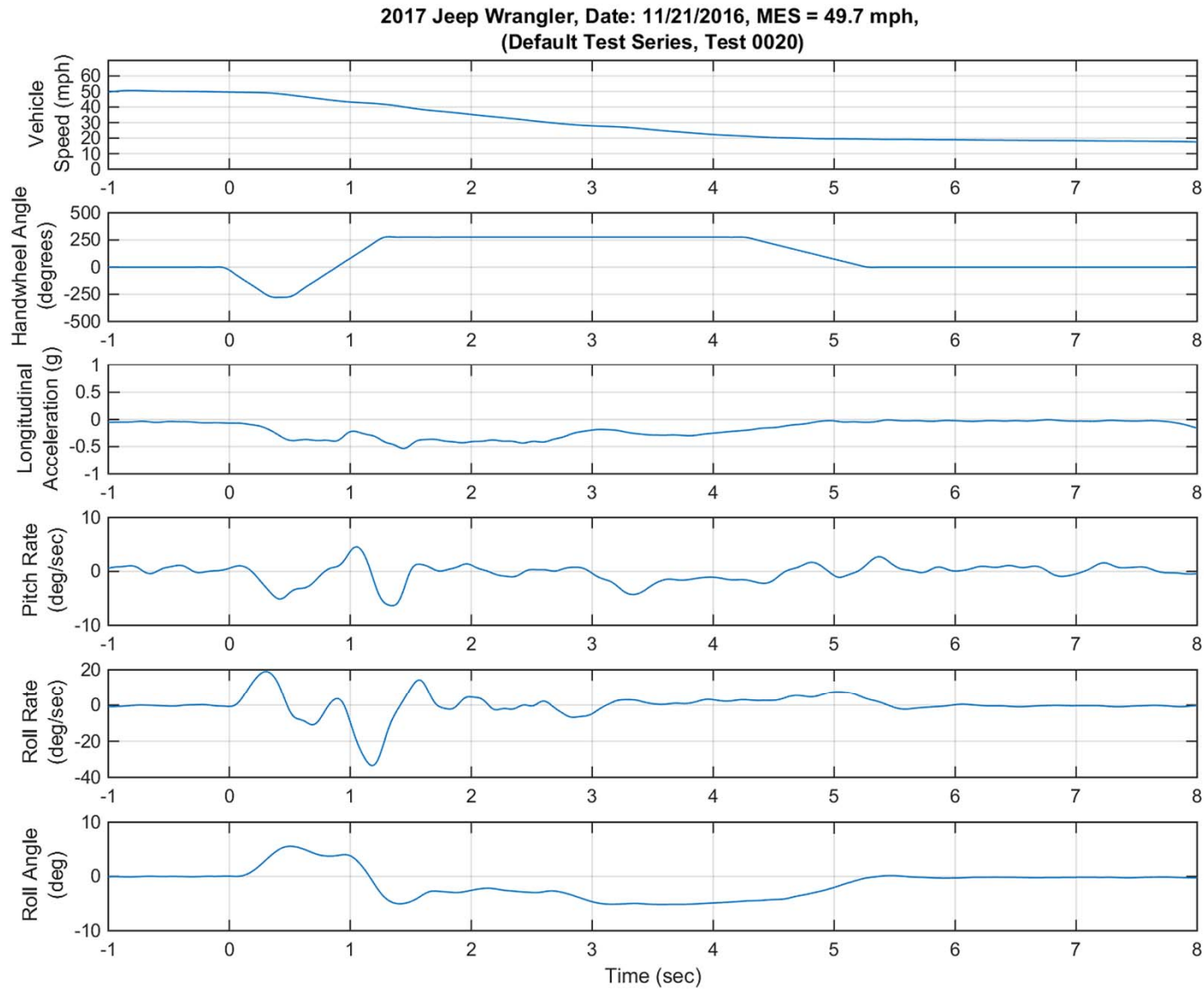

Figure D4. Pitch Rate and Longitudinal Acceleration Time History Plots for Default Test Series, L-R, 50 mph

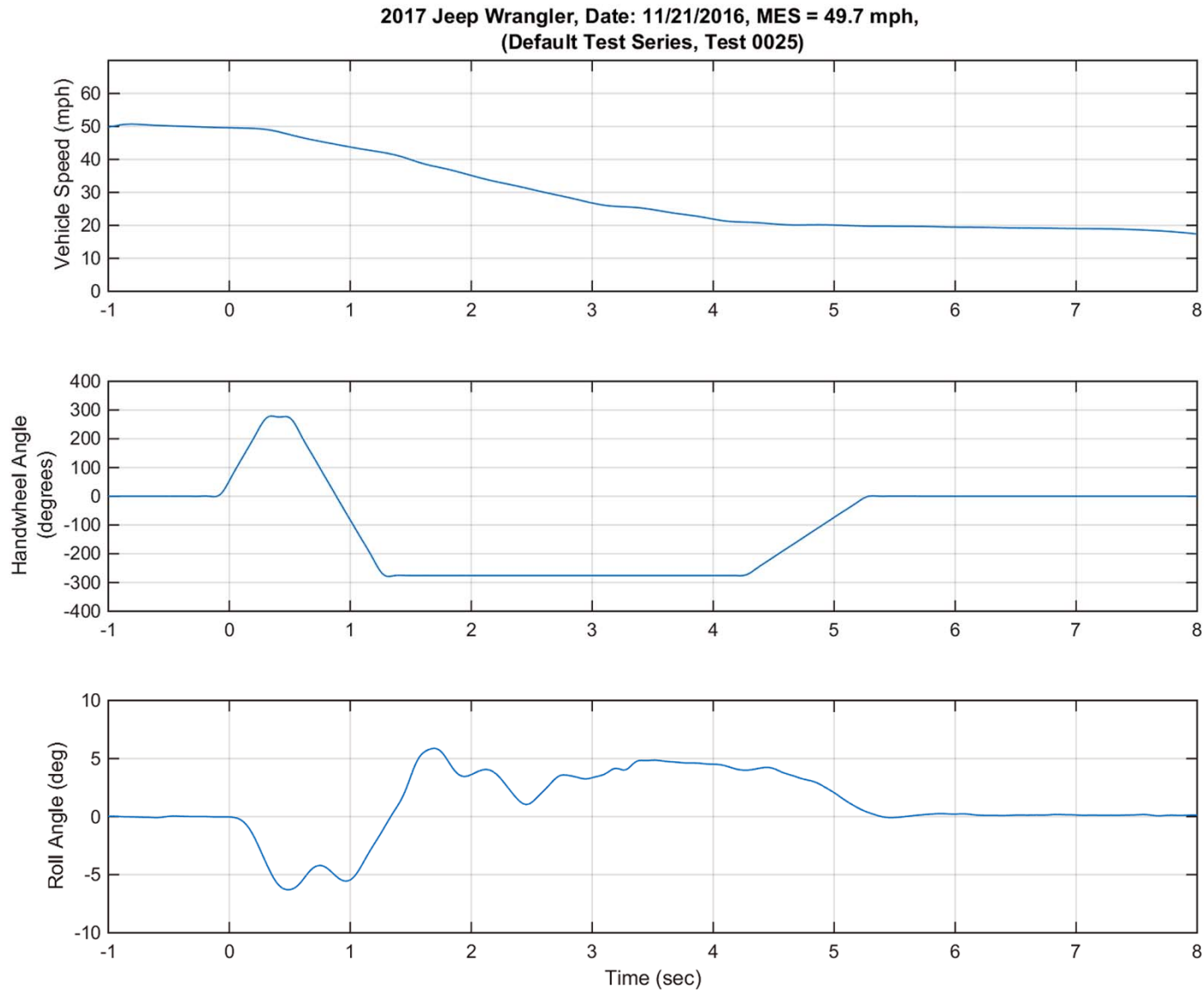

Figure D5. Vehicle Speed, Handwheel Angle, and Roll Angle Time History Plots for Default Test Series, R-L, 50 mph

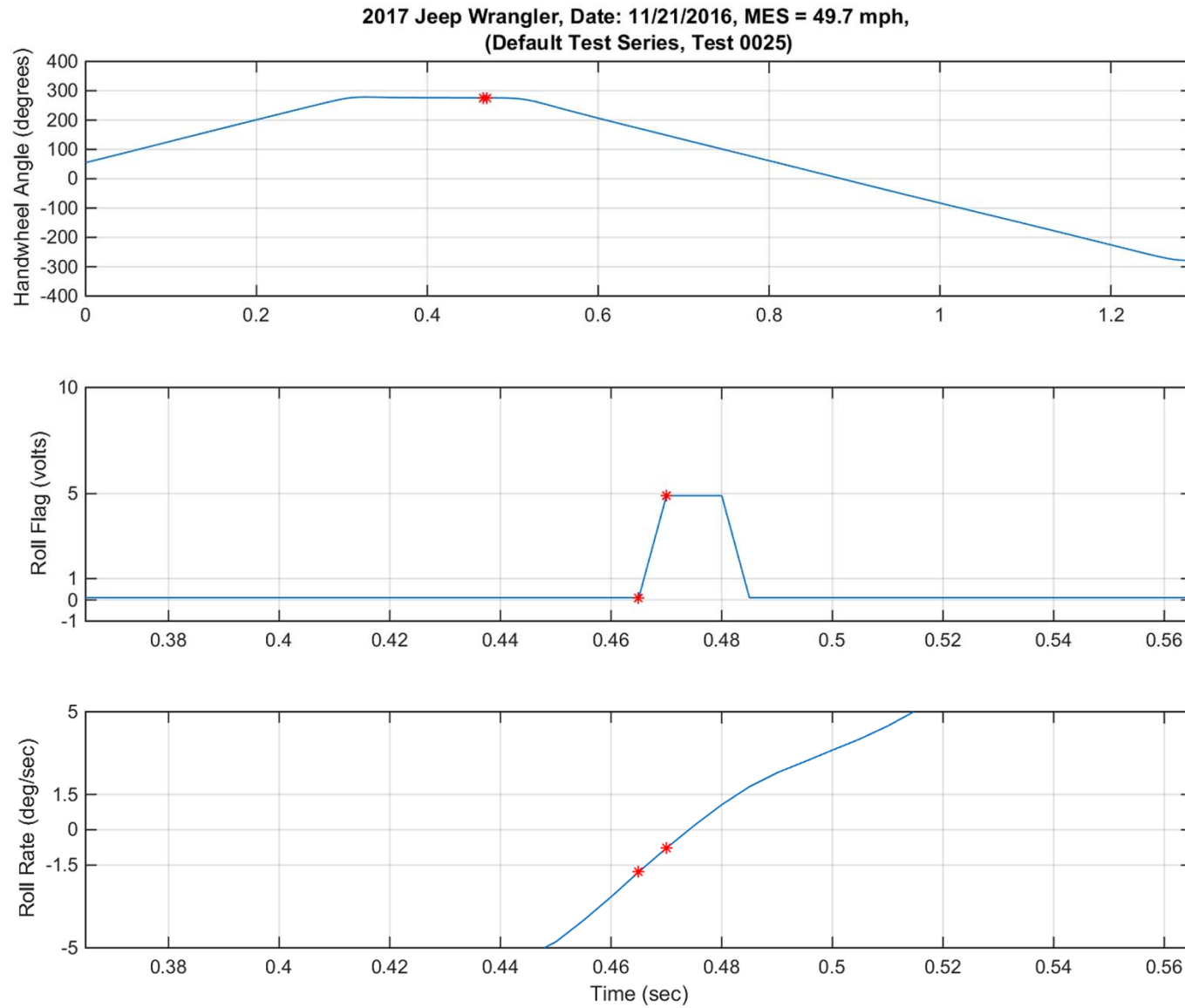

Figure D6. Steering Machine Operation Time History Plots for Default Test Series, R-L, 50 mph

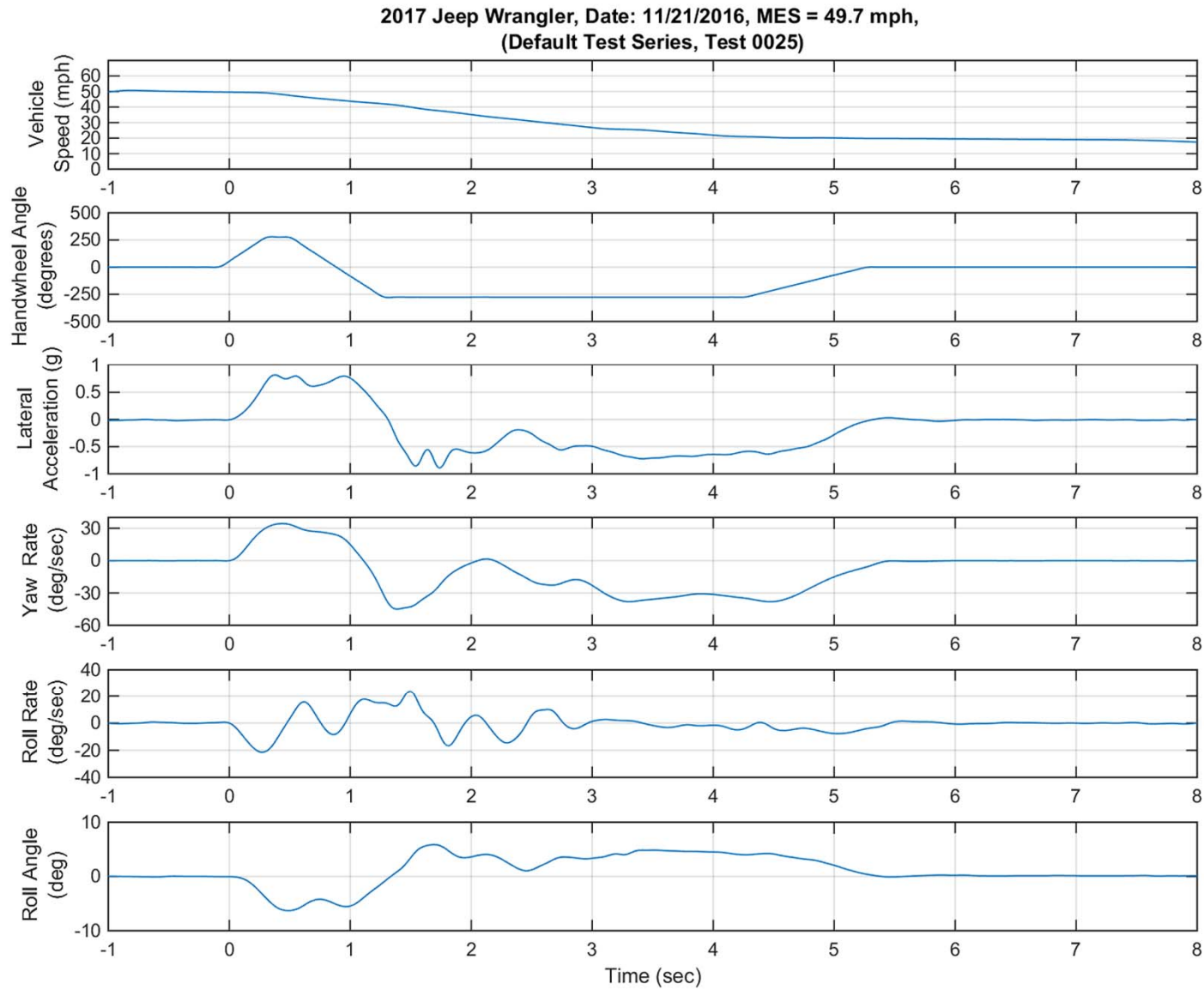

Figure D7. Yaw Rate, Roll Rate, and Lateral Acceleration Time History Plots for Default Test Series, R-L, 50 mph

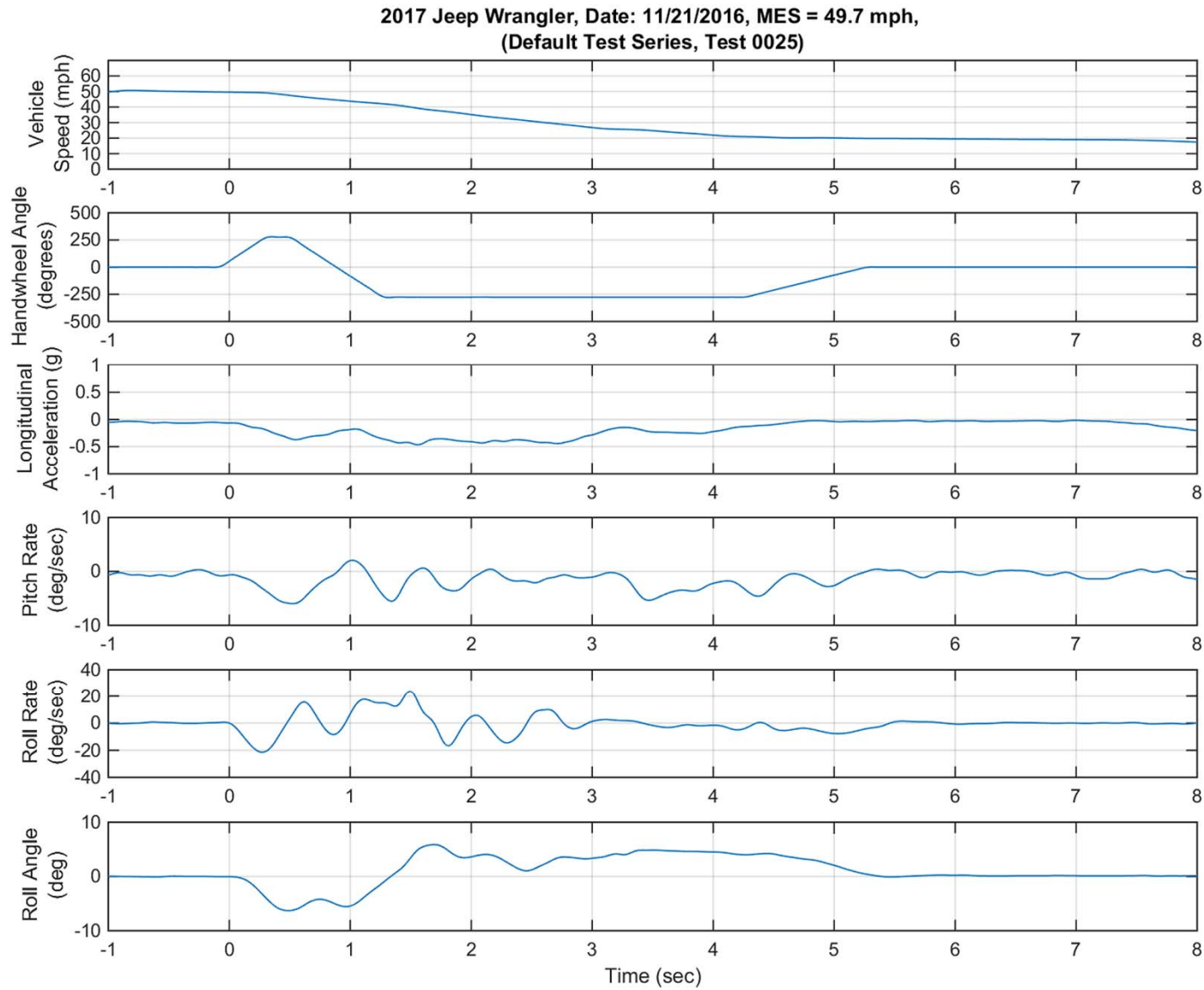

Figure D8. Pitch Rate and Longitudinal Acceleration Time History Plots or Default Test Series, R-L, 50 mph

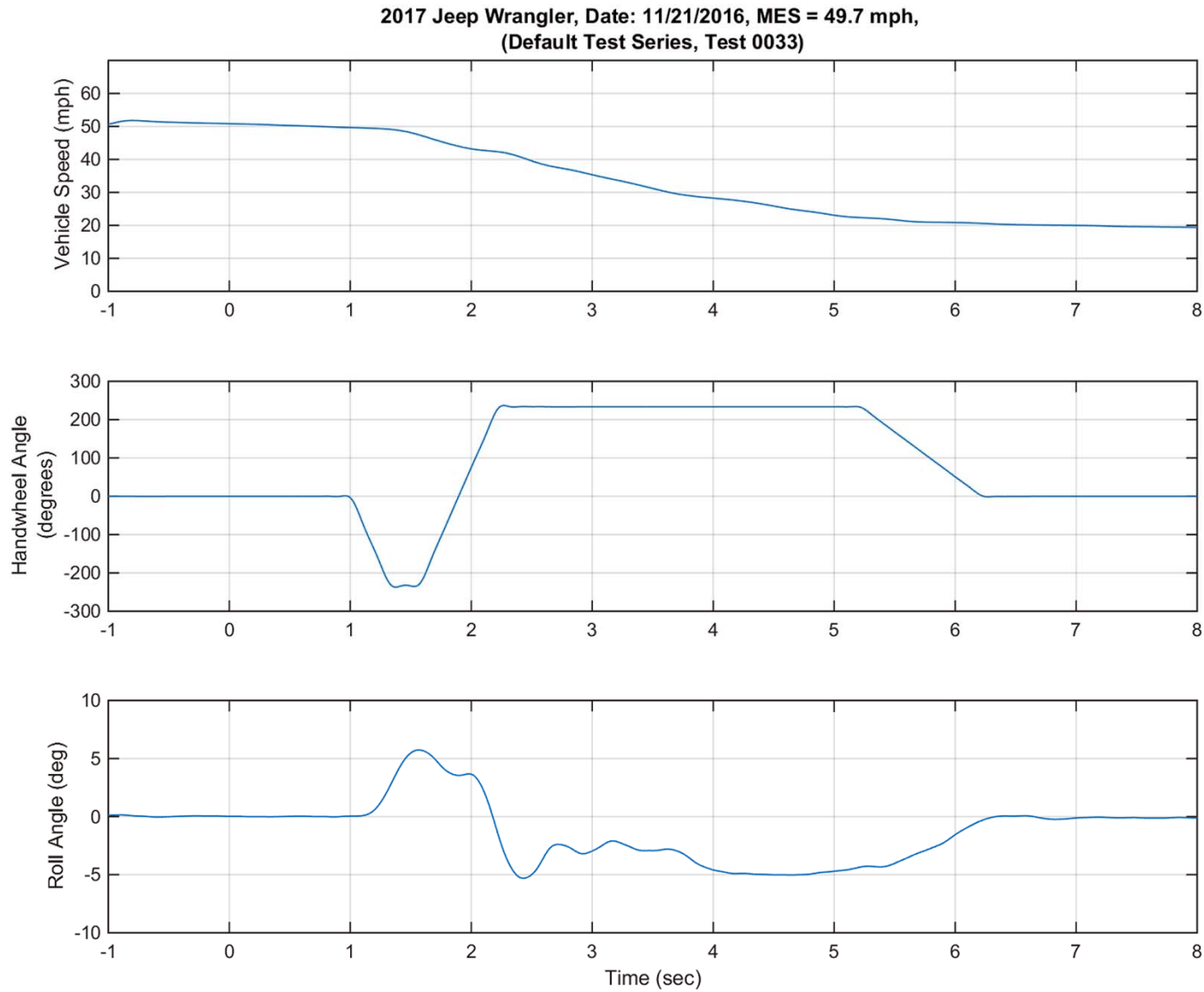

Figure D9. Vehicle Speed, Handwheel Angle, and Roll Angle Time History Plots for Supplemental 2 Test Series, L-R, 50 mph

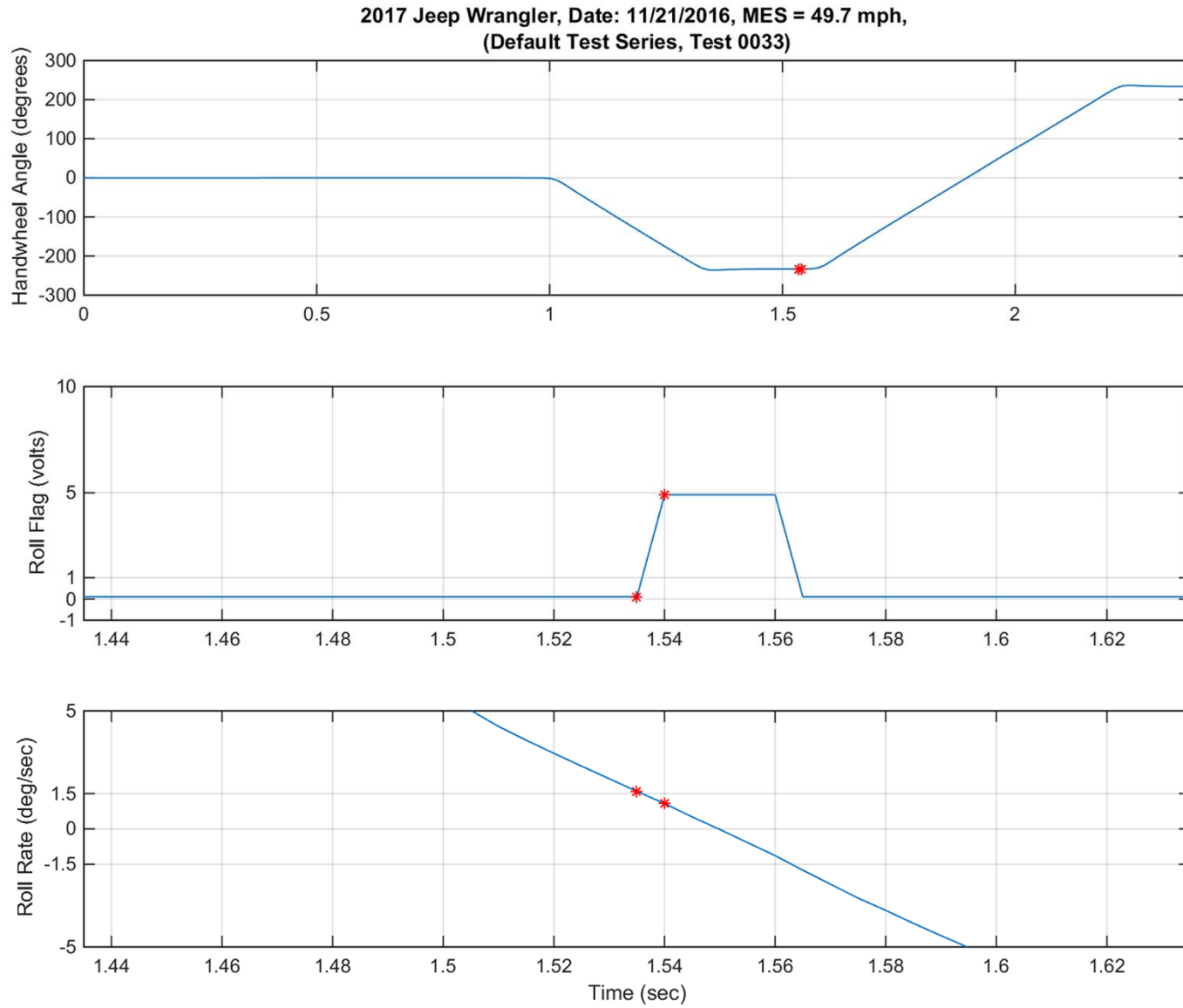

Figure D10. Steering Machine Operation Time History Plots for Supplemental 2 Test Series, L-R, 50 mph

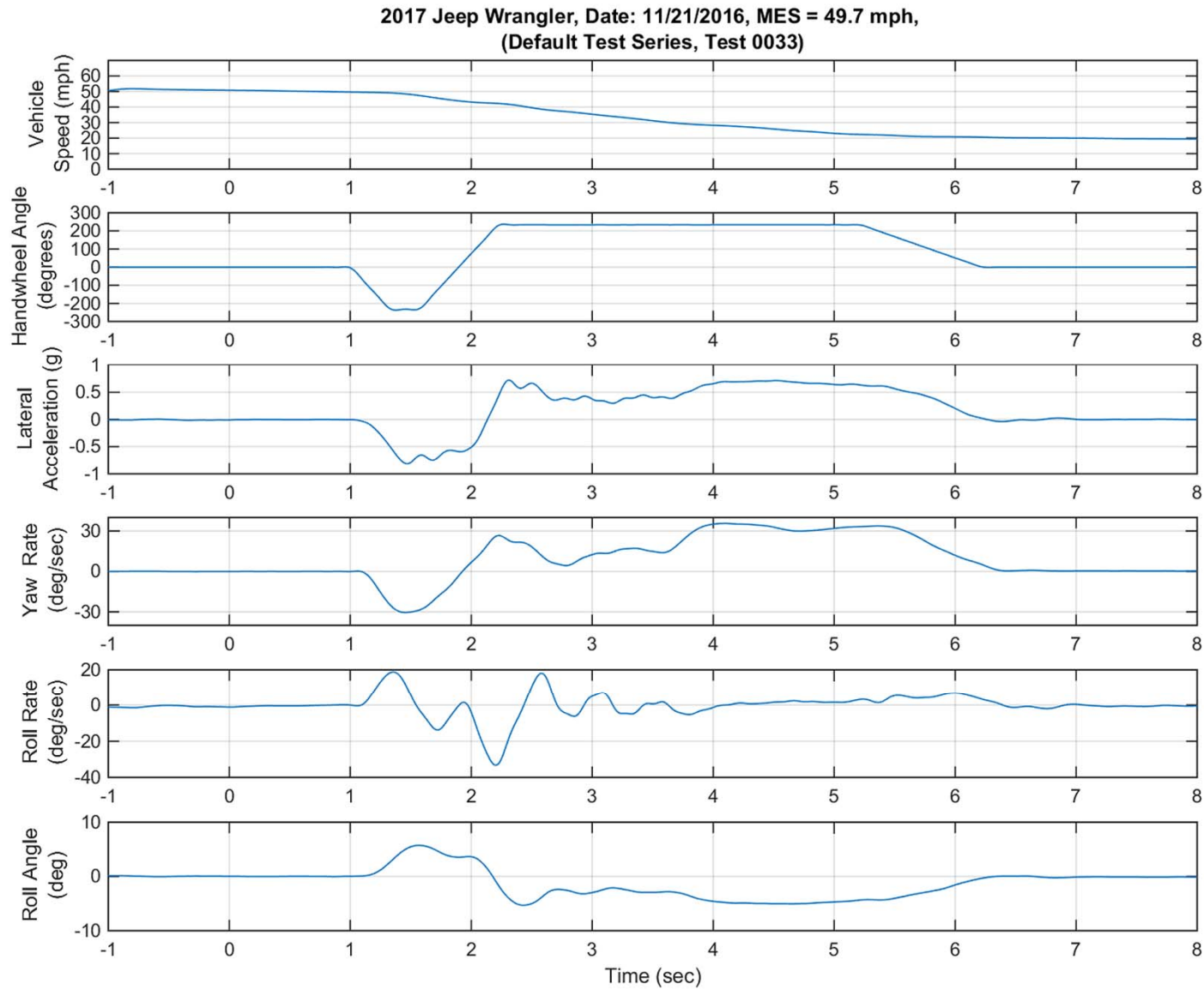

Figure D11. Yaw Rate, Roll Rate, and Lateral Acceleration Time History Plots for Supplemental 2 Test Series, L-R, 50 mph

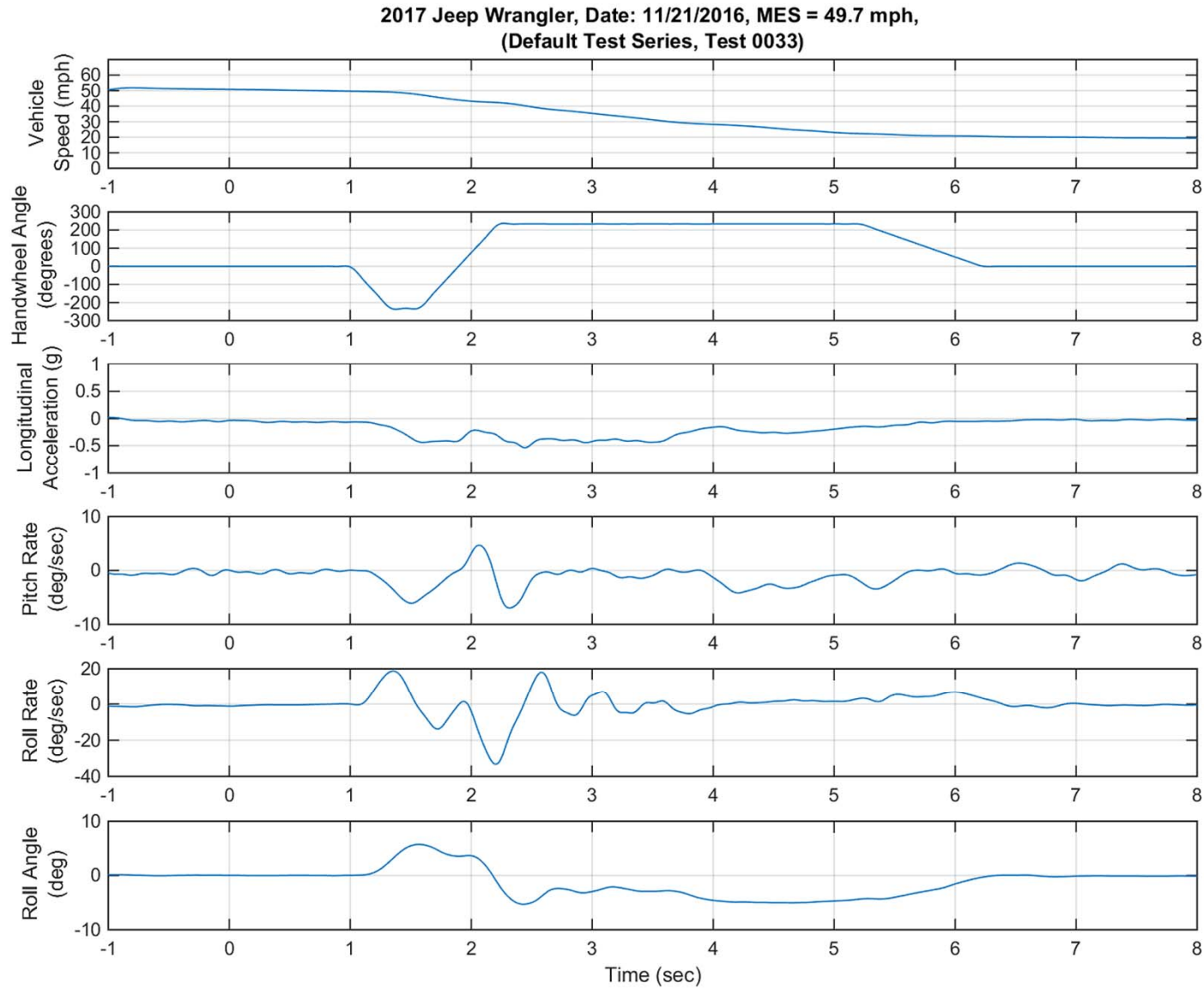

Figure D12. Pitch Rate and Longitudinal Acceleration Time History Plots for Supplemental 2 Test Series, L-R, 50 mph

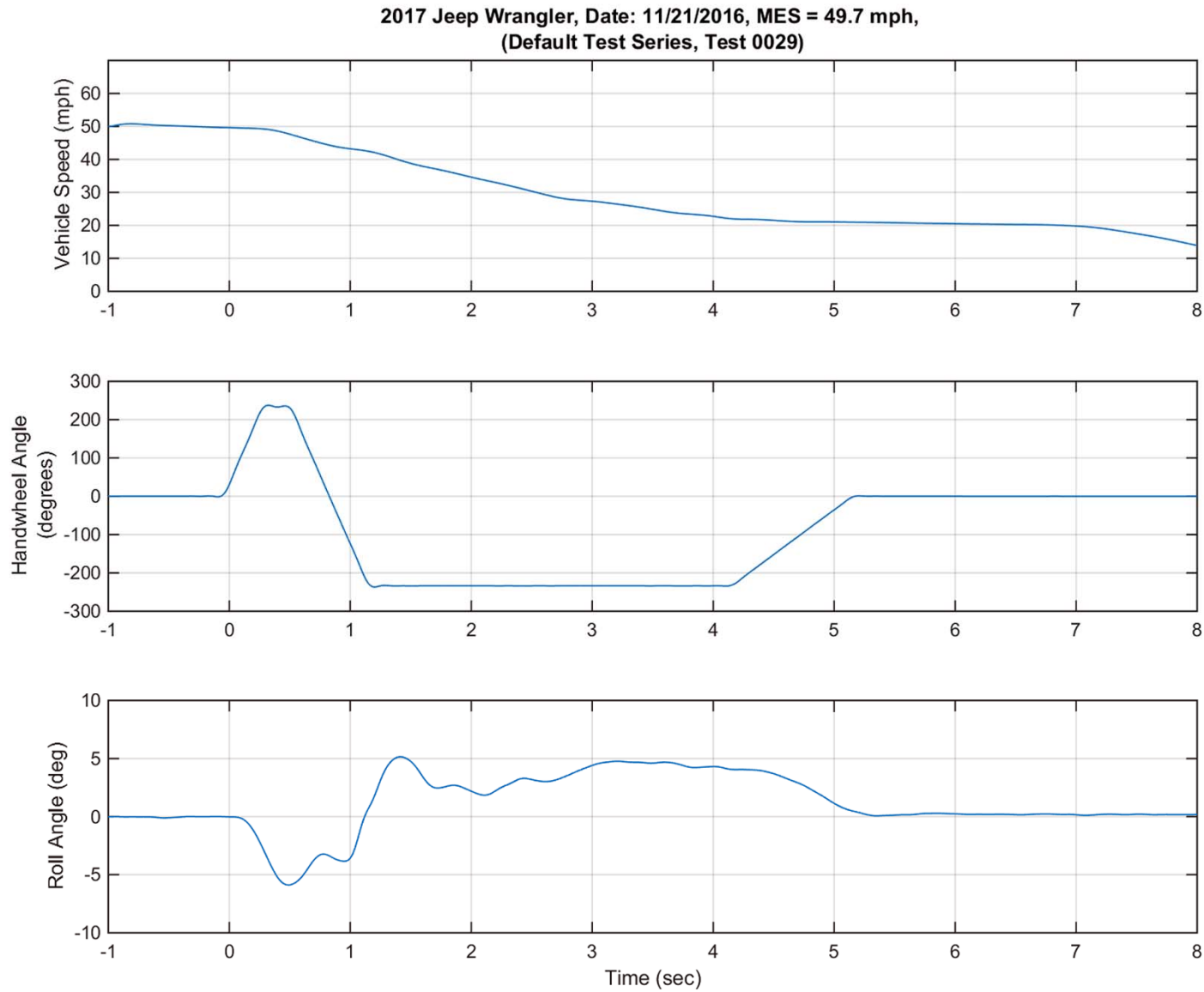

Figure D13. Vehicle Speed, Handwheel Angle, and Roll Angle Time History Plots for Supplemental 2 Test Series, R-L, 50 mph

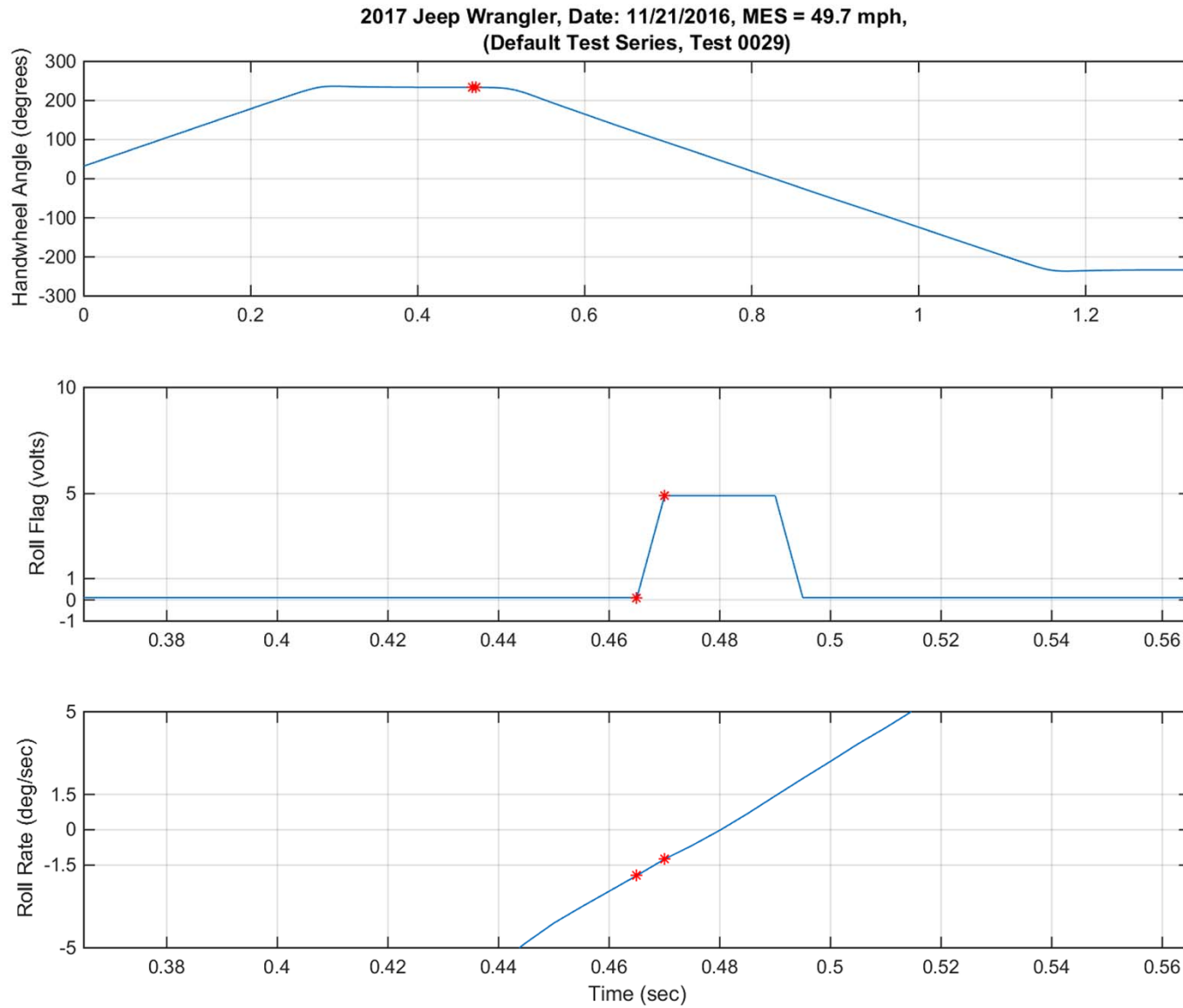

Figure D14. Steering Machine Operation Time History Plots for Supplemental 2 Test Series, R-L, 50 mph

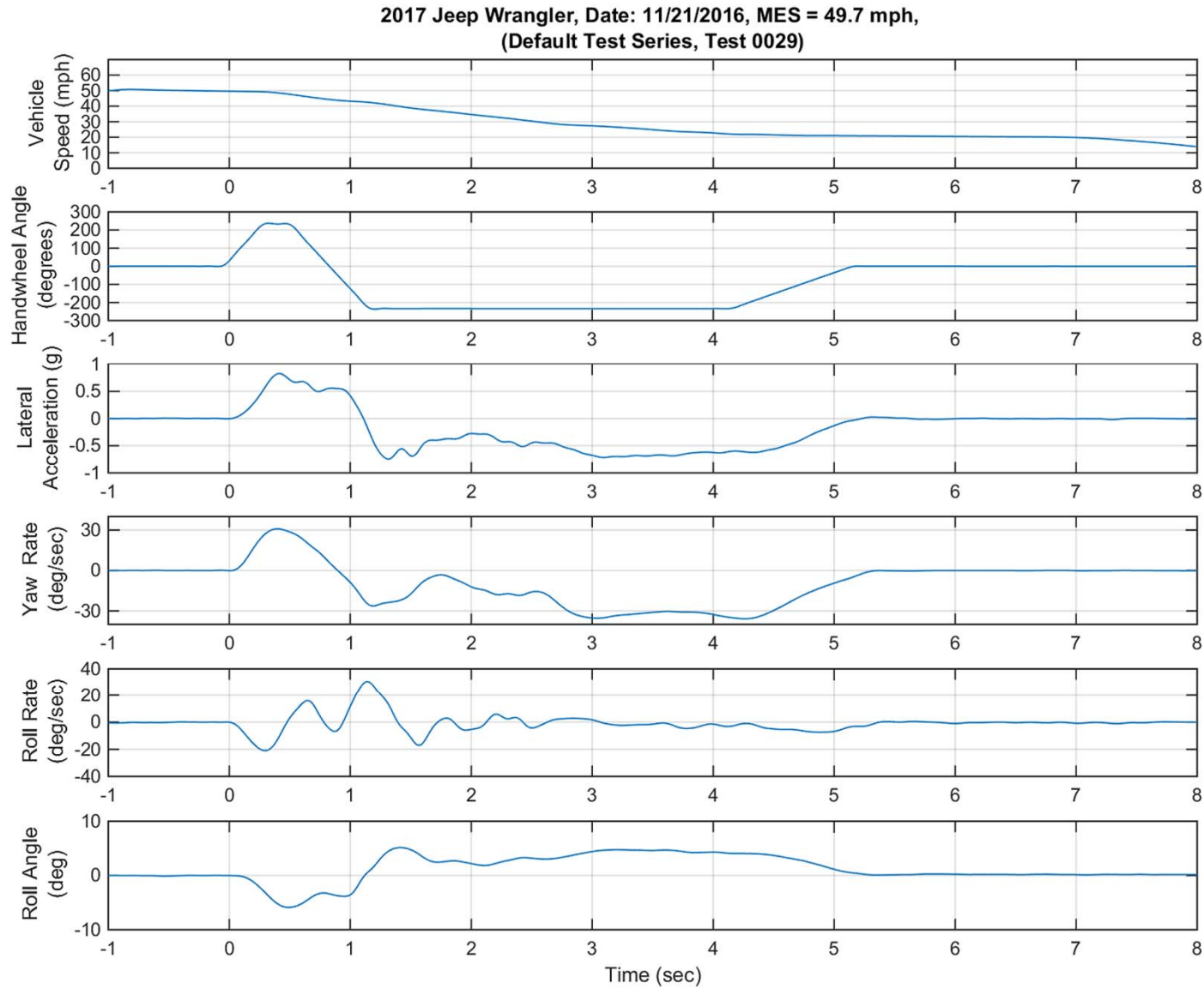

Figure D15. Yaw Rate, Roll Rate, and Lateral Acceleration Time History Plots for Supplemental 2 Test Series, R-L, 50 mph

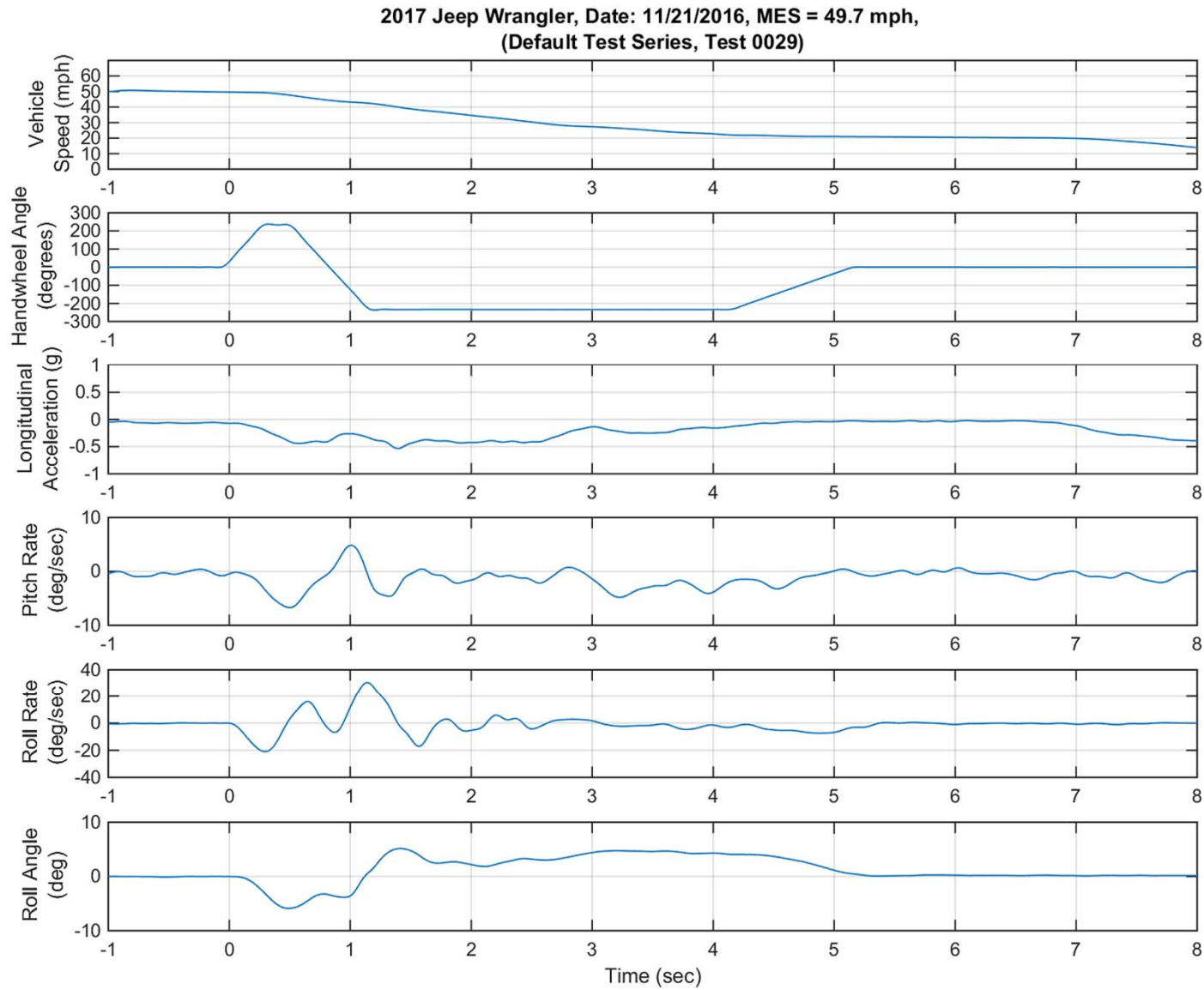

Figure D16. Pitch Rate and Longitudinal Acceleration Time History Plots for Supplemental 2 Test Series, R-L, 50 mph