

**NEW CAR ASSESSMENT PROGRAM (NCAP)  
DYNAMIC ROLLOVER RESISTANCE TEST**

Honda MFG. of Alabama, LLC

2019 Honda Passport FWD

TEST NUMBER: OCAS-DRI-RR-19-21

Final Report  
6 August 2019



Prepared by:

Dynamic Research, Inc  
355 Van Ness Ave. #200  
Torrance, CA 90501

Prepared for:

National Highway Traffic Safety Administration  
Office of Crash Avoidance Standards  
1200 New Jersey Avenue S.E.  
Washington, DC 20590

The United States Government assumes no liability for the contents of this report or use thereof. If trade or manufacturers' names or products are mentioned, it is only because they are considered essential to the object of the publication and should not be construed as an endorsement. The United States Government does not endorse products or manufacturers.

Dynamic Research, Inc. does not endorse or certify products of manufacturers. The manufacturer's name appears solely to identify the test article. Dynamic Research, Inc. assumes no liability for the report or use thereof. It is responsible for the facts and the accuracy of the data presented herein. This report does not constitute a standard, specification, or regulation.

Report Prepared by:

John Lenkeit, Program Manager

Date: 6 August 2019

1. Report No. <b>OCAS-DRI-RR-19-21</b>	2. Government Accession No.	3. Recipient's Catalog No.	
4. Title and Subtitle <b>NCAP Dynamic Rollover Resistance Maneuver (Fishhook) Test of a 2019 Honda Passport FWD MPV</b>		5. Report Date <b>6 August 2019</b>	
		6. Performing Organization Code <b>DRI</b>	
7. Author(s) <b>John Lenkeit, Program Manager Peter Broen, Project Engineer</b>		8. Performing Organization Report No. <b>DRI- TM-19-86</b>	
9. Performing Organization Name and Address <b>Dynamic Research, Inc. 355 Van Ness Ave. #200 Torrance, CA 90501</b>		10. Work Unit No. (TRAIS)	
		11. Contract or Grant No. <b>DTNH22-14-D-00332</b>	
12. Sponsoring Agency Name and Address  <b>National Highway Traffic Safety Administration Office of Crash Avoidance Standards 1200 New Jersey Avenue S.E. Washington, DC 20590</b>		13. Type of Report and Period Covered <b>Final Report March 2019 to August 2019</b>	
		14. Sponsoring Agency Code	
15. Supplemental Notes			
16. Abstract  An NCAP Dynamic Rollover Maneuver (Fishhook) Test was conducted on a 2019 Honda Passport FWD at Dynamic Research, Inc. on March 19, 2019. The vehicle did not experience two-wheel lift. The vehicle's steering angle at 0.3 g lateral acceleration at 50 mph was 32.9 degrees.			
17. Key Words <b>NCAP Rollover Resistance Ratings Fishhook Test</b>		18. Distribution Statement <b>Copies of this report are available from: National Highway Traffic Safety Admin. Office of Crash Avoidance Standards 1200 New Jersey Ave., S.E. Washington, DC 20590</b>	
19. Security Classif. (of this report) <b>Unclassified</b>	20. Security Classif. (of this page) <b>Unclassified</b>	21. Number of Pages <b>55</b>	22. Price

## TABLE OF CONTENTS

	Page
I. INTRODUCTION.....	1
II. VEHICLE PREPARATION .....	2
A. Test Vehicle .....	2
B. Tires .....	2
C. Vehicle Loading.....	2
D. Steering Controller .....	5
E. Real-Time Controller and Data Acquisition .....	5
F. Equipment Weight.....	6
G. Sensors.....	6
H. Other Vehicle Preparation .....	7
III. TEST PROCEDURES.....	10
A. Test Procedure Overview.....	10
B. Test Conditions .....	11
IV. RESULTS.....	14
APPENDIX A Photographs .....	A-1
APPENDIX B Test Run Log.....	B-1
APPENDIX C Slowly Increasing Steer Test Worksheet.....	C-1
APPENDIX D Time History Plots .....	D-1

## LIST OF FIGURES

	Page
1. Nominal Position of Video Cameras for Fishhook Tests .....	9
2. DRI-Minter Vehicle Dynamics Area .....	13

## LIST OF TABLES

	Page
1. Test Vehicle Data .....	3
2. Tire Information .....	4
3. Vehicle Loading .....	4
4. Weight of In-Cab Test equipment.....	6
5. Sensor Specifications .....	8
6. Surface Friction .....	11
7. Handwheel Angles .....	11
8. Weather Conditions.....	12

## Section I INTRODUCTION

Beginning with the 2006 fiscal year, the National Highway Traffic Safety Administration (NHTSA) has engaged Dynamic Research, Inc. (DRI) of Torrance, CA to conduct dynamic rollover testing and gather data from that testing as part of NHTSA's New Car Assessment Program (NCAP).

The purpose of the testing reported herein was to determine if a typical 2019 Honda Passport FWD would experience tip-up, defined as simultaneous two-wheel lift of two inches or more at an entry speed of 50 mph or less in the Fishhook Procedure developed by NHTSA. This procedure may be found at [www.regulations.gov](http://www.regulations.gov), docket item NHTSA-2006-26555-0136.

The testing reported herein was accomplished under contract DTNH22-14-D-00332. The task order is entitled, "NCAP Dynamic Rollover Testing."

## Section II VEHICLE PREPARATION

### A. TEST VEHICLE

The test vehicle was new or in as-new condition, meaning the vehicle had been driven no more than 500 miles prior to the start of dynamic rollover testing. It was acquired through a commercial rental/leasing company. Details of the test vehicle are given in Table 1.

### B. TIRES

All tires used were new, and of the same make, model, size, and DOT specification of those installed on the vehicle when purchased new. Tire inflation pressures were in accordance with the recommendations indicated on each vehicle's identification placard. To further reduce the possibility of tire debanding, the tires were mounted to the rims without the use of tire mounting lubricant. Tire specifications are listed in Table 2.

### C. VEHICLE LOADING

The multi-passenger load, described in the Fishhook Procedure, was used for all tests. The load and positioning of the load in the vehicle are listed in Table 3.

In addition to water dummies, the loading included instrumentation, a steering machine, and outriggers. Test vehicle bumper assemblies were removed for outrigger installation. The reduction in vehicle weight due to the removal of the bumpers was offset by the additional weight of the outriggers and their mounting system. The outrigger system typically outweighs the bumper assemblies.



Table 1. Test Vehicle Data

<b>General Data</b>					
Model year, make, model	2019 Honda Passport FWD				
VIN	5FNYP7H95KB00xxxx				
Body style	MPV				
Number of doors	4				
Trim level	2WD TRG				
Seating positions	Front:	2 <sup>nd</sup> row	3 <sup>rd</sup> row	4 <sup>th</sup> row	5 <sup>th</sup> row
	2	3	0	0	0
Electronic stability control	Yes				
4-Wheel ABS (Yes/No)	Yes				
Power steering (Yes/No)	Yes				
Major optional equipment					
Odometer at start of testing	30 miles				
<b>Drivetrain</b>					
Engine cylinder arrangement	V-6				
Engine displacement	3.5 L				
Transmission type	Automatic				
Drive arrangement	FWD				
<b>Chassis</b>					
Track width	F: 66.13 in (1679.7 mm) , R: 66.5 in (1689.1 mm)				
Wheelbase	111 in (2819.4 mm)				
Curb weight	4008 lb (1818 kg)				
<b>Certification Data from Vehicle's Label</b>					
Vehicle manufactured by	Honda MFG. of Alabama, LLC				
Date of manufacture	12/'18				
GVWR	5291 lb (2400 kg)				
GAWR Front	2734 lb (1240 kg)				
GAWR Rear	2965 lb (1345 kg)				

Table 2. Tire Information

Tire Manufacturer	Continental
Tire Model	Cross Contact LX Sport
Tire Size	Front: 265/45R20 Rear: 265/45R20
Load rating	Front: 104 Rear: 104
Speed rating	Front: H Rear: H
Treadwear grade	Front: 480 Rear: 480
Traction grade	Front: A Rear: A
Temperature grade	Front: A Rear: A
Location of "Recommended Tire Pressure" label	Driver's door jamb
Recommended cold tire pressure	Front: 37 psi, (255 kPa) Rear: 37 psi, (255 kPa)
First 8 digits of DOT code	Front: A3XK D8WV Rear: A3XK D8WV

Table 3. Vehicle Loading

Water dummy and other loading	3 water dummies in second row
Water dummy weight	175 lb (79.4 kg)
Fuel level	Full
<b>Weight as Tested</b>	
Left front	1447 lb (656.3 kg)
Right front	1318 lb (597.8 kg)
Left rear	1113 lb (504.8 kg)
Right rear	1132 lb (513.5 kg)

## D. STEERING CONTROLLER

Precise controlled steering is accomplished using a steering machine designed and constructed by DRI. DRI has used its Automated Vehicle Controller (AVC) steering machine for many vehicle tests including FMVSS 126 tests. It can provide up to 65 ft-lb torque and rates over 1300 deg/sec. The integrated angle encoder has an unlimited range with a resolution of 0.045 degrees and an accuracy of  $\pm 0.045$  degrees. The steering motor is controlled by a MicroAutoBox II from dSPACE, which also acts as the data acquisition system.

## E. REAL-TIME CONTROLLER AND DATA ACQUISITION

Data acquisition is achieved using a MicroAutoBox II from dSPACE, which also serves as the real-time system for the steering controller. Data from the Oxford IMU, including Longitudinal, Lateral, and Vertical Acceleration, Roll, Yaw, and Pitch Rate, Forward and Lateral Velocity, Roll and Pitch Angle, are sent over Ethernet to the Micro AutoBox. The Oxford IMUs are calibrated per the manufacturer's recommended schedule (Table 5). The MicroAutoBox II specifications are:

Model: D-Space Micro-Autobox II 1401/1513  
Base Board SN 549068  
I/O Board SN 588523

Two video cameras were used to record the Fishhook runs. They were positioned nominally as shown in Figure 1. The recorded videotapes were reviewed after the Fishhook runs to check for any two-wheel lift. If any two-wheel lift was observed, eight infrared distance-measuring sensors for measurement of wheel lift (two sensors at each wheel) were then mounted for use in subsequent confirmation Fishhook tests.

## F. EQUIPMENT WEIGHT

Table 4 lists the equipment and associated weights outlined in the NHTSA Laboratory Test Procedure for Dynamic Rollover and the equipment at DRI used for this specific test program. The equipment used at DRI for this test program differs slightly from the equipment that was previously used by NHTSA for rollover testing. Because DRI's equipment is lighter than NHTSA's equipment, DRI uses ballast to maintain a consistent weight and weight distribution in the vehicle.

Table 4. Weight of In-Cab Test Equipment

Equipment	Location	Equipment Weight (lb)	
		NHTSA*	DRI
Data Acquisition System	Front passenger seat	58	
Steering Machine	Handwheel	31	31
Steering Machine Electronics Box	Passenger row foot well behind the front passenger seat. If vehicle does not have a rear passenger row foot well, the Electronics Box should be placed in the front passenger seat foot well.	39	
MABX, and laptop	Front passenger seat		21
Motor control and power supply	Front passenger footwell		26
Ballast	Front passenger footwell		50
<b>Total</b>		<b>128</b>	<b>128</b>

\* Table A.1 from US DOT NHTSA - Laboratory Test Procedure for Dynamic Rollover - The Fishhook Maneuver Test Procedure - New Car Assessment Program (NCAP) - March 2013

## G. SENSORS

A list of the sensors is given in Table 5.

## H. OTHER VEHICLE PREPARATION

In addition to installation and preparation discussed above, the test vehicle was prepared as follows:

- Front and rear bumpers were removed
- Outrigger mounts were installed in the bumper locations and titanium outriggers were fastened to these mounts
- Airbags were removed or otherwise disabled

Photographs of the vehicle tested are given in Appendix A.

Table 5. Sensors

Measured Variable	Sensor	Range	Resolution	Accuracy	Specifics	Serial Number	Calibration
Vehicle Tire Pressure	Tire Pressure Gauge	0-100 psi 0-690 kPa	0.01 psi 6.89 kPa	< 1% error between 20 and 100 psi	Omega DPG8001	17042707002	By: DRI Date: 6/21/2018 Due: 6/21/2019
Vehicle Total, Wheel, and Axle Load	Platform Scales (Minter)	1200 lb/platform 5338 N/platform	1 lb 4.4 N	0.5% of applied load	Intercomp SWI	1110M206352	By: DRI Date: 1/3/2019 Due: 1/3/2020
	Platform Scales (Torrance)	1500 lb/platform 6672 N/platform	1 lb 4.4 N	0.5% of applied load	Intercomp SW I	24032361	By: DRI Date: 12/11/2018 Due: 12/11/2019
Handwheel Angle	Steering Angle Encoder (Automated Steering Controller)	±800 deg	0.045 deg	±0.045 deg	DRI Automatic Vehicle Controller using D-Space Micro- Autobox II	NA	Verified by DRI at installation <sup>1</sup>
Longitudinal, Lateral, and Vertical Acceleration Roll, Yaw, and Pitch Rate, Forward and Lateral Velocity, Roll and Pitch Angle	Multi-Axis Inertial Sensing System	Accels ± 5 g, Angular Rate ±300 deg/s, Angle >45 deg, Velocity >200 km/h	Accels .001 g, Angular Rate 0.01 deg/s, Angle 0.05 deg, Velocity 0.1 km/h	Accels .001g, Angular Rate 0.01 deg/s, Angle 0.05 deg, Velocity 0.1 km/h	Oxford xNav 550	015360	By: Oxford Technical Solutions Date: 6/21/2017 Due: 6/21/2019

1 . The steering encoder is checked prior to beginning tests to verify that there are no faults. The steering controller is installed in the vehicle and the steering wheel is turned through two complete revolutions while recording data. The data are then reviewed for any dropouts or other nonlinearities that would indicate dust intrusion or faulty sectors.

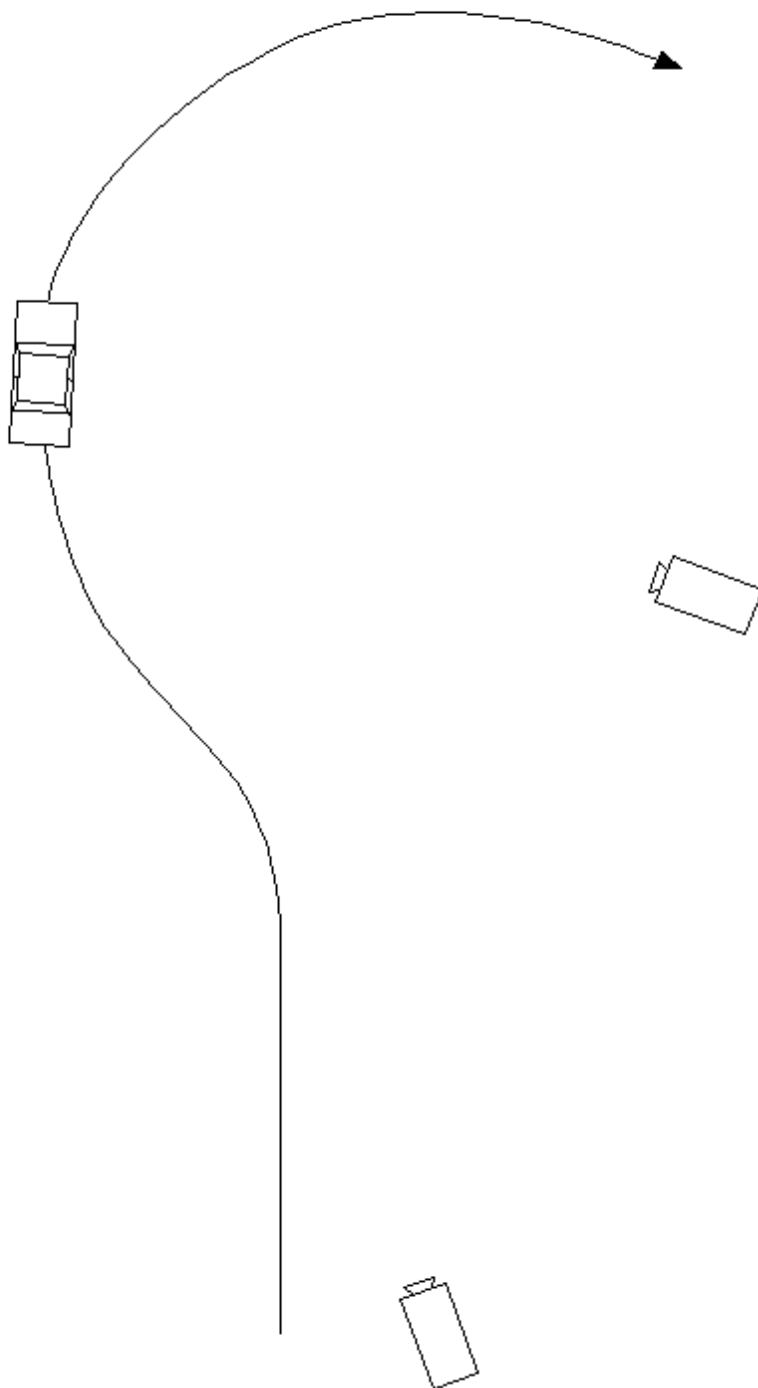

Figure 1. Nominal Position of Video Cameras for Fishhook Tests

## Section III TEST PROCEDURES

This section includes a general overview of the test procedures and details of the particular test.

### A. TEST PROCEDURE OVERVIEW

This test was conducted in accordance with NHTSA's NCAP Rollover Resistance Test Procedure (Fishhook) as described in the Federal Register (68 FR 59250). Detailed descriptions of the test procedure, pass/fail criteria, and data acquisition specifications may be found at docket NHTSA-2001-9663.

There are two major components of the test procedure, the Slowly Increasing Steer (SIS) pre-test and the Fishhook test.

The Slowly Increasing Steer (SIS) maneuver was used to characterize the steady state lateral dynamics of each vehicle, and is based on the "Constant Speed, Variable Steer" test defined in SAE J266. The maneuver is used to determine the handwheel angle that produces a lateral acceleration of 0.3 g at 50 mph. This handwheel angle is then used to determine the magnitude of steering to be used for the NHTSA Fishhook maneuver.

SIS tests were performed at a constant speed of 50 mph. Handwheel angle was input at a rate of 13.5 deg/sec, from 0 to an angle that provided at least 0.55 g. Three tests were conducted in each direction, and the data for the six runs were averaged to obtain the handwheel angle that produced 0.3 g at 50 mph.

The Fishhook test is a programmed steering maneuver that is implemented via the steering controller. The vehicle was initially steered in one direction and then the steering was reversed. The timing, magnitude and rate of the steering were prescribed by the Fishhook Procedure.

To begin the maneuver, the vehicle was driven in a straight line at a speed slightly greater than the desired entrance speed. The driver then released the throttle. When the vehicle was at the target speed, the steering controller automatically initiated the steering maneuver. Following completion of the steering reversal, the handwheel position was maintained for three seconds and then returned to zero angle in 1 second.



The tests were conducted in both left-right and right-left directions. The “Default” test series used a handwheel angle equal to 6.5 times the handwheel angle that produced 0.3 g at 50 mph in the SIS tests, and initial vehicle speeds beginning at 35 mph and concluding up to 50 mph (if no two-wheel lift occurs). Supplemental tests were also done, as specified in the Fishhook Procedure.

## B. TEST CONDITIONS

### 1. Test Surface

The tests were conducted on the Vehicle Dynamics Area at DRI’s Minter Field facility, located near Bakersfield, California, on 3/19/2019. The VDA has a smooth, flat (slope less than 0.5% throughout) asphaltic concrete surface. Its dimensions are as shown in Figure 2. It was built in the spring of 2005.

VDA surface friction measurements were accomplished using the DRI Mobile Tire Tester. Three runs were done, one at each of three previously determined locations. Each run provided for a minimum of 3 seconds of tire friction at constant normal load, slip angle, and speed in a free rolling condition. The test was accomplished using an ASTM E1136 tire with an inflation pressure of 35 ( $\pm 0.5$ ) psi at a test speed of 40 ( $\pm 0.5$ ) mph. The net slip angle of the test tire for each test run was 7.5 deg. The test tire was no older than 6 months from the date of manufacture. The surface friction measurement results are shown in Table 6.

Table 6. Surface Friction

Date of surface friction measurements	3/19/2019
Average normalized lateral force	0.826

### 2. Fishhook Handwheel Angles

The 0.3 g handwheel angle obtained from the SIS tests and the handwheel angles used in the Fishhook tests are shown in Table 7.

Table 7. Handwheel Angles

0.3 g handwheel angle (from SIS tests at 50 mph)	32.9°
5.5 scalar handwheel angle for Fishhook Test	181°
6.5 scalar handwheel angle for Fishhook Test	214°

### 3. Weather Conditions

The weather conditions, recorded at the end of testing, are shown in Table 8.

Table 8. Weather Conditions

Ambient temperature	62.6° F ( 17° C)
Wind Speed	3.45 mph (1.5 m/s)
Wind Direction	40

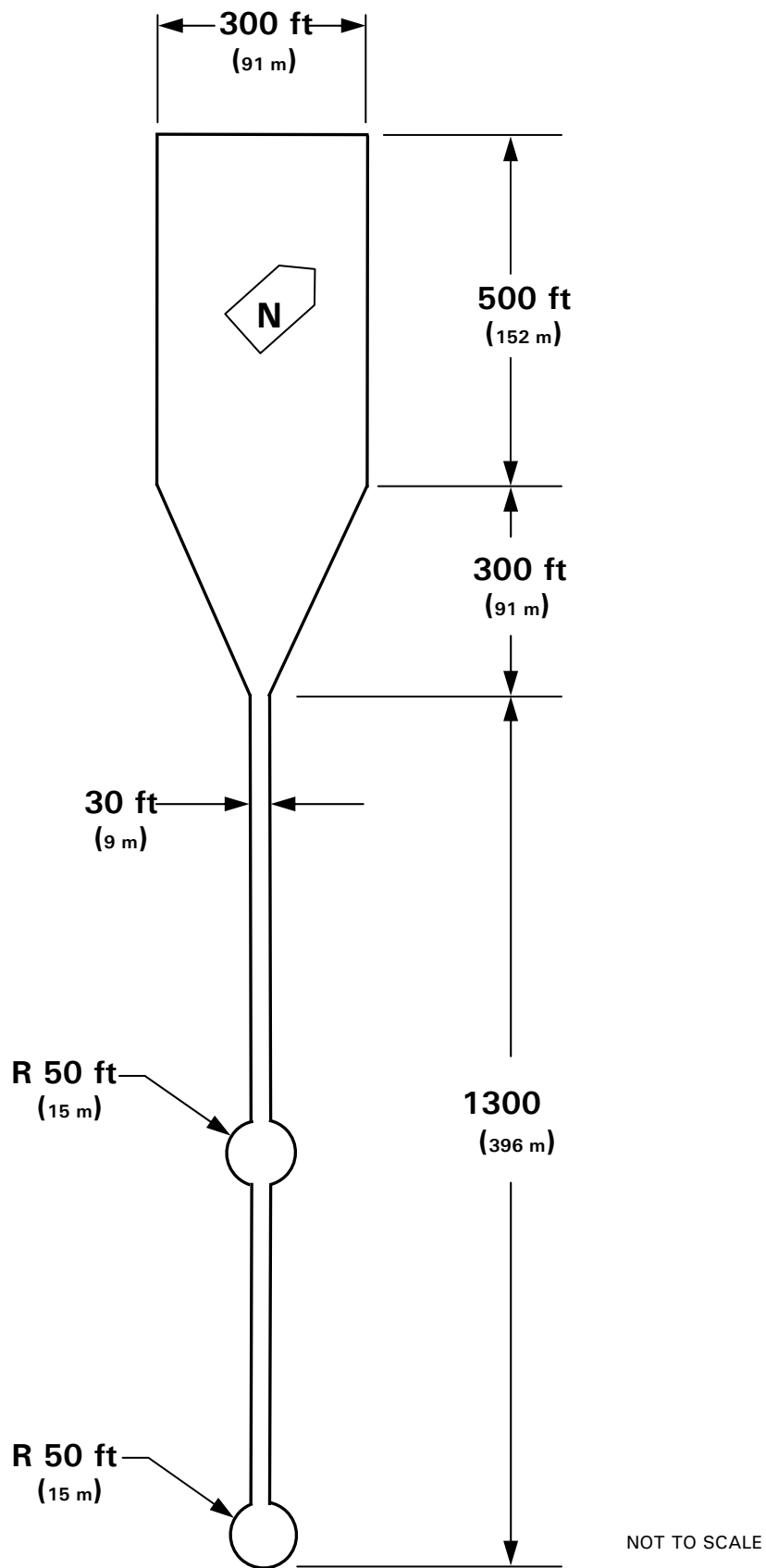

Figure 2. DRI-Minter Vehicle Dynamics Area

## Section IV

### RESULTS

The test run log is given in Appendix B. The Slowly Increasing Steer Test Worksheet is given in Appendix C. Appendix D contains time history plots for the 50 mph runs and any runs which resulted in two-wheel lift. For the 2019 Honda Passport FWD, there was no two-wheel lift at any test condition.

APPENDIX A

Photographs

## LIST OF FIGURES

	Page
A1. Window Sticker.....	A-3
A2. Front View, Test Vehicle as Delivered .....	A-4
A3. Rear View, Test Vehicle as Delivered .....	A-5
A4. Front View, Test Vehicle in Test Condition .....	A-6
A5. Rear View, Test Vehicle in Test Condition .....	A-7
A6. Certification Label.....	A-8
A7. Tire Placard .....	A-9
A8. Instrumentation in Test Vehicle .....	A-10
A9. Steering Controller and Computer .....	A-11
A10. Ballast Condition.....	A-12

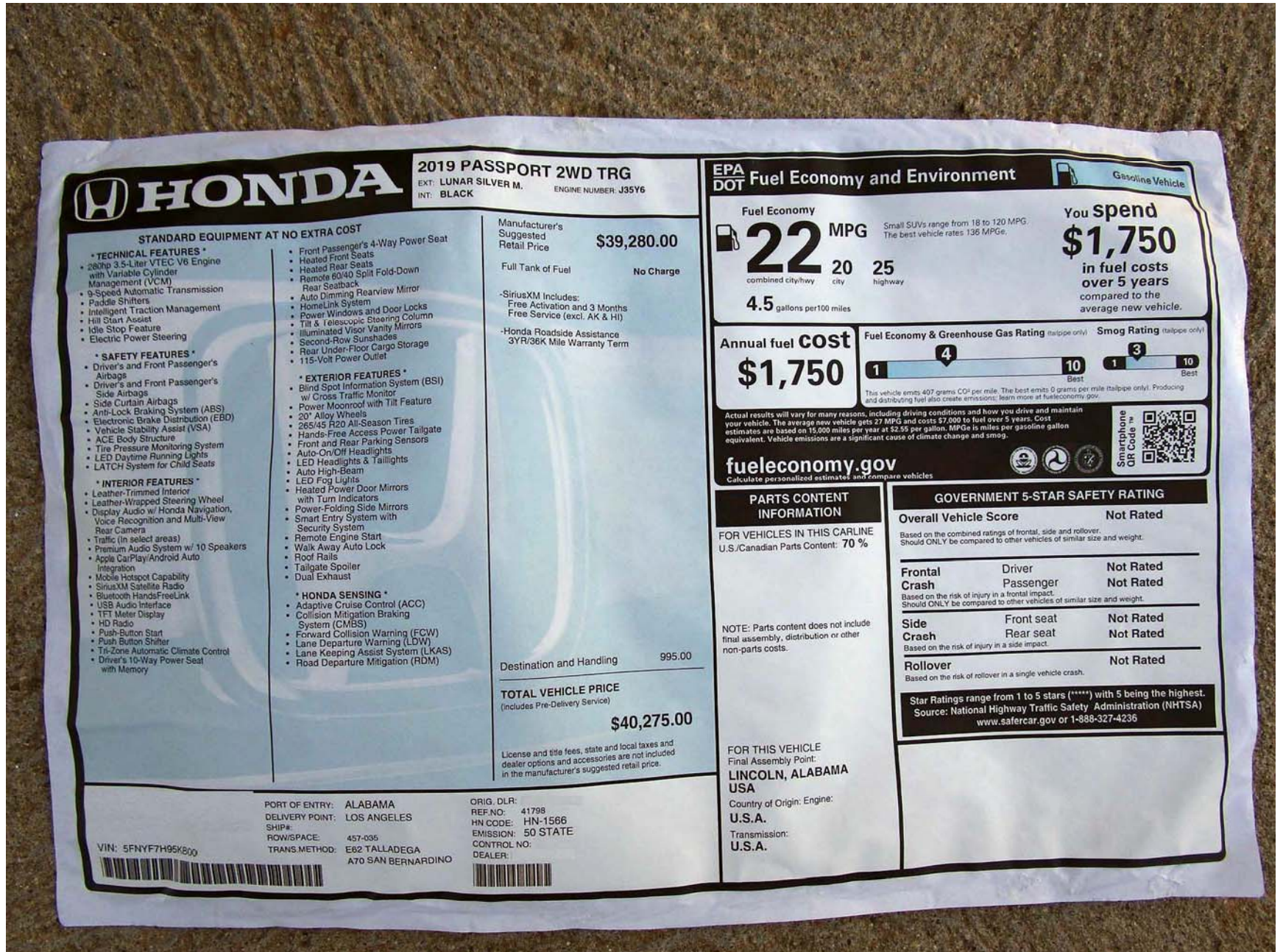

**2019 PASSPORT 2WD TRG**  
 EXT: LUNAR SILVER M. ENGINE NUMBER: J35Y6  
 INT: BLACK

**STANDARD EQUIPMENT AT NO EXTRA COST**

**\* TECHNICAL FEATURES \***

- 260hp 3.5-Liter VTEC V6 Engine with Variable Cylinder Management (VCM)
- 9-Speed Automatic Transmission
- Paddle Shifters
- Intelligent Traction Management
- Hill Start Assist
- Idle Stop Feature
- Electric Power Steering

**\* SAFETY FEATURES \***

- Driver's and Front Passenger's Airbags
- Driver's and Front Passenger's Side Airbags
- Side Curtain Airbags
- Anti-Lock Braking System (ABS)
- Electronic Brake Distribution (EBD)
- Vehicle Stability Assist (VSA)
- ACE Body Structure
- Tire Pressure Monitoring System
- LED Daytime Running Lights
- LATCH System for Child Seats

**\* INTERIOR FEATURES \***

- Leather-Trimmed Interior
- Leather-Wrapped Steering Wheel
- Display Audio w/ Honda Navigation, Voice Recognition and Multi-View Rear Camera
- Traffic (in select areas)
- Premium Audio System w/ 10 Speakers
- Apple CarPlay/Android Auto Integration
- Mobile Hotspot Capability
- SiriusXM Satellite Radio
- Bluetooth HandsFreeLink
- USB Audio Interface
- TFT Meter Display
- HD Radio
- Push-Button Start
- Push Button Shifter
- Tri-Zone Automatic Climate Control
- Driver's 10-Way Power Seat with Memory

**\* EXTERIOR FEATURES \***

- Front Passenger's 4-Way Power Seat
- Heated Front Seats
- Heated Rear Seats
- Remote 60/40 Split Fold-Down Rear Seatback
- Auto Dimming Rearview Mirror
- HomeLink System
- Power Windows and Door Locks
- Tilt & Telescopic Steering Column
- Illuminated Visor Vanity Mirrors
- Second-Row Sunshades
- Rear Under-Floor Cargo Storage
- 115-Volt Power Outlet

**\* EXTERIOR FEATURES \***

- Blind Spot Information System (BSI) w/ Cross Traffic Monitor
- Power Moonroof with Tilt Feature
- 20" Alloy Wheels
- 265/45 R20 All-Season Tires
- Hands-Free Access Power Tailgate
- Front and Rear Parking Sensors
- Auto-On/Off Headlights
- LED Headlights & Taillights
- Auto High-Beam LED Fog Lights
- Heated Power Door Mirrors with Turn Indicators
- Power-Folding Side Mirrors
- Smart Entry System with Security System
- Remote Engine Start
- Walk Away Auto Lock
- Roof Rails
- Tailgate Spoiler
- Dual Exhaust

**\* HONDA SENSING \***

- Adaptive Cruise Control (ACC)
- Collision Mitigation Braking System (CMBS)
- Forward Collision Warning (FCW)
- Lane Departure Warning (LDW)
- Lane Keeping Assist System (LKAS)
- Road Departure Mitigation (RDM)

Manufacturer's Suggested Retail Price **\$39,280.00**

Full Tank of Fuel **No Charge**

SiriusXM Includes: Free Activation and 3 Months Free Service (excl. AK & HI)

Honda Roadside Assistance 3YR/36K Mile Warranty Term

Destination and Handling **995.00**

**TOTAL VEHICLE PRICE**  
 (Includes Pre-Delivery Service)  
**\$40,275.00**

License and title fees, state and local taxes and dealer options and accessories are not included in the manufacturer's suggested retail price.

PORT OF ENTRY: ALABAMA  
 DELIVERY POINT: LOS ANGELES  
 SHIP#:   
 ROW/SPACE: 457-035  
 TRANS.METHOD: E62 TALLADEGA  
 A70 SAN BERNARDINO

ORIG. DLR:  
 REF.NO: 41798  
 HN CODE: HN-1566  
 EMISSION: 50 STATE  
 CONTROL NO:  
 DEALER:

VIN: 5FN9F7H95K600



**EPA DOT Fuel Economy and Environment**

**Fuel Economy**  
**22** MPG  
 combined city/hwy  
 20 city  
 25 highway  
**4.5** gallons per 100 miles

Small SUVs range from 18 to 120 MPG. The best vehicle rates 136 MPGe.

**You spend \$1,750**  
 in fuel costs over 5 years compared to the average new vehicle.

**Annual fuel cost \$1,750**

**Fuel Economy & Greenhouse Gas Rating** (tailpipe only)



**Smog Rating** (tailpipe only)

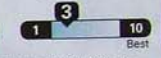

This vehicle emits 407 grams CO<sub>2</sub> per mile. The best emits 0 grams per mile (tailpipe only). Producing and distributing fuel also create emissions; learn more at fueleconomy.gov

Actual results will vary for many reasons, including driving conditions and how you drive and maintain your vehicle. The average new vehicle gets 27 MPG and costs \$7,000 to fuel over 5 years. Cost estimates are based on 15,000 miles per year at \$2.55 per gallon. MPGe is miles per gasoline gallon equivalent. Vehicle emissions are a significant cause of climate change and smog.

**fueleconomy.gov**  
 Calculate personalized estimates and compare vehicles



**PARTS CONTENT INFORMATION**

FOR VEHICLES IN THIS CARLINE  
 U.S./Canadian Parts Content: **70 %**

NOTE: Parts content does not include final assembly, distribution or other non-parts costs.

FOR THIS VEHICLE  
 Final Assembly Point:  
**LINCOLN, ALABAMA USA**  
 Country of Origin: Engine:  
**U.S.A.**  
 Transmission:  
**U.S.A.**

**GOVERNMENT 5-STAR SAFETY RATING**

**Overall Vehicle Score Not Rated**

Based on the combined ratings of frontal, side and rollover. Should ONLY be compared to other vehicles of similar size and weight.

**Frontal Crash** Driver Passenger **Not Rated**  
**Not Rated**

Based on the risk of injury in a frontal impact. Should ONLY be compared to other vehicles of similar size and weight.

**Side Crash** Front seat Rear seat **Not Rated**  
**Not Rated**

Based on the risk of injury in a side impact.

**Rollover Not Rated**

Based on the risk of rollover in a single vehicle crash.

Star Ratings range from 1 to 5 stars (\*\*\*\*\*), with 5 being the highest. Source: National Highway Traffic Safety Administration (NHTSA) www.safercar.gov or 1-888-327-4236





Figure A2. Front View, Test Vehicle as Delivered





Figure A3. Rear View, Test Vehicle as Delivered





Figure A4. Front View, Test Vehicle in Test Condition





Figure A5. Rear View, Test Vehicle in Test Condition





Figure A6. Certification Label



**MFD. BY HONDA MFG. OF ALABAMA, LLC**

<b>GVWR</b>	<b>2400 KG (5291 LBS)</b>	<b>TIRE SIZE</b>	<b>12/'18</b>
<b>GAWR F</b>	<b>1240 KG (2734 LBS)</b>	<b>265/45R20 104H</b>	<b>RIM SIZE</b>
<b>GAWR R</b>	<b>1345 KG (2965 LBS)</b>	<b>265/45R20 104H</b>	<b>20X8.5J</b>

**THIS VEHICLE CONFORMS TO ALL APPLICABLE  
FEDERAL MOTOR VEHICLE SAFETY  
AND THEFT PREVENTION STANDARDS IN EFFECT  
ON THE DATE OF MANUFACTURE SHOWN ABOVE.**

**V.I.N.: 5FNYF7H95KB00**

**TYPE: MPV**



**TGT K AD5 - NH830M -V - B**

Figure A7. Tire Placard





Figure A8. Instrumentation in Test Vehicle



Figure A9. Steering Controller and Computer





Figure A10. Ballast Condition



APPENDIX B

Test Run Log

Vehicle: **2019 Honda Passport FWD**Driver: **Jonathan Robel**Test Date: **3/19/2019**

Run Number	Test Type	Speed (mph)	Handwheel Angle (deg)	Dir. of First Steer	2 Wheel Lift	Notes
1	Tire Warm-Up	35	50	Right	NA	
2	"	"	70	"	"	
3	"	"	"	"	"	
4	"	"	"	"	"	
5	2x SWA last cycle	"	"	"	"	
6	Static	0	0			
7	Steady State	50	0			
8	<b>Slowly Increasing Steer</b>	50	60	Left	NA	
9	"	"	50	Left	"	
10	"	"	"	Left	"	
11	"	"	"	Left	"	
12	"	"	"	Right	"	
13	"	"	"	Right	"	
14	"	"	"	Right	"	
15	<b>Fishhook 6.5 Scalar</b>	35	214	Left	No	
16	"	40	"	"	"	
17	"	45	"	"	"	
18	"	47.5	"	"	"	
19	"	50	"	"	"	

Vehicle: **2019 Honda Passport FWD**Driver: **Jonathan Robel**Test Date: **3/19/2019**

Run Number	Test Type	Speed (mph)	Handwheel Angle (deg)	Dir. of First Steer	2 Wheel Lift	Notes
20	<b>Fishhook 5.5 Scalar</b>	45	181	Left	No	
21	"	47.5	"	"	"	
22	"	50	"	"	"	
23	<b>Fishhook 6.5 Scalar</b>	35	214	Right	No	
24	"	40	"	"	"	
25	"	45	"	"	"	
26	"	47.5	"	"	"	
27	"	50	"	"	"	
28	<b>Fishhook 5.5 Scalar</b>	45	181	Right	No	
29	"	47.5	"	"	"	
30	"	50	"	"	"	

APPENDIX C

Slowly Increasing Steer Test Worksheet

## NCAP, 2019 Honda Passport FWD , Multi-Passenger Load, Test Date: 3/19/2019

SIS\_out\_v2

Run	Dir of Steer	Start Speed (mph)	End Speed (mph)	Speed Red. (%)	Index of ay @ 0.3g	HW Angle (deg) at 0.3g	ay (g) @ 0.3g index	6.5x HW Angle (deg)	Ramp Time (sec) at 6.5x	5.5x HW Angle (deg)	Ramp Time (sec) at 5.5x	R2	Zero Begin Index	Zero End Index
9	L	50.0	0.0	99.9	1084	-32.8	-0.302	-213.3	-0.2962	-180.5	-0.2506	0.9984	400	600
10	L	49.9	1.0	98.0	1076	-32.1	-0.299	-208.7	-0.2898	-176.6	-0.2452	0.9983	400	600
11	L	50.0	3.4	93.2	1090	-33.2	-0.305	-215.7	-0.2996	-182.5	-0.2535	0.9981	400	600
12	R	49.5	4.0	92.0	1098	33.0	0.289	214.2	0.2975	181.2	0.2517	0.9913	400	600
13	R	49.2	11.0	77.5	1100	33.2	0.281	215.8	0.2997	182.6	0.2536	0.9888	400	600
14	R	49.8	3.8	92.3	1099	33.1	0.308	214.9	0.2985	181.8	0.2526	0.9953	400	600

Mean: 32.9 0.297 214 0.297 181 0.251

## Steering Controller Input Values

## Scalar 6.5 values:

Initial HW angle: 214 deg  
 Initial time: 0.297 s  
 Reversal HW angle: -214 deg  
 Reversal time: 0.594 s

## Scalar 5.5 values:

Initial HW angle: 181 deg  
 Initial time: 0.251 s  
 Reversal HW angle: -181 deg  
 Reversal time: 0.502 s

## APPENDIX D

### Time History Plots

## LIST OF FIGURES

	Page
D1. Vehicle Speed, Handwheel Angle, and Roll Angle Time History Plots for Default Test Series, L-R, 50 mph .....	D-3
D2. Steering Machine Operation Time History Plots for Default Test Series, L-R, 50 mph.....	D-4
D3. Yaw Rate, Roll Rate, and Lateral Acceleration Time History Plots for Default Test Series, L-R, 50 mph .....	D-5
D4. Pitch Rate and Longitudinal Acceleration Time History Plots for Default Test Series, L-R, 50 mph .....	D-6
D5. Vehicle Speed, Handwheel Angle, and Roll Angle Time History Plots for Default Test Series, R-L, 50 mph .....	D-7
D6. Steering Machine Operation Time History Plots for Default Test Series, R-L, 50 mph .....	D-8
D7. Yaw Rate, Roll Rate, and Lateral Acceleration Time History Plots for Default Test Series, R-L, 50 mph .....	D-9
D8. Pitch Rate and Longitudinal Acceleration Time History Plots for Default Test Series, R-L, 50 mph .....	D-10
D9. Vehicle Speed, Handwheel Angle, and Roll Angle Time History Plots for Supplemental 2 Test Series, L-R, 50 mph.....	D-11
D10. Steering Machine Operation Time History Plots for Supplemental 2 Test Series, L-R, 50 mph .....	D-12
D11. Yaw Rate, Roll Rate, and Lateral Acceleration Time History Plots for Supplemental 2 Test Series, L-R, 50 mph .....	D-13
D12. Pitch Rate and Longitudinal Acceleration Time History Plots for Supplemental 2 Test Series, L-R, 50 mph .....	D-14
D13. Vehicle Speed, Handwheel Angle, and Roll Angle Time History Plots for Supplemental 2 Test Series, R-L, 50 mph.....	D-15
D14. Steering Machine Operation Time History Plots for Supplemental 2 Test Series, R-L, 50 mph .....	D-16
D15. Yaw Rate, Roll Rate, and Lateral Acceleration Time History Plots for Supplemental 2 Test Series, R-L, 50 mph .....	D-17
D16. Pitch Rate and Longitudinal Acceleration Time History Plots for Supplemental 2 Test Series, R-L, 50 mph .....	D-18

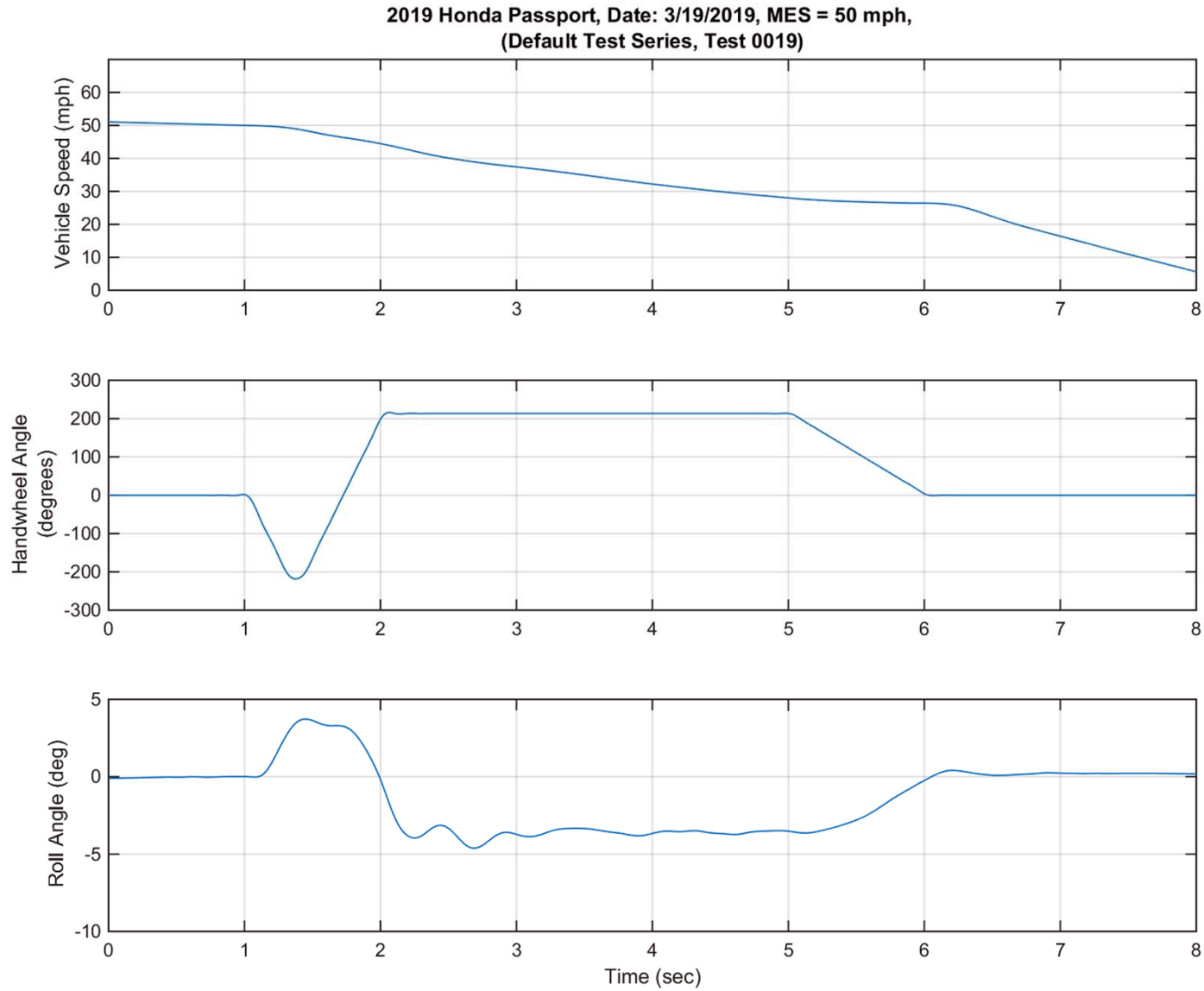

Figure D1. Vehicle Speed, Handwheel Angle, and Roll Angle Time History Plots for Default Test Series, L-R, 50 mph



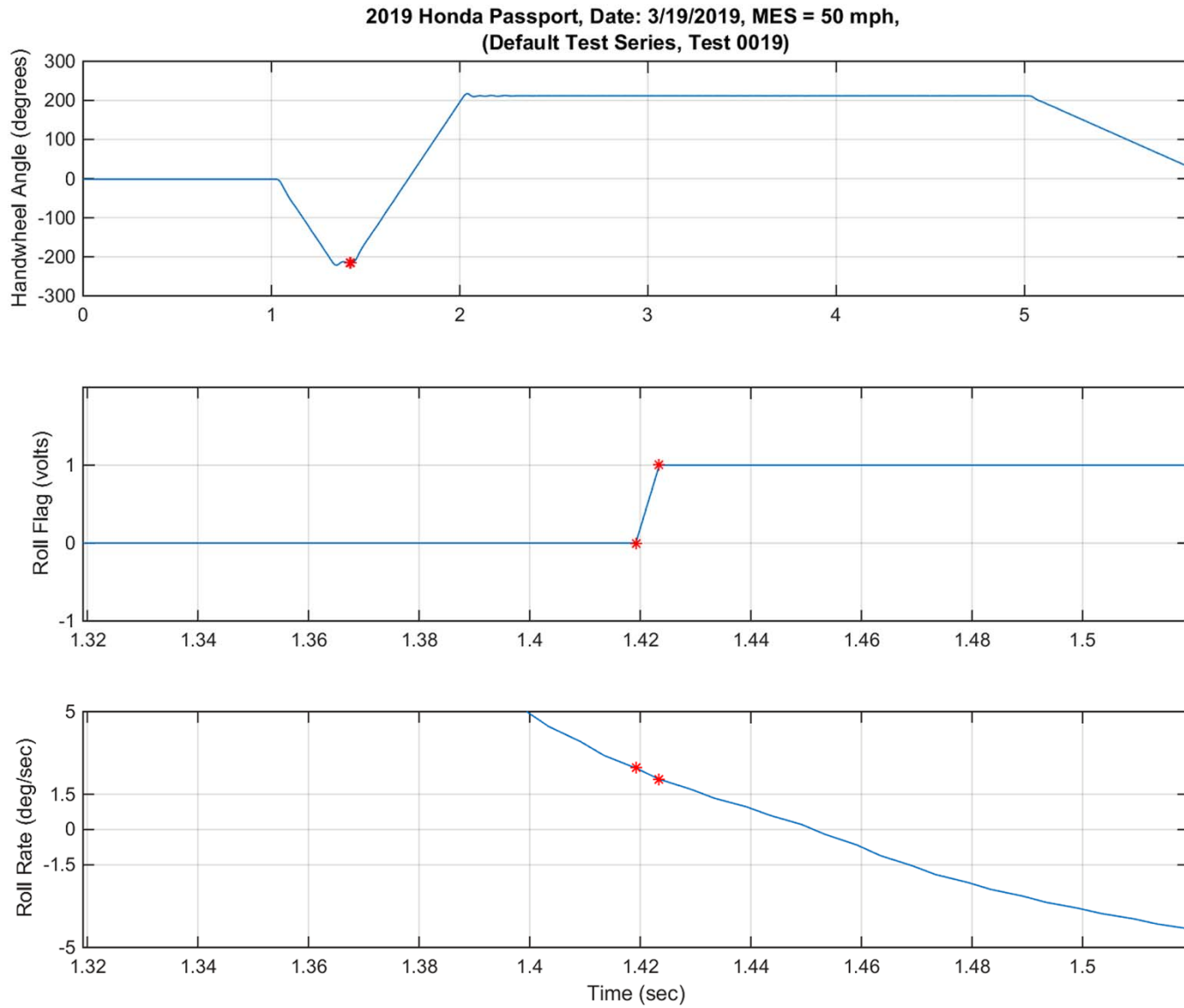

Figure D2. Steering Machine Operation Time History Plots for Default Test Series, L-R, 50 mph

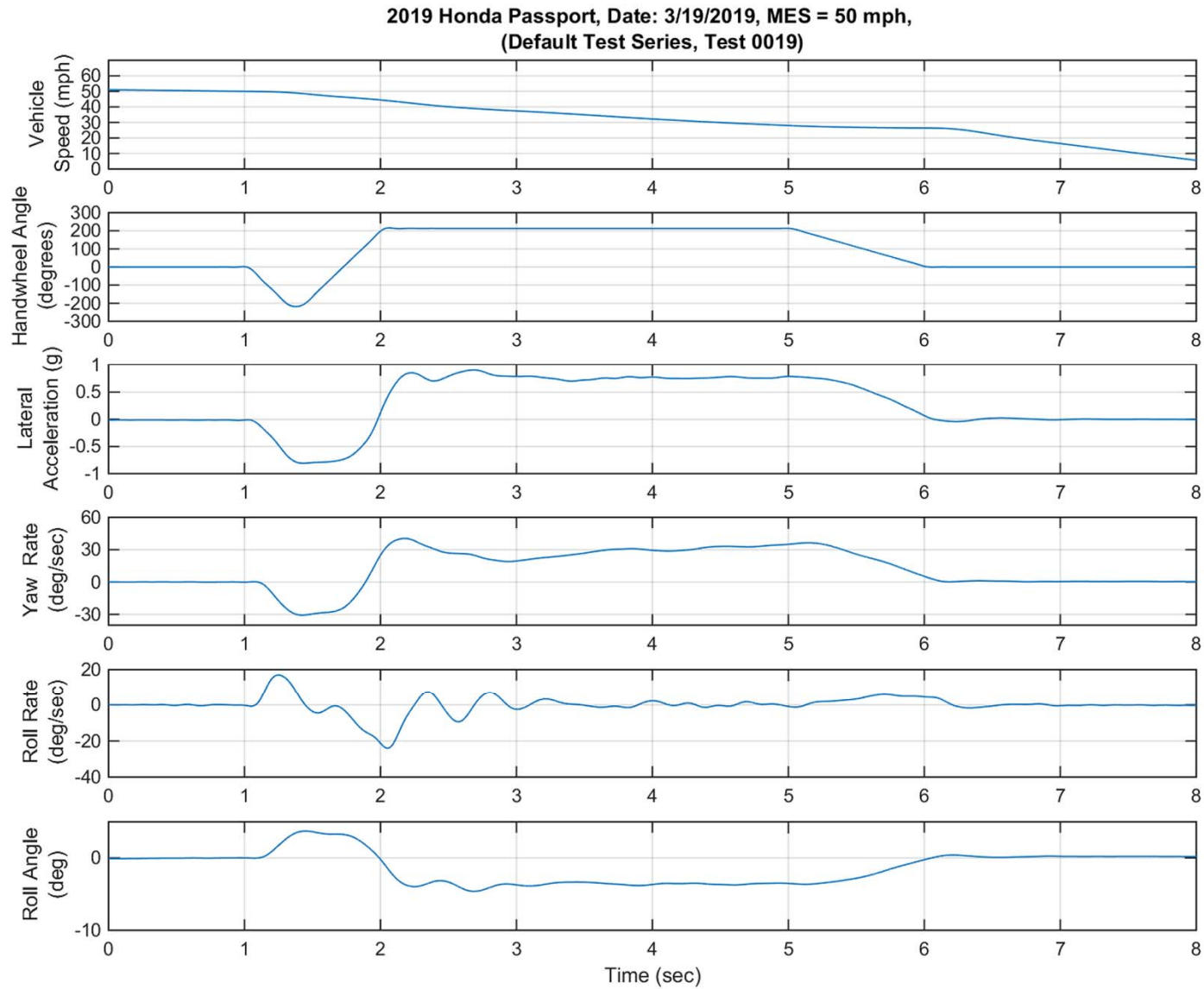

Figure D3. Yaw Rate, Roll Rate, and Lateral Acceleration Time History Plots For Default Test Series, L-R, 50 mph

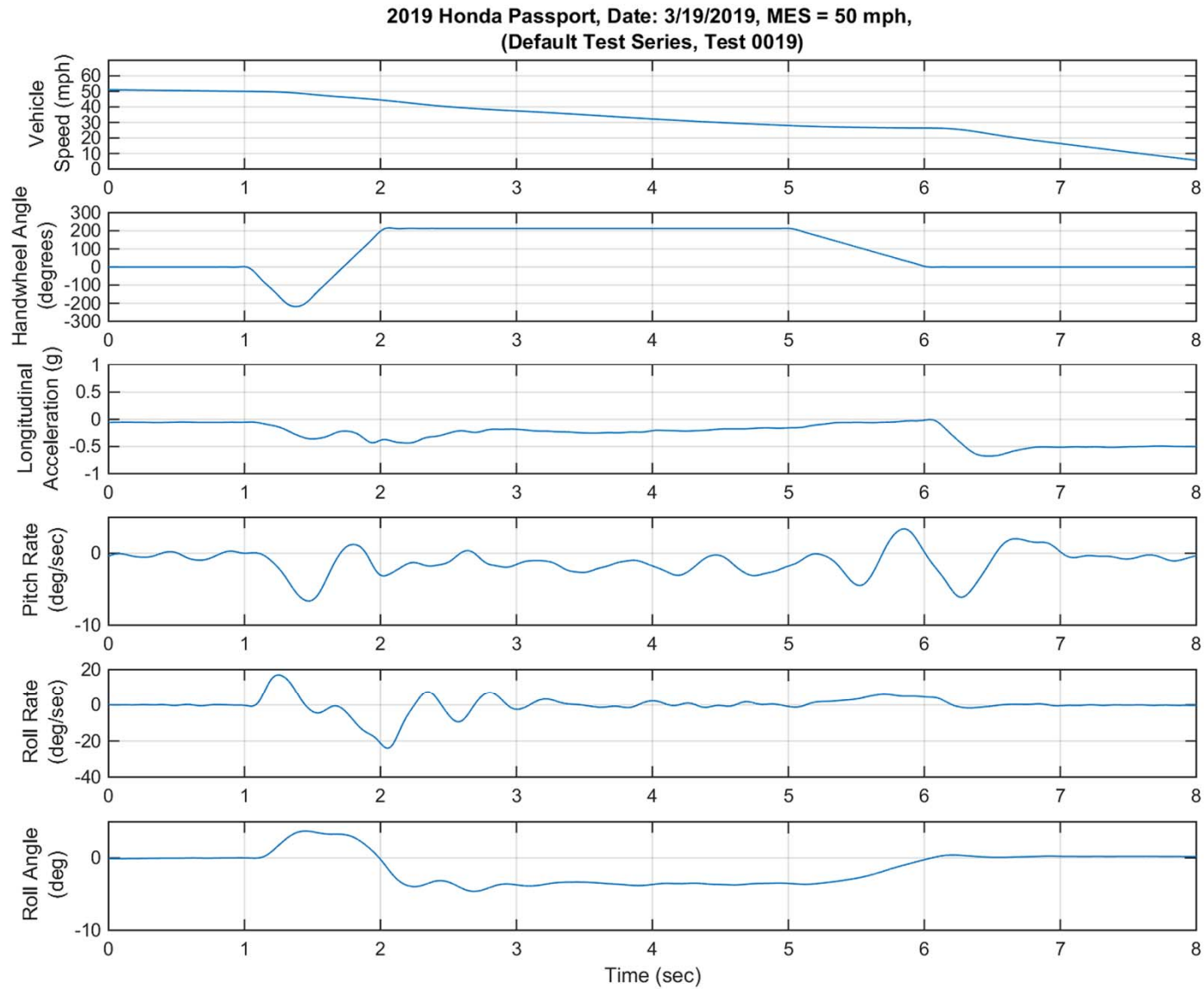

Figure D4. Pitch Rate and Longitudinal Acceleration Time History Plots for Default Test Series, L-R, 50 mph

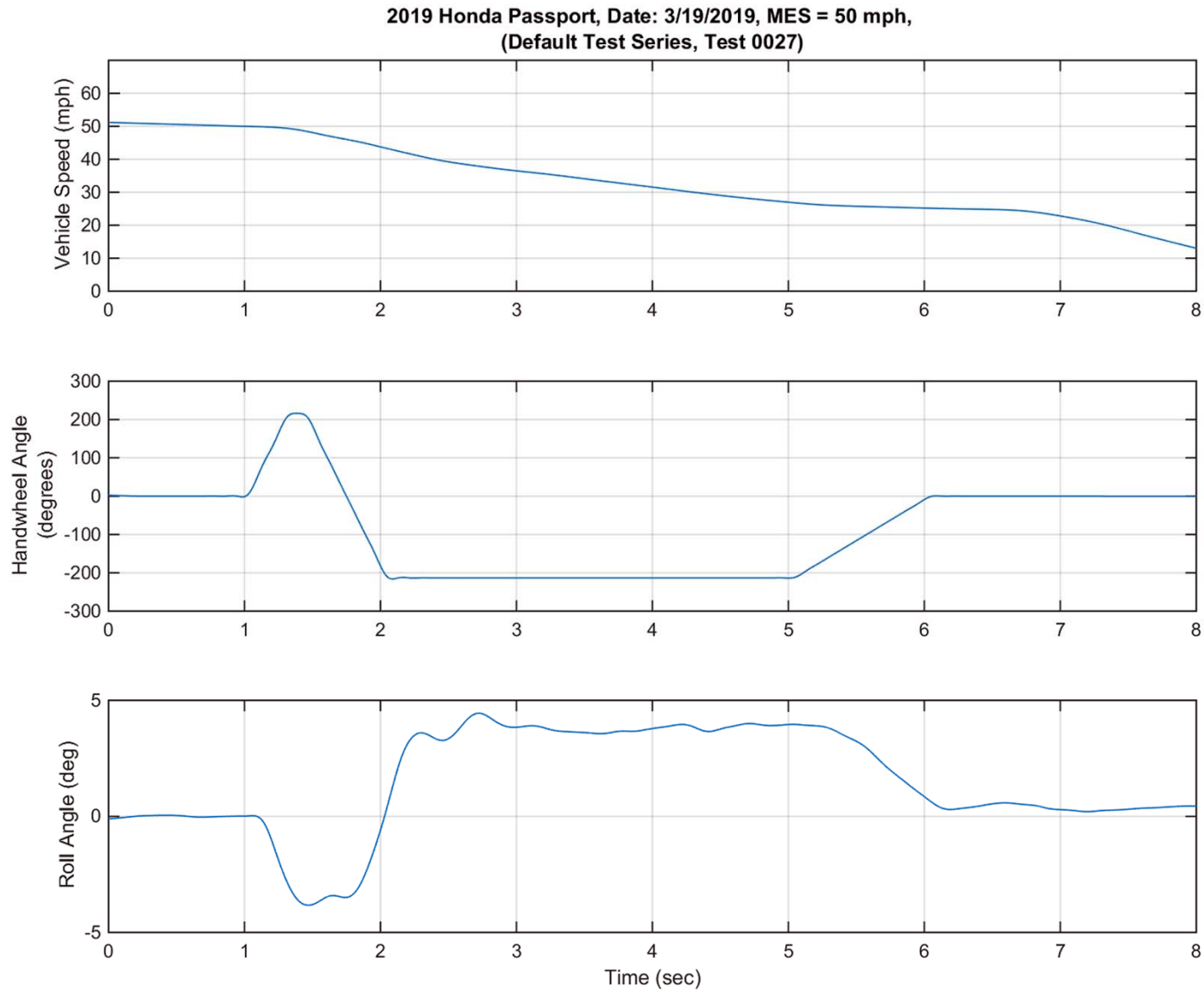

Figure D5. Vehicle Speed, Handwheel Angle, and Roll Angle Time History Plots for Default Test Series, R-L, 50 mph

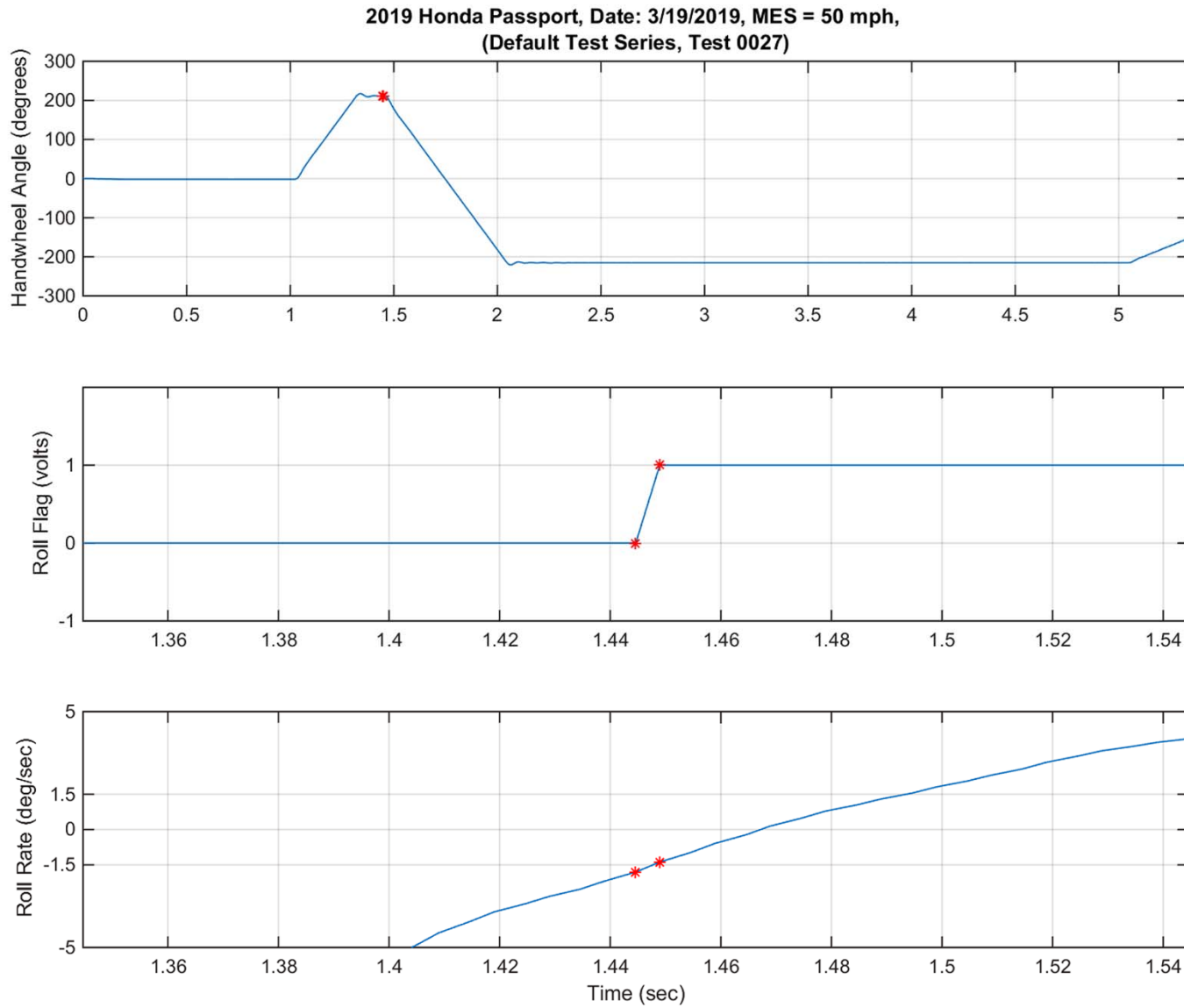

Figure D6. Steering Machine Operation Time History Plots for Default Test Series, R-L, 50 mph

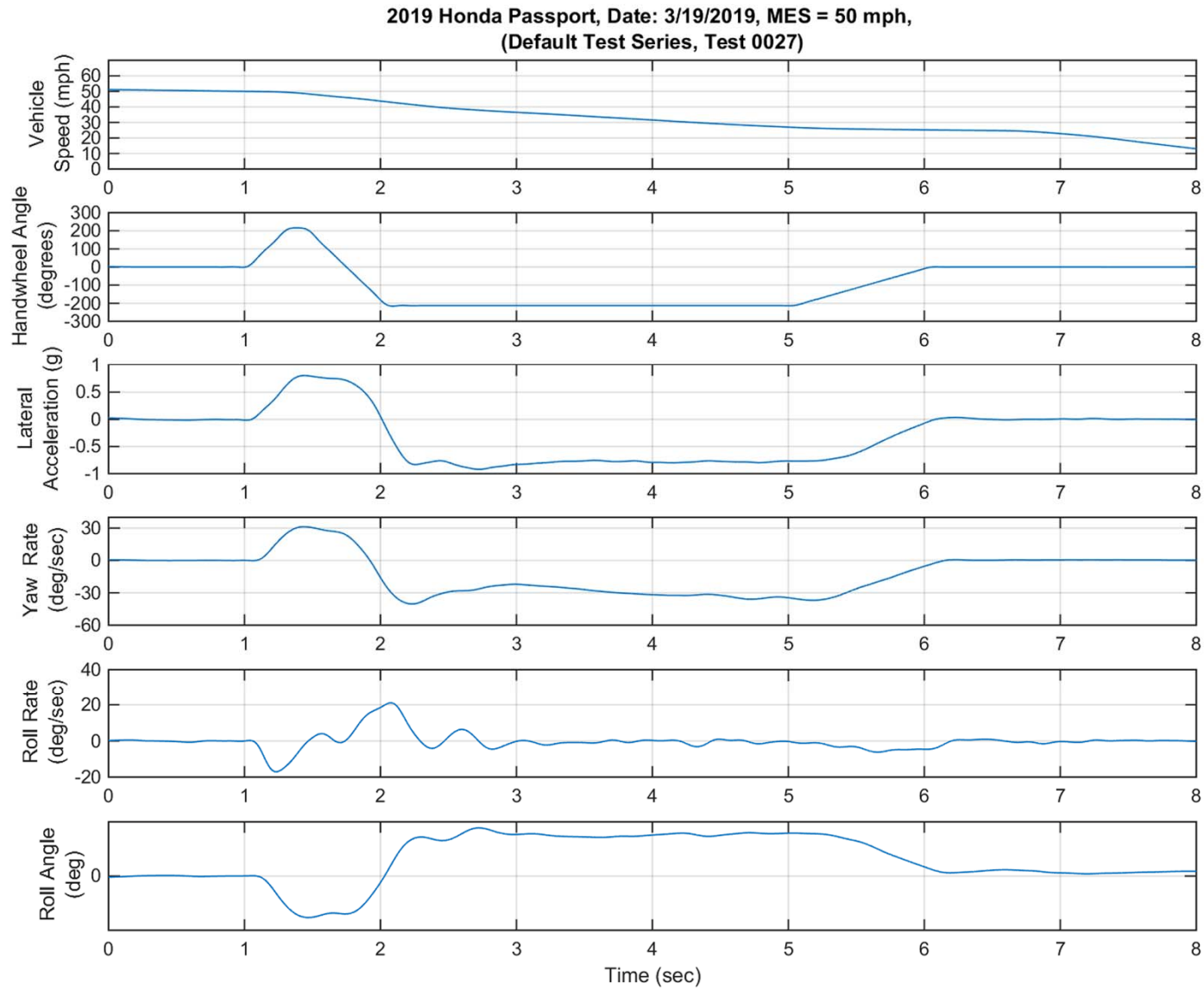

Figure D7. Yaw Rate, Roll Rate, and Lateral Acceleration Time History Plots for Default Test Series, R-L, 50 mph

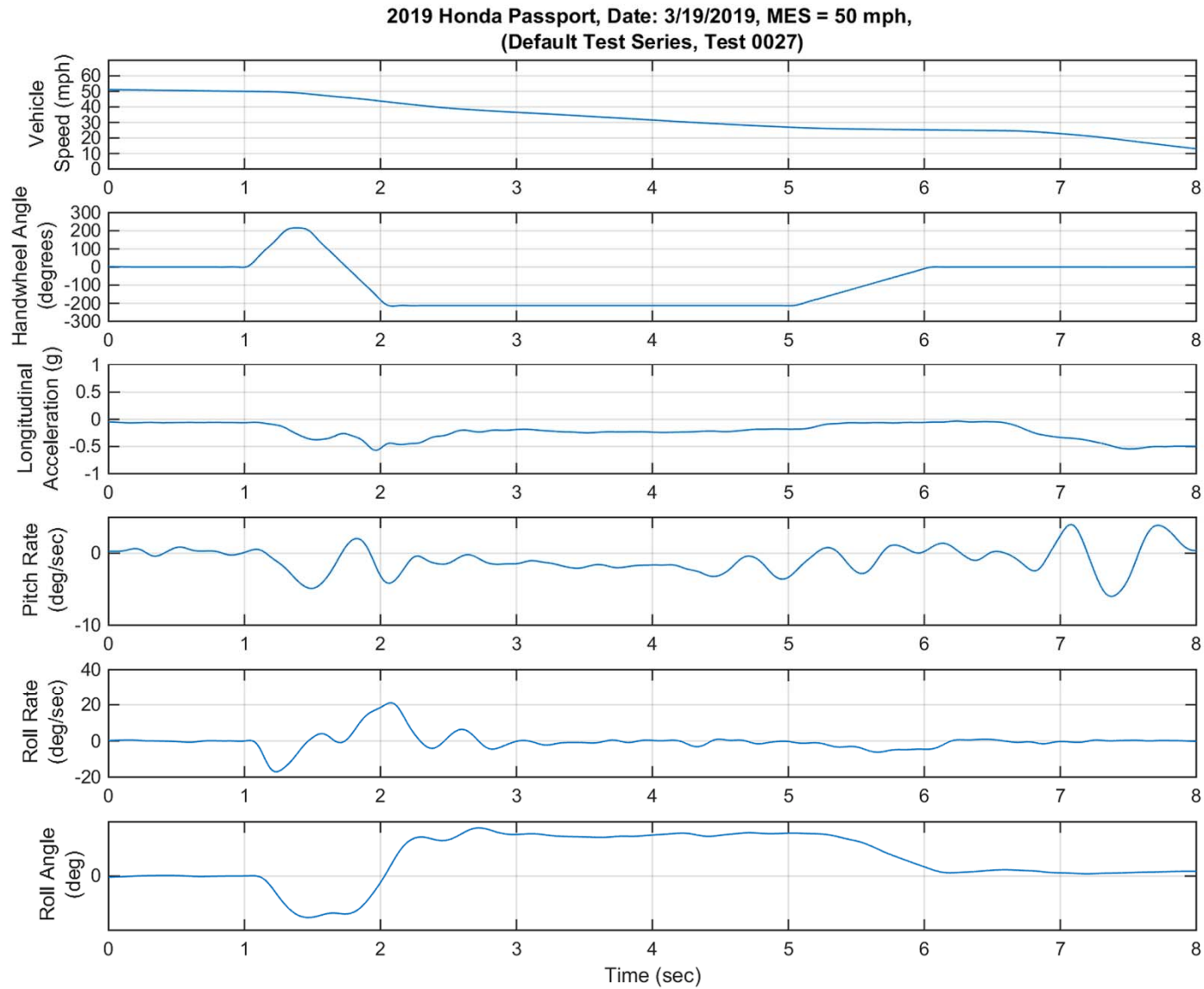

Figure D8. Pitch Rate and Longitudinal Acceleration Time History Plots or Default Test Series, R-L, 50 mph

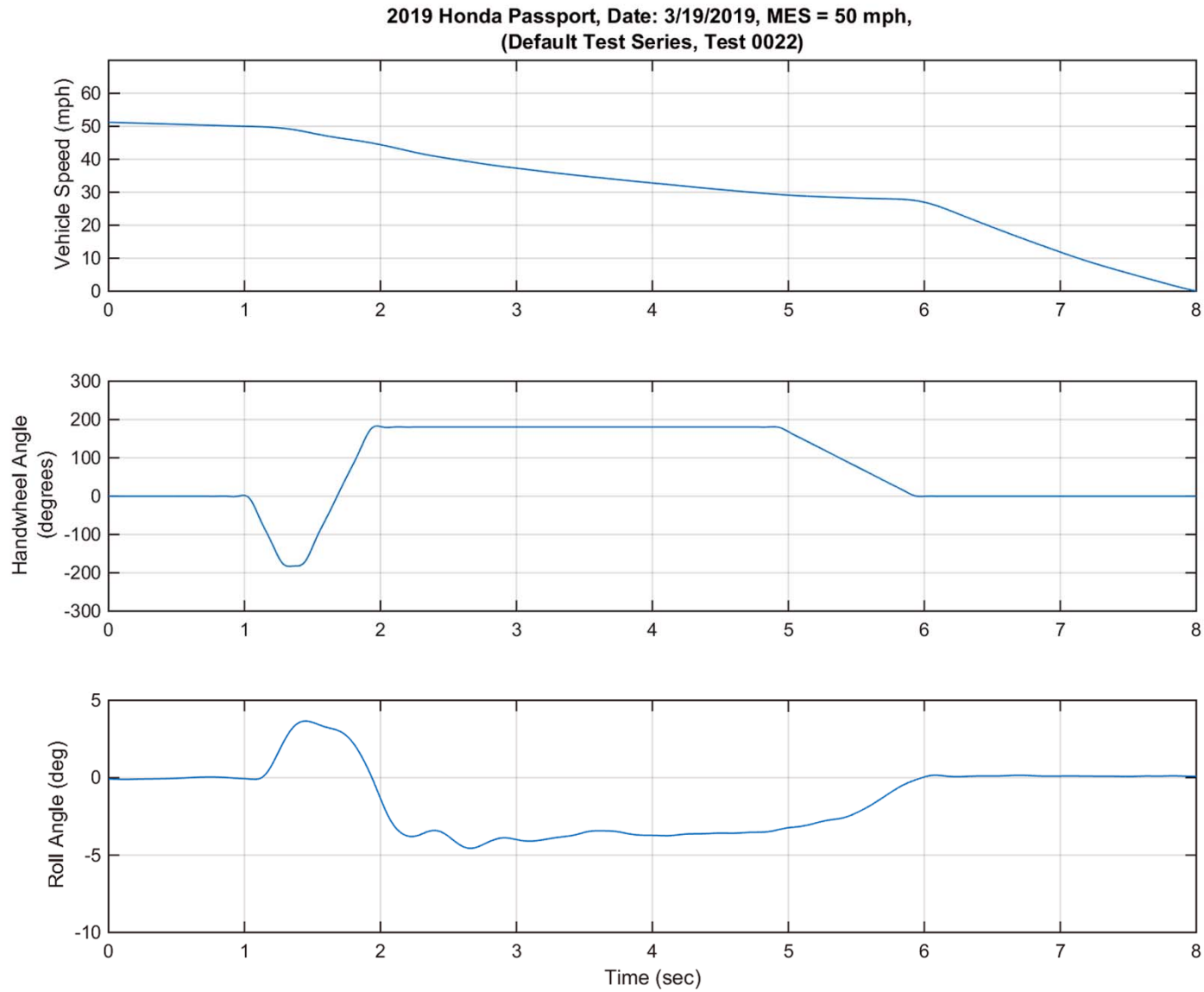

Figure D9. Vehicle Speed, Handwheel Angle, and Roll Angle Time History Plots for Supplemental 2 Test Series, L-R, 50 mph



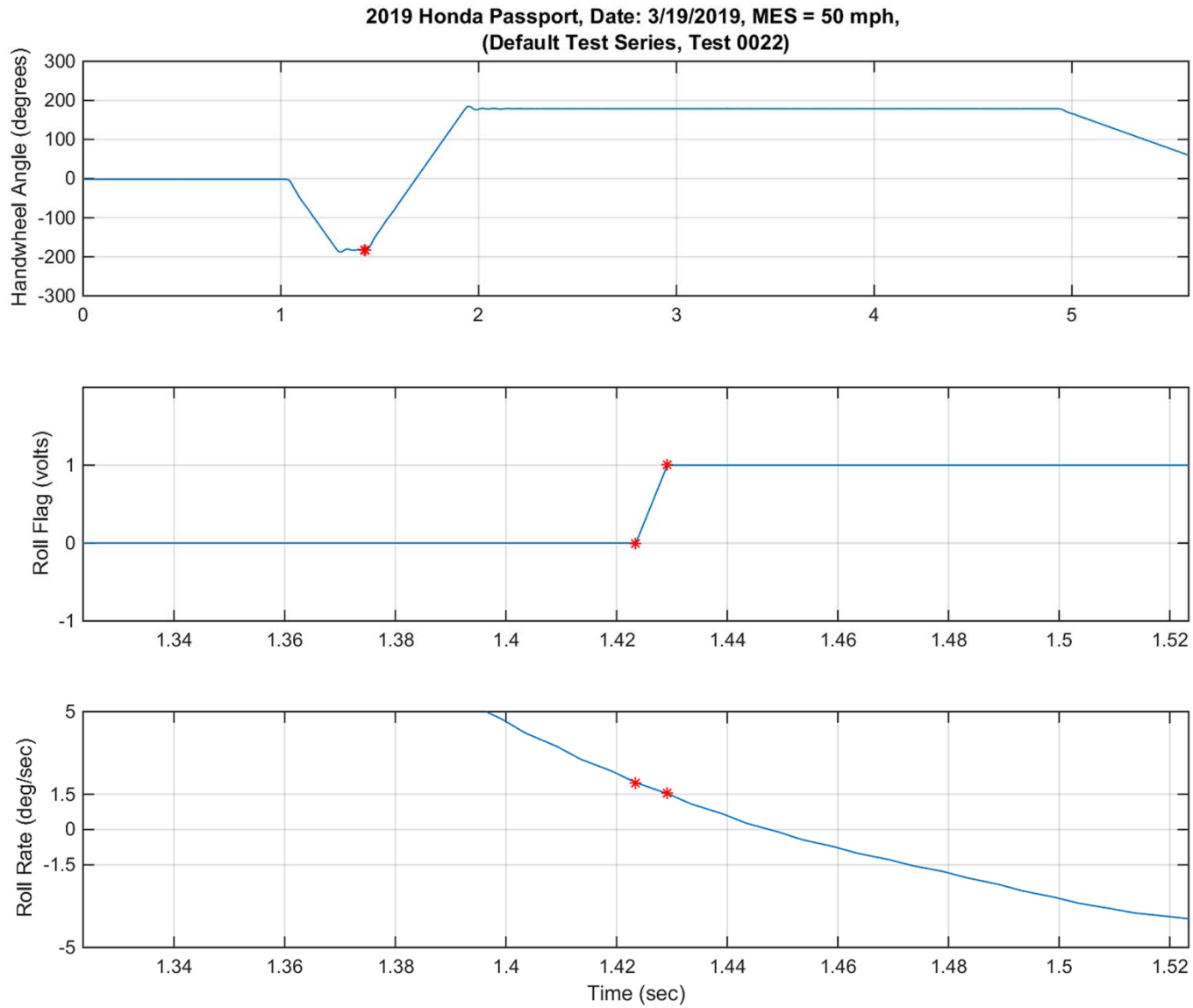

Figure D10. Steering Machine Operation Time History Plots for Supplemental 2 Test Series, L-R, 50 mph

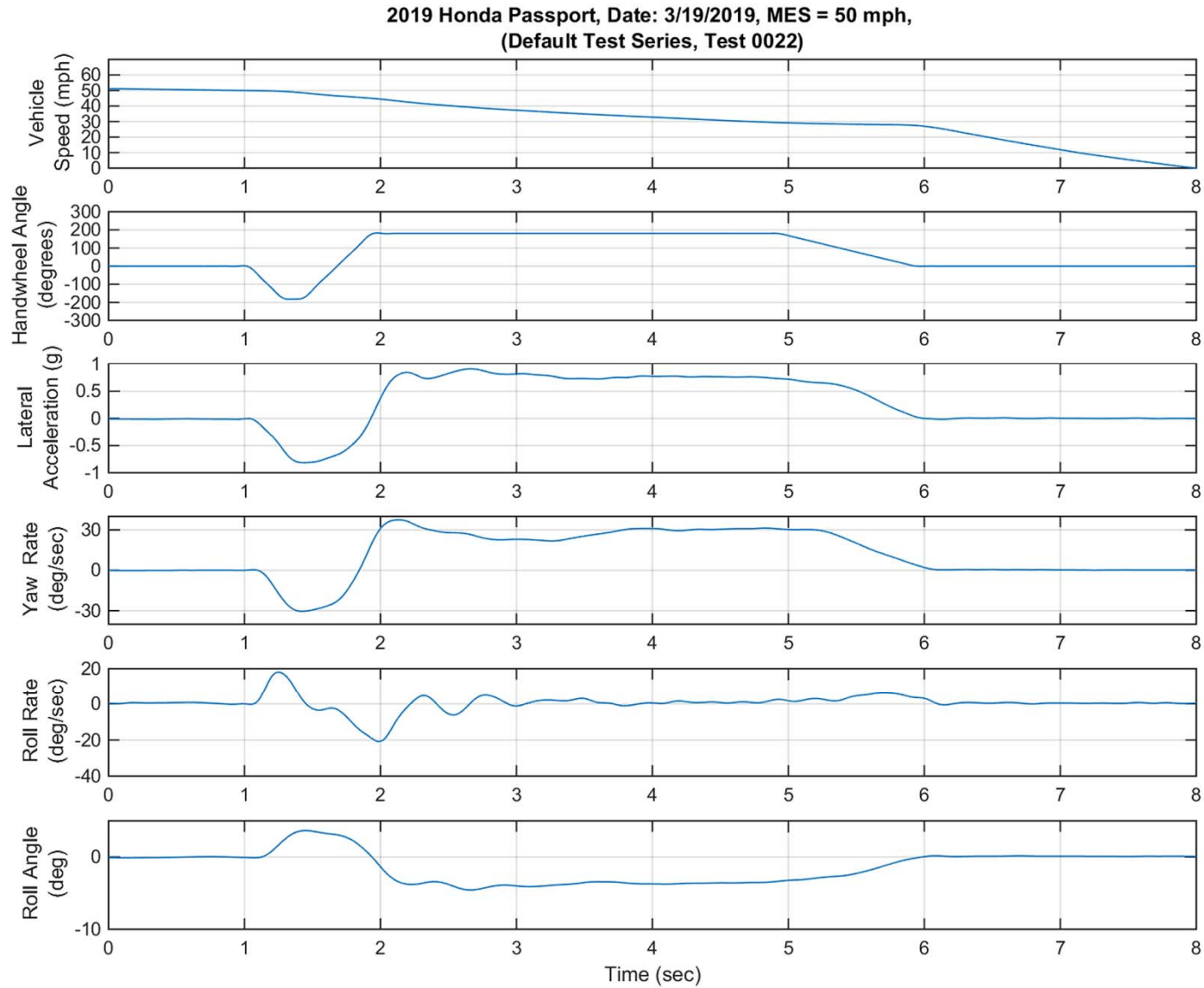

Figure D11. Yaw Rate, Roll Rate, and Lateral Acceleration Time History Plots for Supplemental 2 Test Series, L-R, 50 mph

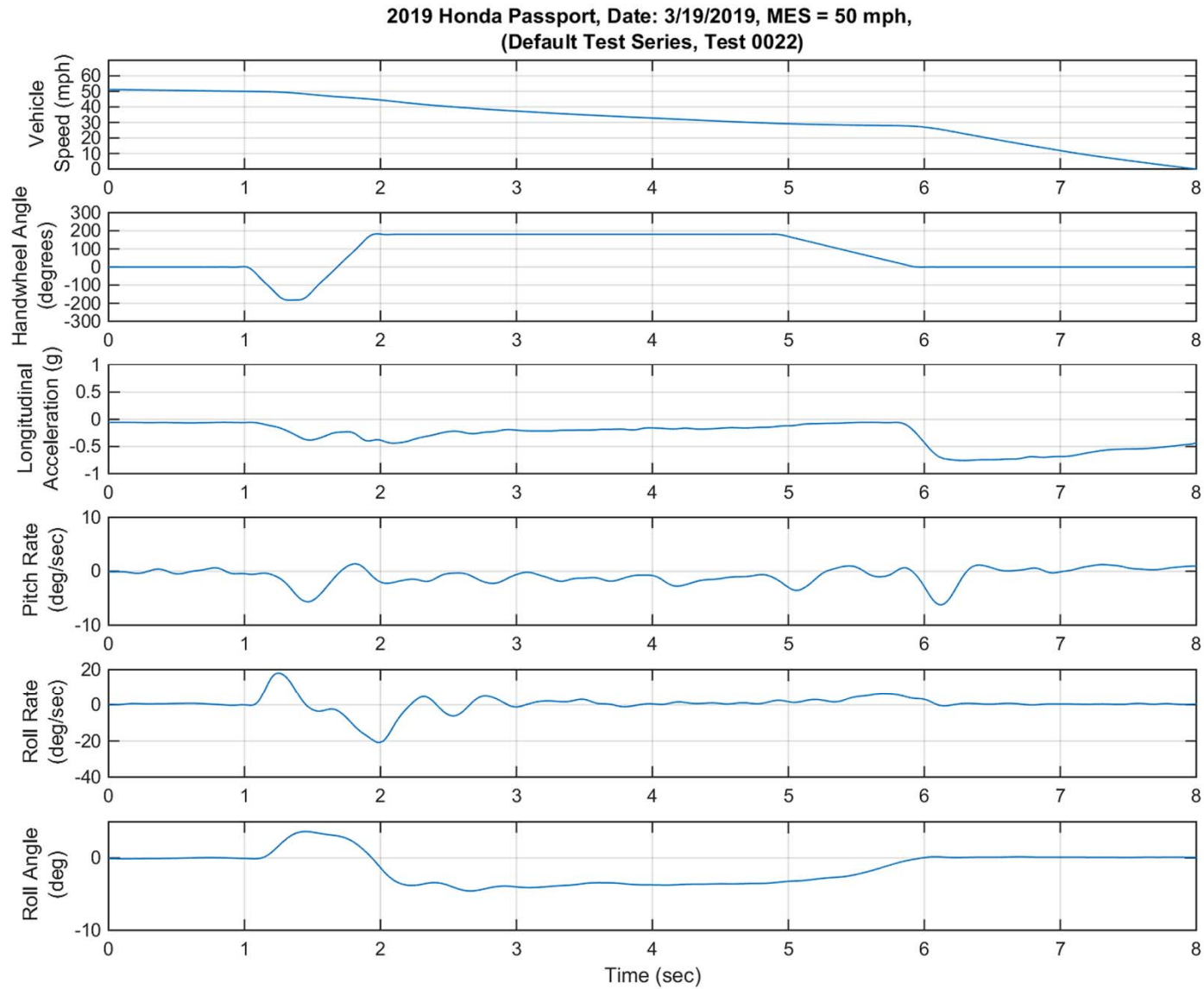

Figure D12. Pitch Rate and Longitudinal Acceleration Time History Plots for Supplemental 2 Test Series, L-R, 50 mph

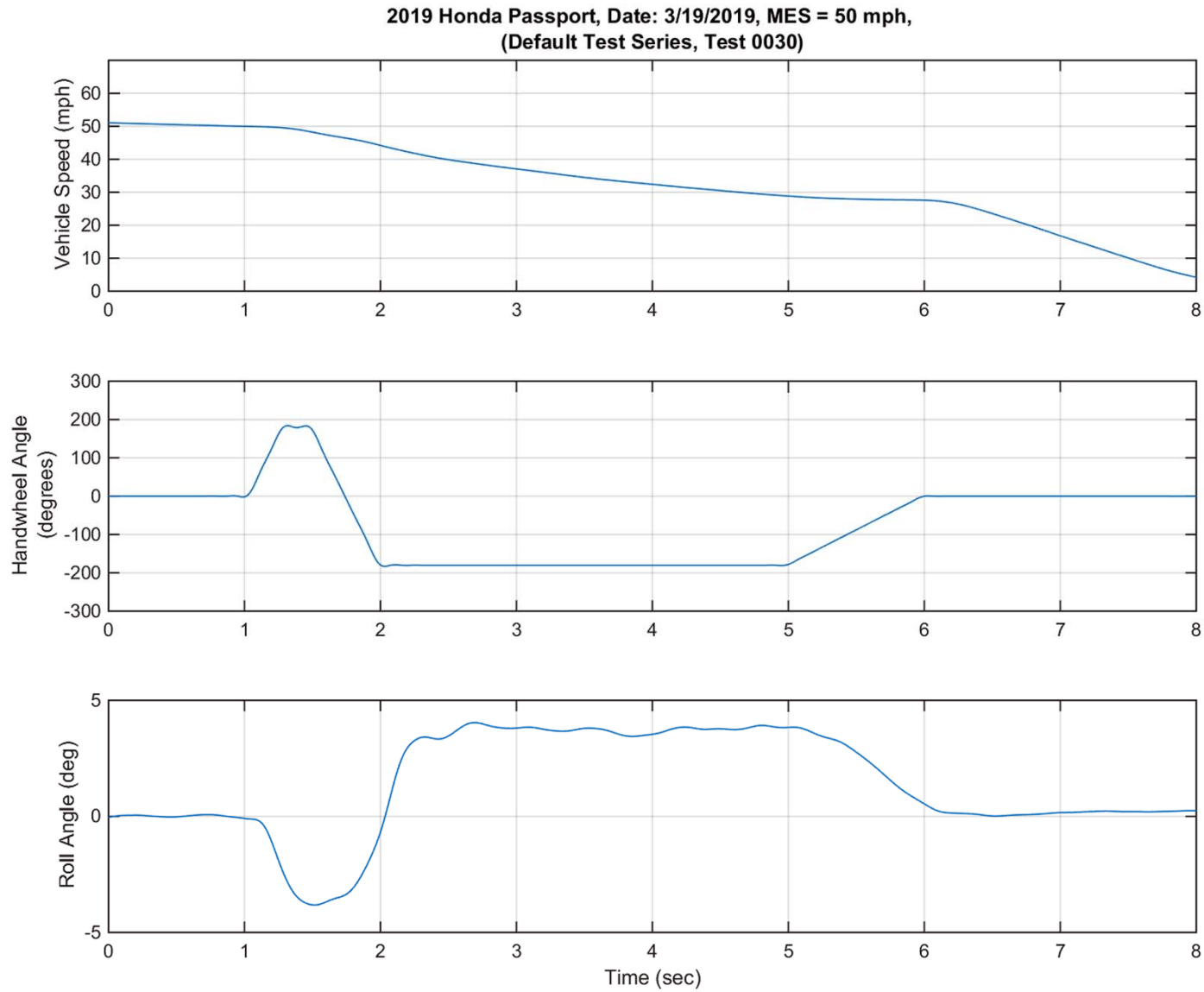

Figure D13. Vehicle Speed, Handwheel Angle, and Roll Angle Time History Plots for Supplemental 2 Test Series, R-L, 50 mph

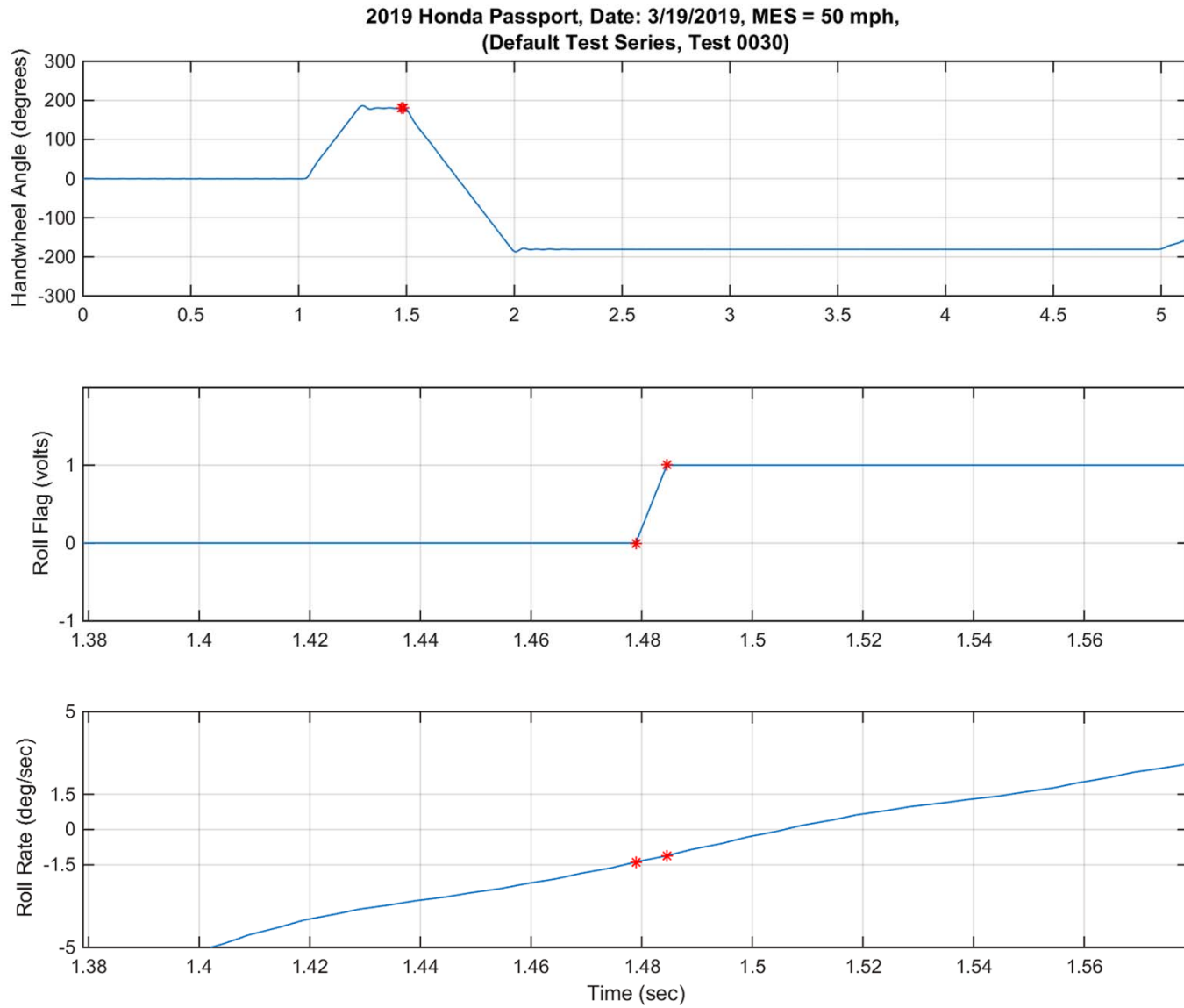

Figure D14. Steering Machine Operation Time History Plots for Supplemental 2 Test Series, R-L, 50 mph

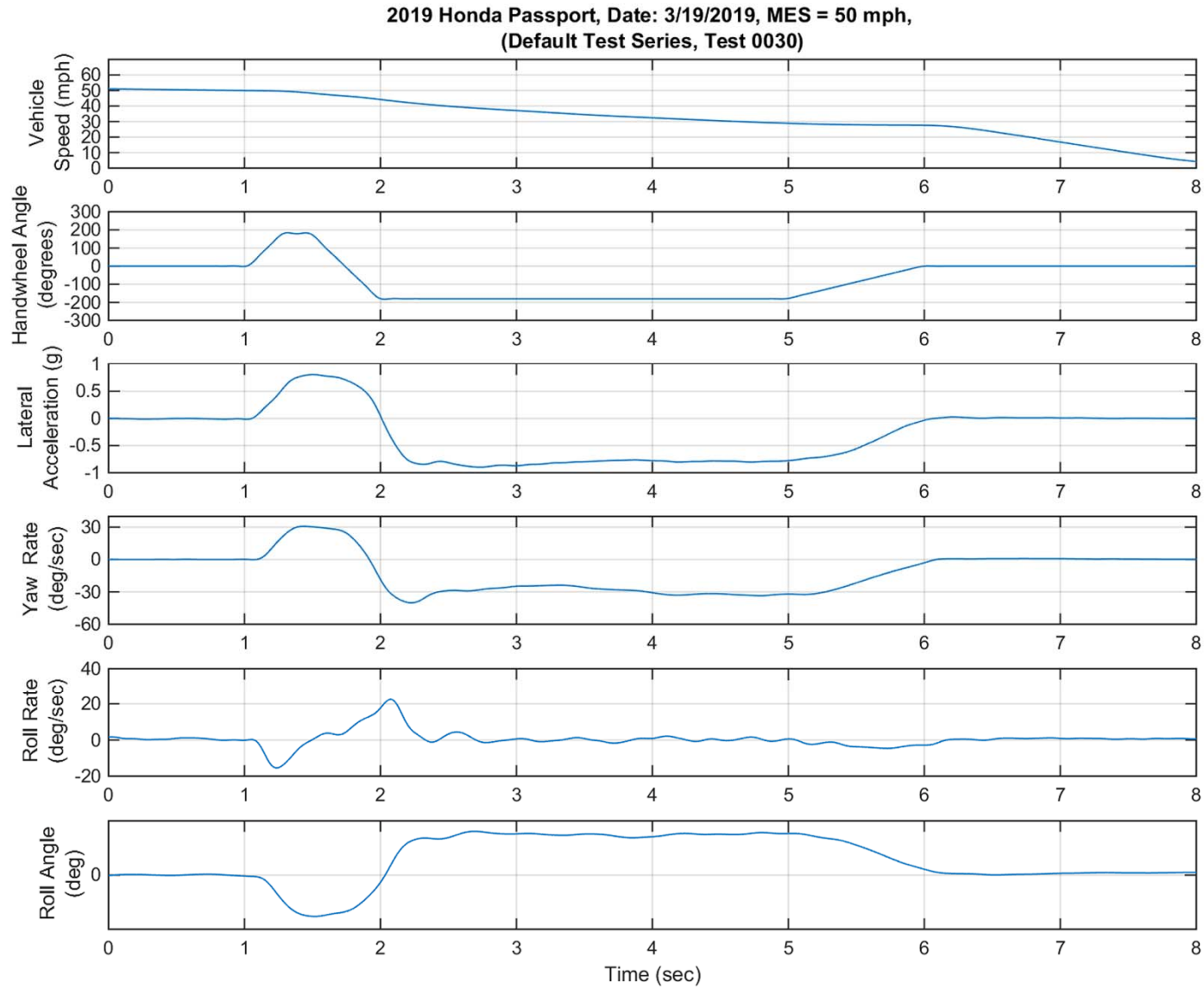

Figure D15. Yaw Rate, Roll Rate, and Lateral Acceleration Time History Plots for Supplemental 2 Test Series, R-L, 50 mph

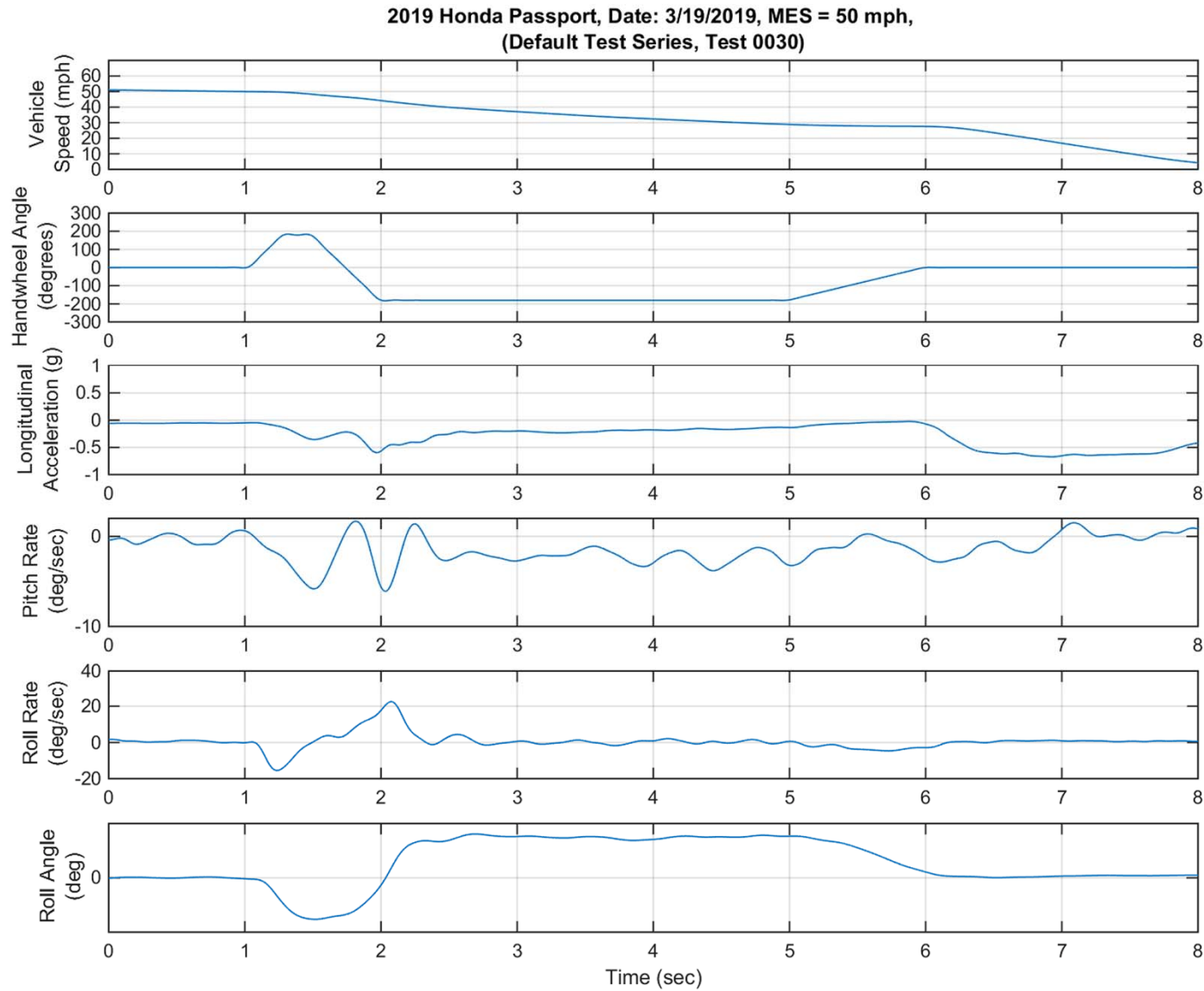

Figure D16. Pitch Rate and Longitudinal Acceleration Time History Plots for Supplemental 2 Test Series, R-L, 50 mph